

22102123251

Med

K30312









84916.

1887C.

*Geralt W. W.*

GENERAL PHYSIOLOGY

OF

MUSCLES AND NERVES

BY

DR I. ROSENTHAL

PROFESSOR OF PHYSIOLOGY IN THE UNIVERSITY OF ERLANGEN

*WITH SEVENTY-FIVE WOODCUTS*

THIRD EDITION

LONDON

KEGAN PAUL, TRENCH, & CO., 1 PATERNOSTER SQUARE

1883

17730

27874362

WELLCOME INSTITUTE LIBRARY	
Call	welw@nec
Call	
No	WE

*(The rights of translation and of reproduction are reserved)*

THIS BOOK IS DEDICATED

TO

HIS VENERATED MASTER

EMIL DU BOIS-REYMOND

BY

THE AUTHOR



## PREFACE.

---

THIS attempt at a connected account of the General Physiology of Muscles and Nerves is, as far as I know, the first of its kind. The necessary data for this branch of science have been gained only within the last thirty years, and even now many of the facts are uncertain and have been insufficiently studied. Under these circumstances it might well be asked if the time has yet come for such an account as this. But anyone who endeavours to gain an idea of this branch of knowledge from the existing text-books of Physiology will probably labour in vain. Moreover, the subject is one which has many points of interest not only for the specialist, but also for the physicist, for the psychologist, and indeed for every cultivated man; and as regards the gaps in our knowledge, they are scarcely greater than those in any other branch of the science of life.

There being no previous writers on the same subject, I have been obliged to depend entirely on myself in the matter of the arrangement, in the selection of important points and the rejection of those of less importance, and as to the form in which the subject

is presented. From the experience gained by teaching during more than fifteen years, I believe that I have acquired sufficient clearness of expression, even in treating of more difficult matters, to be intelligible when studied carefully even by those who are not specialists. In certain cases it has been impossible to avoid somewhat long explanations of physical and, especially, of electric phenomena. But these have been confined to the narrowest possible limits, and I must refer those who require further details to my *Elektricitätslehre für Mediciner* (Berlin, Hirschwald). It has also been unavoidable in giving an account of one branch of Physiology to indicate the connection with other branches, though it has been impossible to enter into the details of these. To those who feel inclined to follow these matters further, I recommend the study of Huxley's 'Elementary Physiology.' Certain details, which would have detained the course of the text too long, I have relegated to the Notes and Additions at the end of the book.

In accordance with the title of the book, I have omitted too scientific proofs, references, &c. The names of men of science to whom the discovery of the facts is due have only been occasionally introduced. In this matter no fixed rule has been followed, but it did not seem right to omit occasional mention of the names of the chief founders of this branch of knowledge—Ed. Weber, E. du Bois-Reymond, and H. Helmholtz.

ERLANGEN: April 15, 1877.



# CONTENTS.



PREFACE . . . . .	PAGE vii
-------------------	-------------

## CHAPTER I.

1. Introduction: Motion and sensation as animal characteristics; 2. Movement in plants; 3. Molecular motion; 4. Simplicity of the lowest organisms; 5. Protoplasmic motion and amoeboid motion; 6. Elementary organisms and gradual differentiation of the tissues; 7. Ciliary motion . . . . .	1
---	---

## CHAPTER II.

1. Muscles, their form and structure; 2. Minute structure of striated muscle-fibres; 3. Connection of muscles and bones; 4. Bones and bone-sockets; 5. The law of elasticity; 6. The elasticity of the muscles . . . . .	12
--	----

## CHAPTER III.

1. Irritability of muscle; 2. Contraction and tetanus; 3. Height of elevation and performance of work; 4. Internal work during tetanus; 5. Generation of heat and muscle-tone; 6. Alteration in form during contraction . . . . .	28
---	----

## CHAPTER IV.

1. Alteration in elasticity during contraction; 2. Duration of contraction; the myograph; 3. Determination of electric	
--	--

	PAGE
time; 4. Application of this to muscular pulsation; 5. Burden and over-burden, muscular force; 6. Determination of muscular force in man; 7. Alteration in muscular force during contraction . . . . .	47

### CHAPTER V.

1. Chemical processes within the muscle; 2. Generation of warmth during contraction; 3. Exhaustion and recovery; 4. Source of muscle-force; 5. Death of the muscle; 6. Death-stiffening ( <i>Rigor mortis</i> ) . . . . .	72
---	----

### CHAPTER VI.

1. Forms of muscle; 2. Attachment of muscles to the bones; 3. Elastic tension; 4. Smooth muscle-fibres; 5. Peristaltic motion; 6. Voluntary and involuntary motion . . . . .	91
--	----

### CHAPTER VII.

1. Nerve-fibres and nerve-cells; 2. Irritability of nerve-fibre; 3. Transmission of the irritation; 4. Isolated transmission; 5. Irritability; 6. The curve of irritation; 7. Exhaustion and recovery, death . . . . .	103
--	-----

### CHAPTER VIII.

1. Electrotonus; 2. Modifications of excitability; 3. Law of pulsations; 4. Connection of electrotonus with excitability; 5. Condition of excitability in electrotonus; 6. Explanation of the law of pulsations; 7. General law of nerve-excitement . . . . .	125
---	-----

### CHAPTER IX.

1. Electric phenomena; 2. Electric fishes; 3. Electric organs; 4. Multiplier and tangent galvanometer; 5. Difficulty of the study; 6. Homogeneous diverting vessels; 7. Electromotive force; 8. Electric fall; 9. Tension in the closing arch . . . . .	153
---	-----

## CHAPTER X.

	PAGE
1. Diverting arches; 2. Current-curves and tension-curves; 3. Diverting cylinders; 4. Method of measuring tension differences by compensation . . . . .	176

## CHAPTER XI.

i. A regular muscle-prism; 2. Currents and tensions in a muscle-prism; 3. Muscle-rhombus; 4. Irregular muscle- rhombi; 5. Current of <i>m. gastrocnemius</i> . . . . .	189
--	-----

## CHAPTER XII.

1. Negative variation of the muscle-current; 2. Living muscle is alone electrically active; 3. Parelectronomy; 4. Sec- ondary pulsation and secondary tetanus; 5. Glands and their currents . . . . .	202
--	-----

## CHAPTER XIII.

1. The nerve-current; 2. Negative variation of the nerve- current; 3. Duplex transmission in the nerve; 4. Rate of propagation of negative variation; 5. Electrotonus; 6. Electric tissue of electric fishes; 7. Electric action in plants	215
---	-----

## CHAPTER XIV.

1. General summary; 2. Fundamental principles; 3. Com- parison of muscle-prism and magnet; 4. Explanation of the tensions in muscle-prisms and muscle-rhombi; 5. Explanation of negative variation and parelectronomy; 6. Application to nerves; 7. Application to electric organs and glands . . . . .	226
--	-----

## CHAPTER XV.

1. Connection of nerve and muscle; 2. Isolated excitement of individual muscle-fibres; 3. Discharge-hypothesis; 4. Prin-	
---	--

	PAGE
principle of the dispersion of forces; 5. Independent irritability of muscle-substance; 6. Curare; 7. Chemical irritants; 8. Theory of the activity of the nerves . . . . .	244

## CHAPTER XVI.

1. Various kinds of nerves; 2. Absence of indicable differences in the fibres; 3. Characters of nerve-cells; 4. Various kinds of nerve-cells; 5. Voluntary and automatic motion; 6. Reflex motion and co-relative sensation; 7. Sensation and consciousness; 8. Retardation; 9. Specific energies of nerve-cells; 10. Conclusion. . . . .	261
---	-----

---

## NOTES AND ADDITIONS.

1. Graphical Representation. Mathematical Function . . . . .	293
2. Irritation of Muscle-Fibres, Height of Elevation and Performance of Work . . . . .	297
3. Excitability and Strength of Irritant. Combination of Irritants . . . . .	299
4. Curve of Excitability. Resistance to Transmission . . . . .	300
5. Influence of the Length of Irritated Portion of Nerve . . . . .	303
6. Difference between closing and opening Inductive Currents. Helmholtz's Arrangement . . . . .	304
7. Effect of Currents of Short Duration . . . . .	307
8. Unipolar Irritation . . . . .	309
9. Tangent Galvanometer . . . . .	310
10. Tensions in Conductors . . . . .	311
11. Duplex Transmission. Degeneration, Regeneration, and Healing of Bisected Nerves . . . . .	312
12. Negative Variation and Excitement . . . . .	313
13. Electrotonus. Secondary Pulsations effected by Nerves. Paradoxical Pulsation . . . . .	314
14. Parelectromy . . . . .	315
15. Discharge Hypothesis and Isolated Transmission in Nerve-Fibre . . . . .	316
INDEX . . . . .	319

## LIST OF WOODCUTS.

FIG.	PAGE
1. Amœbæ . . . . .	6
2. White Blood-Corpuscles from a Guinea-Pig . . . . .	7
3a. Ciliate Cells situated with the other Cells on a Membrane . . . . .	10
3b. A single Ciliate Cell, greatly magnified, of somewhat abnormal form . . . . .	10
4. Striated Muscle-Fibres . . . . .	13
5. The Double-headed Calf-Muscle ( <i>m. gastrocnemius</i> ) with its Tendons . . . . .	17
6. The Bones of the Arm . . . . .	19
7. Du Bois-Reymond's Apparatus for studying the Elastic Extension in Muscle . . . . .	25
8. The Simple Myograph . . . . .	26
9. Du Bois-Reymond's Muscle-Telegraph . . . . .	29
10. Induction Coil . . . . .	31
11. Electric Wheel . . . . .	33
12. Wagner's Hammer . . . . .	34
13. Du Bois-Reymond's Sliding Inductive Apparatus . . . . .	35
14. Du Bois-Reymond's Tetanising Key . . . . .	36
15. Heights of Elevation with different Weights . . . . .	38
16. The Changes in Elasticity during Contraction . . . . .	48
17. Helmholtz's Myograph . . . . .	52
18. The Curve of Pulsation of a Muscle . . . . .	56
19. Measurement of small Angles of Deflection with Mirror and Lens . . . . .	57
20. Apparatus for measuring the Duration of Muscle-Contraction . . . . .	60
21. End of the Lever of the Time-determining Apparatus with Capsule of Quicksilver . . . . .	61
22. Diagram of Experiment for measuring Electric Time . . . . .	62
23. Diagram of the Flexor Apparatus of the Forearm . . . . .	68
24. Dynamometer . . . . .	69



	PAGE
25. Smooth Muscle-Fibres . . . . .	97
26. Nerve-Fibres . . . . .	104
27. Ganglion-Cells with Nerve-Processes . . . . .	106
28. Spring Myograph of E. du Bois-Reymond . . . . .	112
29. Propagation of the Excitement in the Nerve . . . . .	114
30. Electrotonus . . . . .	127
31. Electrotonus under the influence of Currents of varying Strength . . . . .	130
32. Rheochord . . . . .	133
33. Electrotonus . . . . .	140
34. Series of Magnetic Needles representing Nerve-Particles . . . . .	147
35. Rheochord . . . . .	149
36. Electric Current . . . . .	159
37. Multiplier . . . . .	161
38. Reflecting Galvanometer . . . . .	163
39. Du Bois-Reymond's homogeneous Diverting Vessel . . . . .	166
40. Distribution of Currents in Irregular Conductors . . . . .	170
41. Electric Fall . . . . .	172
42. Fall in different Wires . . . . .	173
43. Current-Paths in a Conductor . . . . .	175
44. Current-Curves and Tension-Curves . . . . .	178
45. Du Bois-Reymond's Diverting Cylinders . . . . .	181
46. Measurement by Compensation of Differences in Tension . . . . .	184
47. Du Bois-Reymond's Round Compensator . . . . .	186
48. Diagram of Electric Measurement by Round Compensator . . . . .	187
49. A Regular Muscle-Prism . . . . .	190
50. Currents in a Muscle-Prism . . . . .	192
51. Tensions on the Longitudinal and Cross Sections of a Regular Muscle-Prism . . . . .	193
52. Tensions in a Regular Muscle-Rhombus . . . . .	195
53. Currents in a Regular Muscle-Rhombus . . . . .	196
54. Currents in the Gastrocnemius . . . . .	200
55. Muscle-Current during Pulsation . . . . .	203
56. Deflection of the Magnetic Needle by the Will . . . . .	205
57 and 58. Secondary Pulsation . . . . .	210
59. Tension in Nerves . . . . .	217
60. Changes in Tension during Electrotonus . . . . .	220
61. Theory of Magnetism . . . . .	230
62. Diagram of a Piece of Muscle-Fibre . . . . .	231
63. Diagram of the Electric Action in an Aggregation of Muscle-Elements . . . . .	233
64. Diagram of an oblique Cross-Section . . . . .	234

## LIST OF WOODCUTS.

XV

	PAGE
65. Magnetic Induction . . . . .	242
66. Magnetic Induction . . . . .	243
67. Nerve-Terminations in the Muscles of a Guinea-Pig . . .	245
68. Ganglion-Cells from the Human Brain . . . . .	266
69. Graphical Representation of Muscle-Extension . . . . .	295
70. Representations of Positive and Negative Values . . . . .	296
71. Action of Oblique Muscle-Fibres . . . . .	297
72. The Sciatic Nerve and Calf-Muscle of a Frog . . . . .	302
73. Duration of Inductive Currents . . . . .	305
74. Helmholtz's Arrangement with a Sliding Inductive Apparatus . . . . .	307
75 <i>A, B, C.</i> Secondary Pulsation from the Nerves . . . . .	315





# GENERAL PHYSIOLOGY

OF

## MUSCLES AND NERVES.



### CHAPTER I.

1. Introduction:—Movement and sensation as animal characteristics; 2. Movement in plants; 3. Molecular movements; 4. Simplicity of the lowest organisms; 5. Protoplasmic and amœboid movements; 6. Elementary organisms, and the gradual differentiation of the tissues; 7. Ciliary movement.

1. The student who has elected to study the phenomena of life probably meets with no more attractive, and at the same time no harder task than that of explaining motion and sensation. It is especially in these phenomena that the distinction lies between animate and inanimate objects, between animals and plants. It is true that movements can be detected even in inanimate objects, and, indeed, according to the modern conception, all natural phenomena depend on motion, either on that of entire masses, or on that of the smallest particles of the masses. But the movements of animals are

of a different kind. The contraction of a polyp when touched and the voluntary movement of the human arm are phenomena of a peculiar kind, and result from circumstances quite other than those which cause the fall of a stone or the attraction and repulsion exercised between magnetic or electric masses. Moreover, sensation, such as we are conscious of in ourselves, and of the existence of which in other men and in animals we learn either from the statements or from the conduct of those others, seems to be entirely unrepresented in inanimate nature; it even appears doubtful if it occurs in plants. Upon this task, hard as it is, physiological research has thrown much light; it is the knowledge which has thus already been gained which will form the subject of the following explanations.

2. Although even in plants movements occur similar to those observable in animals, yet there seems to be an essential difference between the two. For instance, in most animals we find that special organs are formed to serve principally for movement. Such are the muscles, which form what is ordinarily called flesh. Organs of this sort have never yet been seen in plants. But not all the movements of the animal body are accomplished by the muscles, and some forms of motion occur in exactly the same way in the plant as in the animal organism.

These movements are most evident, and are most easily explained in the sensitive plant (*Mimosa pudica*). The stem and branches of the sensitive plant bear leaf-stalks, each of which again bears secondary leaf-stalks, to which latter the individual leaflets are attached. If the plant is shaken, the leaf-stalks suddenly bend and sink, the upper surfaces of the two halves of each leaflet

meeting together as do the two halves of a sheet of paper when folded. This movement may be excited in any individual stalk, most easily by touching or softly rubbing the under surface of that part of it which is immediately attached to the branch. At this point the leaf-stalk is attached to the branch by a lump-like thickening or node. Similar nodes occur at the bases both of the secondary leaf-stalks and of the leaflets. If one of these nodes is cut through, a bundle of fibres is observable in the centre, round which there is a layer of cells, very full of sap, the walls of which are thicker on the upper, thinner on the lower side. Between the cells are spaces filled with air. Now, it can be shown that the bending movement is due to the fact that part of the fluid matter passes out of the cells into the intermediate spaces, so that the cellular tissue becomes weaker and less able to support the stalk.

Motion of this sort is, however, very different from the motion peculiar to animals, in that in the latter, as we shall presently see, it serves to counteract the pressure of opposed weights; while in the *Mimosa* the pressure of the leaf-stalk is downward when the under side of the node becomes slack. Before, however, we examine minutely the motion peculiar to animals, mention must be made of certain other phenomena of motion which occur partly in the vegetable, partly in the animal world, but which can scarcely be observed without the aid of the microscope, as the efficient forces in these cases are too slight to produce perceptible movements of the larger parts of the mass.

3. Among these forms of motion we do not include the so-called *molecular*, or *Brownian movements*, to which the celebrated English botanist Brown first called



attention. If portions of vegetable or animal bodies are observed under high magnifying powers, small granules or similar bodies are seen to be engaged in a peculiar tremulous motion. Whence does this arise? That it is not a vital phenomenon is sufficiently shown by the fact that perfectly inanimate bodies, for instance, the carbon particles of finely rubbed Indian ink, exhibit the same movement. The effect is, in fact, due merely to currents in the fluid, by which the light particles suspended in the fluid are carried away. Such currents are easily engendered in any fluid, sometimes in consequence of uneven temperature, sometimes in consequence of evaporation, sometimes, also, as the result of the unavoidable shaking of the microscope. Weak as these currents may be, the disturbance caused by them, when seen under strong microscopic power, seems considerable, and is often hardly distinguishable from those movements which are caused by the vital activities of the particles. Sometimes this molecular motion may be detected within parts of living bodies; in which case small granules swim about in a clear fluid within larger or smaller cavities in these parts of living bodies.

4. If a drop of pond water is placed under the microscope, many living objects, some of which shoot quickly about in all directions, are usually discernible in the water. Side by side with these occur certain oblong, or rod-shaped bodies, moving tremulously about with greater or less rapidity. It is often hard to distinguish whether the motion seen in these latter is independent or molecular. It must be observed whether of these bodies two contiguous individuals always pass along in the same direction, or whether their movements appear independent of each other. In the latter

case it is impossible to suppose that they are only hurried along by currents, and it is safe to conclude that even these simplest organisms are gifted with the power of independent motion. Of the nature of this power nothing is very certainly known. The organisms of which we are speaking belong to the lowest rank of the organic world. They are living beings, for they move, they grow, and they multiply; they can be killed, for instance, by boiling water, and their independent motion then ceases. This is nearly all that is known of them. Next to them rank organisms which are somewhat more complex in structure. They are small lumps of semi-fluid, granular matter, which is called *protoplasm*.<sup>1</sup> This semi-fluid condition—intermediate between a liquid and a solid state—is characteristic of all organic matter. It is due to the absorption of water into the pores of a solid mass, which in consequence swells and undergoes an intimate mixture with the water, and in which the molecules can then change their positions in the same way, though perhaps not quite so easily, as otherwise is possible only in liquids. A thin jelly-like clay would afford the best representation of this condition of aggregation of protoplasm. A small lump of protoplasm of this sort may in itself represent an independent living being, exhibiting vital phenomena of such a kind that it is impossible to refuse to call it an ‘animal.’ It moves by its own force, and, as it would seem, voluntarily; it imbibes matter for its own nutrition from the surrounding liquid; it grows, it multiplies its kind, and it dies. The most evident mo-

<sup>1</sup> Sometimes, but not always, in addition to these fine granules, a larger, bladder-like body, called the kernel or nucleus, is seen within the mass.

tion in this case occurs in two ways. Sometimes single processes are seen to protrude from the whole mass; these processes gradually affect the whole granular mass, so that the whole body is displaced, and a genuine change of position happens to the animal; or the processes being again retracted, other similar processes are protruded from another part of the body, in such a way that the direction of motion is changed; in short, the animal creeps about on the glass plate on which it is observed by means of these processes. Meanwhile currents of granules can be seen within the mass; closer observation, however, shows that the motion in this case is only passive, and that it is the result of a continuous wave-like displacement of the protoplasm.

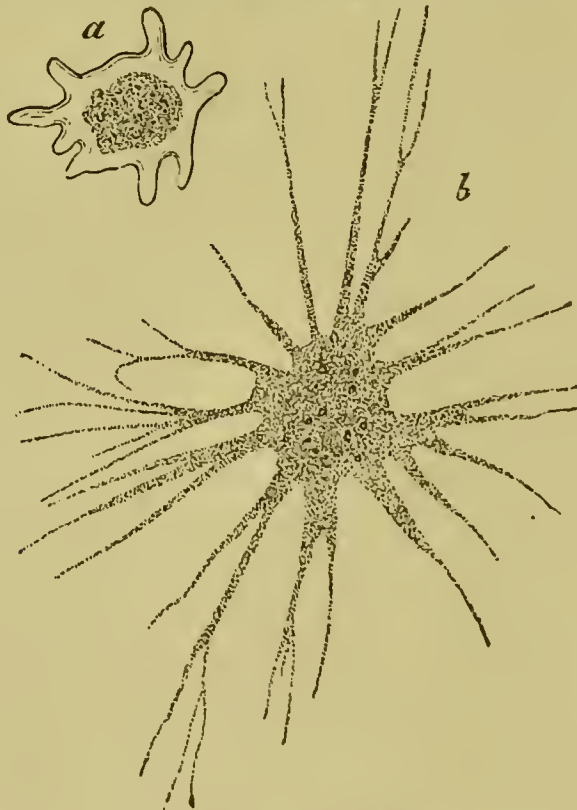

FIG. 1. AMŒBÆ.

*a.* Amœba verrucosa. *b.* Amœba porrecta.

5. Movements entirely similar to those in these independent living animals, called *Amœbæ*, occur in



more highly organised beings, vegetable as well as animal. All living beings are fundamentally composed of just such lumps of protoplasm as we see in the *Amœbæ*. Most of these lumps of protoplasm have, however, essentially changed their appearance, and, at the same time, their qualities, so that it is only from the evolution of the parts that we know them to have originated from such lumps. Moreover, even in developed organisms separate parts always occur which are in all respects similar to such lumps of protoplasm as the *Amœbæ*, and which move like the latter. It is a well-known fact, that when a drop of blood is placed under

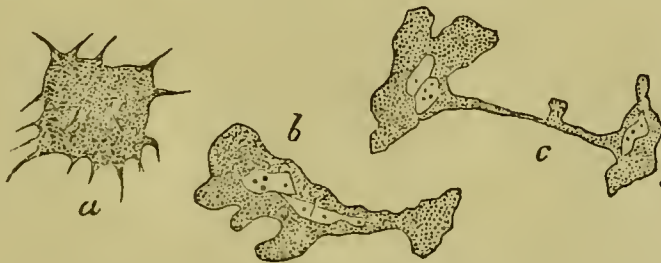

FIG. 2. WHITE BLOOD-CORPUSCLES FROM A GUINEA-PIG.

*a, b, c.* Various forms assumed by one and the same corpuscle.

the microscope, a very large number of small red bodies, to which the red colour of the blood is due, are seen within it. And scattered about among these red blood-corpuscles are seen colourless or white blood-corpuscles, round or jagged in form, and containing granular protoplasm with a kernel or nucleus. If the blood has been placed on a warmed glass, and if it is observed at a temperature of from 35 to 40 degrees C., these blood-corpuscles exhibit active movements entirely similar to those of the *Amœbæ*, and which have, therefore, been called *Amœboid movements*. The corpuscles send out processes and again retract them; they creep about on the glass; and, in short, they behave exactly

like *Amœbæ*, and like the latter they even absorb matter, such as granules of any colouring substance which may have been added, from the blood-fluid—they eat, that is—and after a time they again reject this matter. Moreover, the other form of motion described above, the protoplasmic movements or granule currents, may also be seen in parts of compound organisms. If the tiny hairs of the stinging nettle are placed under the microscope, it appears that each hair consists of a closed sac or pouch, over the inner surface of which protoplasm is spread in a thin layer. Even this represents a much more advanced modification of the protoplasmic mass, but yet the protoplasm still retains its power of independent motion. Wave-like movements are seen to pass over the mass of the protoplasm, and by this, just as in the *Amœbæ*, a current is apparently produced among the granules. For a time the movement continues in one direction; then it suddenly ceases and begins again in an opposite direction; sometimes one current separates itself into two, others unite, and so on. If the protoplasm dies—and this may be artificially caused by the application of heat—all motion ceases. It is inseparably bound up with the vital powers of the cells.

6. The free protoplasmic mass, as seen in the *Amœba*, is one of the simplest of organic forms. Such masses sometimes occur in groups, which thus represent colonies of organisms, each of the components of which, however, retains complete independence, and is exactly like every other. Sometimes, however, modification takes place amongst these; and when these modifications advance at an unequal rate in the separate members of the colony, a composite or-



ganism with variously formed parts is the result. Each part is originally a completely independent organism of equal value with all the others, and each has, therefore, been very aptly called an *elementary organism*. But together with the modification in the form, a change usually takes place in the qualities. Of the various qualities possessed by the protoplasm in its original form, some are lost, others are especially developed. A colony of uniform elementary organisms may be likened to a society in the lowest stage of civilisation, in which each member still personally performs all the tasks necessary to life ; but a composite organism, with variously developed and modified elementary organisms, may be likened to a modern state of which the various members perform very different tasks. The more highly developed plants and animals are of this sort. They originate from a number of elementary organisms—or cells, as they are also called—originally uniform ; but these develop in very different ways—differentiate, as is technically said, and then acquire very different appearance and purpose. In some the power of causing motion, which is originally common to all protoplasm, is especially developed ; others effect sensation, which power was possibly or probably present even in the simple protoplasm. These will be fully discussed in the following chapters. But before doing this, a few words must be said as to one form of these modified cells, in which the power of generating motion is already developed in a very noticeable degree, and serves partly for the independent movement of the cell-body, or of the animal of which the cell is a part ; partly, when occurring in fixed bodies, to move foreign matter—that is, for the drawing in of food.

7. If a light powder—such, for instance, as finely powdered charcoal—is spread over the skin of the palate of a living or a recently killed frog, the powder is seen to advance with some speed towards the gullet. Microscopic examination shows that this skin is studded with a dense layer of cylindrical cells standing, palisade-like, side by side. The free surface of each of these cells is studded with a large number of delicate hairs

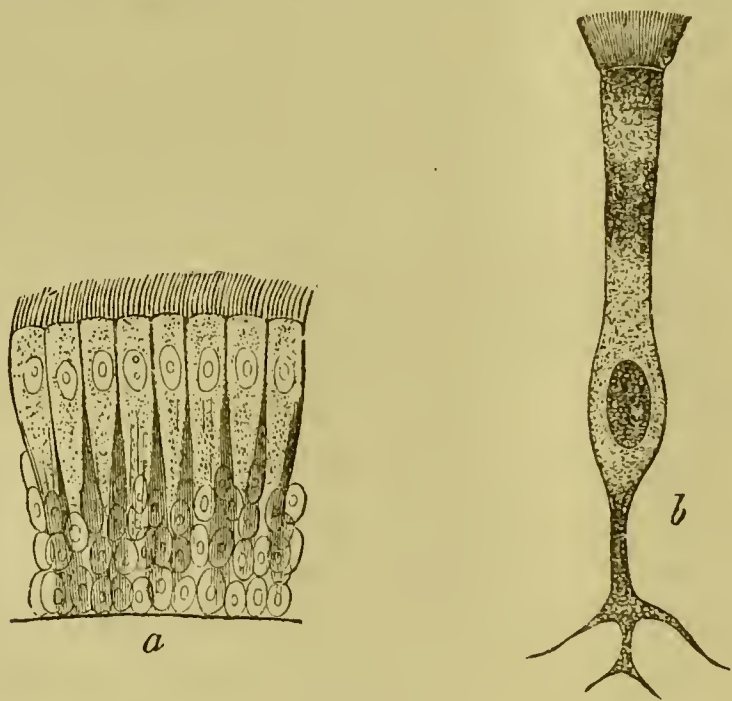

FIG. 3.

*a.* Ciliated cells, pointed below, and, with other cells, attached to the membrane.

*b.* A single ciliated cell, more enlarged and of somewhat more modified form.

or ciliæ, which are in continual motion in a definite direction in such a way that they propel all such liquid, together with the particles contained in this, as adheres to their upper surface in that direction. This is called ciliary motion. It occurs very frequently in the animal body, e.g. in the windpipe and its branches, where the motion is upward, serving to propel the phlegm to the larynx, from which it can be thrown out by coughing.

in many fixed animals of low order a crown of ciliæ encircles the mouth-opening, producing a current which brings water, together with particles floating in the latter, to the animal as food. Other aquatic animals have the whole or a part of their upper surface studded with ciliæ, by means of which they rotate in the water. Finally, there are bodies which, instead of the delicate ciliate hairs, possess only a larger and stronger whip-like process by the sinuous motions of which these animals move themselves about in the water, as a boat may be moved by the quick motion of the rudder, or as a water-newt propels itself by the sinuous motion of its tail.

None of these motions are, however, equal in force and effectiveness to those which are produced by muscles. In higher animals, muscles occur in two forms,—either as smooth muscle-fibres, or as striated muscle-fibres. The former are spindle-shaped cells which have grown out in a longitudinal direction, and which have rod-shaped kernels (*nuclei*) and pointed ends, sometimes twisted like a corkscrew. The latter are produced by the coalescence and amalgamation of several cells, the contents of which have undergone an important change. These, and the qualities of these, will be fully discussed in the following chapters.

## CHAPTER II.

1. Muscles, their form and structure; 2. Minute structure of striated muscle-fibres; 3. Connection of muscles and bones; 4. Bones and bone-sockets; 5. The law of elasticity; 6. Elasticity of the muscles.

1. Muscles are elastic structures capable of altering their form—that is, of becoming shorter and thicker. In the bodies of the more highly developed animals they constitute those masses which are commonly called flesh. The flesh, when carefully studied, is found to consist of bundles of fibres, the ends of which are produced into white cords, most of which are attached to bones. When one of these muscles shortens, it exerts a strain, by means of these white cords, on the bones; and these latter, being movable the one against the other, are thus put in motion by the shortening of the muscle. All muscles are not, however, arranged in this way; some ring-shaped muscles form the walls of sacs or pouches, and these, by contracting, decrease the space within these cavities, so that the contents of the latter are thus forced onward. In any case, muscles always serve to produce movement—either of the limbs in opposition to each other, or of the whole animal, or of the substances contained within the cavities.

We must first confine our attention to those muscles which are attached to bones, and which are therefore



called skeleton muscles. These muscles occur in various forms. Sometimes they are flat, thin bands, and sometimes cylindrical cords, some of which are of considerable length. Others again are thicker in the middle than at the ends; in these cases the middle is called the trunk, the ends are spoken of as the head and tail, of the muscle. Some muscles have two or more heads—that is, two or more ends—springing from different points on the bone,

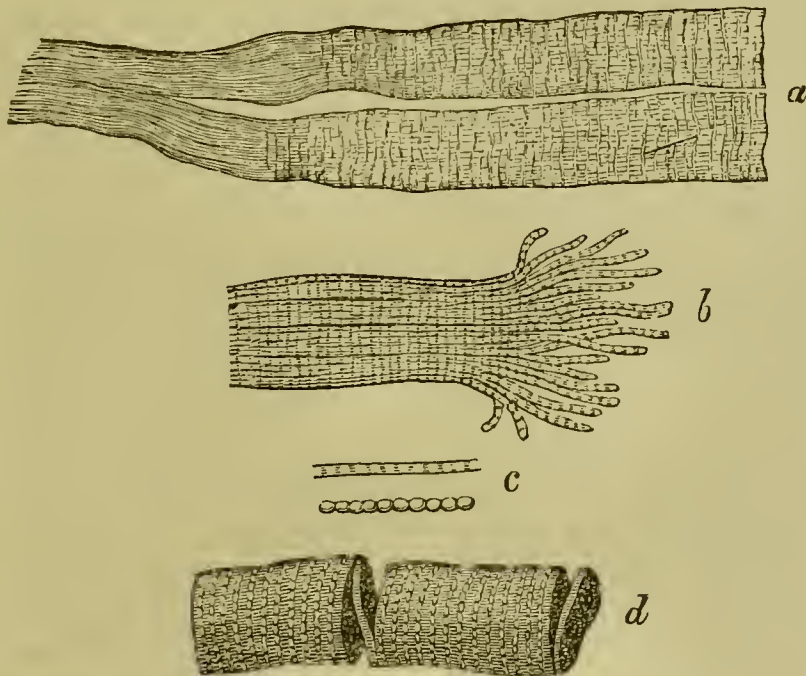

FIG. 4. STRIATED MUSCLE-FIBRES.

*a.* Two fibres cut through in the middle, and passing, on the left, into tendons. *b.* A single muscle-fibre deprived of its discs, and separating into fibrillæ. *c.* Two single fibrillæ. *d.* A muscle-fibre separating into its discs.

and uniting in a common trunk. But these muscles, whatever their external shape, always consist of several fibres, united into a bundle, and together forming the muscle as a whole. One of these fibres, when isolated, will be found to be very minute, and scarcely visible to the naked eye; when seen, enlarged from 250 to 300 times, under the microscope, it appears as a pouch, consisting of a firm, solid wall, with certain contents; and this contained matter exhibits alternate lighter and

darker streaks, placed at right angles to the longitudinal direction of the fibres. For this reason, these muscle-fibres are called *streaked* or *striated* muscles, in order to distinguish them from certain others of which we shall presently learn. In order to obtain an approximate idea of the appearance of one of these fibres, we may imagine it as a roll of coins, the separate pieces of which are, however, transparent and alternately lighter and darker. Some observers have indeed assumed that a muscle-fibre really consists of discs of this sort, ranged side by side. The fibres, when treated with certain chemical re-agents, separate into these discs, and while some of them yet remain attached to each other, the fibre very closely resembles a roll of coins: the pieces of which are falling away from each other. But there are other re-agents which split up the fibre in a longitudinal direction, so that it separates into extremely delicate smaller *fibres* or *fibrillæ* each of which still exhibits the alternation of lighter and darker parts, which, in the entire fibre, produce the transverse striation. Moreover it can be shown that a muscle-fibre when recently taken from the living animal must, in reality, be of a fluid, or, at least, of a semi-fluid nature. So that it is impossible to affirm that either the discoid or the fibrilloid structure actually exist in the muscle-fibre itself; it must rather be assumed that both forms of structure are really the result of the application of re-agents which solidify the originally fluid mass and split it up in a longitudinal or transverse direction.

2. It is hard to say what the true character of the fresh, or, as we may also call it, the living muscle-fibre really is. Recent observations by means of very much improved and very highly-magnifying microscopes, have

brought to light other differences besides that of the mere alternation of lighter and darker streaks. Of the highest importance as explaining the structure of muscle-fibres are the researches of E. von Brücke into the phenomena exhibited by muscle-fibres in polarised light. According to modern physical views, light depends on the vibrations of ether, an impalpable matter spread throughout the universe and present in all bodies. These vibrations always proceed at right angles to the direction in which motion is propagated. Within this imaginary plane at right angles to the ray of light, an ether particle may vibrate in the most diverse directions. Under certain circumstances, however, they all vibrate in one and the same plane, in which case the ray exhibits certain peculiarities, and is said to be polarised.<sup>1</sup> Certain crystals have the power of polarising such rays of light as pass through them. A few, at the same time, separate each ray of light into two rays which move separately from the original ray. Such crystals are called double-refracting bodies. Iceland spar or, as it is also called, double spar, is the best-known example of such a double-refracting body. Brücke has shown that of the two substances which form the alternate layers of striated muscle, the one transmits light unchanged, the other is possessed of double-refracting powers. But, as has already been said, the contents of a living muscle-fibre must be regarded not as solid but rather as fluid, or at least as semi-fluid; and observations made on living muscle-fibres show that the streaks are not incapable of modification in their breadth and in their distance from

<sup>1</sup> This circumstance is treated in more detail in Lommel's *The Nature of Light* (International Scientific Series, Vol. XVII.)



each other. Brücke, therefore, supposes that the muscle substance is in itself homogeneous or uniform, but that in it are inserted small particles which are of double-refracting power. When these particles are massed in large numbers, and are regularly arranged, they refract the light doubly, so that the whole of that particular part seems to refract doubly, while the intermediate parts, since they contain few or none of the particles in question, continue to refract simply. These latter parts, however, when seen under ordinary unpolarised light, so that it is impossible to judge of their powers of double refraction, appear lighter, while the former appear darker; and so together they cause the striated appearance of the muscle.

3. In one of these muscle-fibres it is necessary to distinguish the contained matter and the containing pouch. The latter is called the muscle-fibre pouch, or *sarcolemma*. In it, especially after the addition of acetic acid, which causes the whole fibre to swell and become more transparent, a number of longish pointed kernels (*nuclei*) are seen, and similar kernels occur also in parts within the muscle-fibre. To the ends of the muscle-fibre, which are rounded and are very uniformly enclosed by the pouch, which must therefore be regarded as a long closed sac, the white cords mentioned above attach themselves, and these are completely coalescent with the sarcolemma.

They consist of strong slender threads of the nature of the so-called connective tissue. As a considerable number of muscle-fibres constitute the trunk of the muscle, these threads also unite into cords which are called the muscle-tendons. They are sometimes short, sometimes long, thicker or thinner according to the



size of the muscle, and they serve to attach the muscles firmly to the bones, to which, acting like ropes, they transmit the tension of the muscles. One of the two bones to which a muscle is attached is usually less mobile than the other, so that when the muscle shortens, the latter is drawn down against the former. In such a case the point of attachment of the muscle to the less mobile bone is called its origin, while the point to which it is fixed on the more mobile bone is called its attachment (*epiphysis*). For instance, there is a muscle which, originating from the shoulder-blade and collar-bone, is attached to the upper arm-bone; when this muscle is shortened, the arm is raised from its perpendicular pendant position into a horizontal position. A muscle is not always extended between two contiguous bones. Occasionally passing over one bone, it attaches itself to the next. This is the case with several muscles which, originating from the pelvic bone, pass across the upper thigh-bone, and attach themselves to the lower thigh-bone. In such cases the muscle is capable of two different movements: it can either

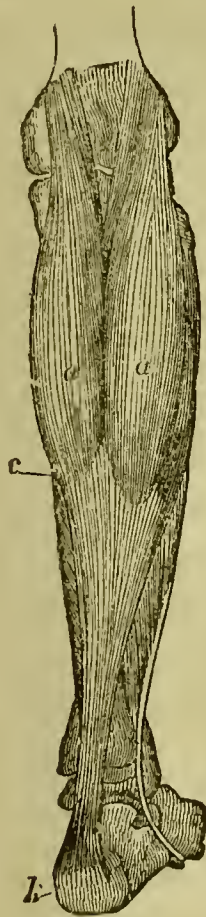

FIG. 5. THE DOUBLE-HEADED CALF-MUSCLE (*M. gastrocnemius*), WITH ITS TWO TENDONS.

*a, a.* The two heads. *c.* The commencement of the tendon which at *k* is attached to the heel-bone.

stretch the knee, previously bent, so that the upper and the lower thigh-bones are in a straight line ; or it can raise the whole extended leg yet higher and bring it nearer to the pelvis. But the points of origin and of attachment of muscles may exchange offices. When both legs stand firmly on the ground, the above-mentioned muscles are unable to raise the thigh ; instead, on shortening, they draw down the pelvis, which now presents the more mobile point, and thus bend forward the whole upper part of the body. In order, therefore, to understand the action of the skeleton, the separate bones of the skeleton and their connection must first be studied.

4. All bones are classified according as they are flat, short, or long. Flat bones, as their name indicates, are expanded chiefly in two directions ; they form thin plates. Short bones are expanded almost equally and but slightly in all three directions. In long bones, finally, the expansion in the longitudinal direction considerably exceeds that in the other two directions. The extremities, the arms and legs, are chiefly formed of these long bones. The arm, for instance, consists of the long bone of the upper arm, to which are attached, first, two other long bones (called the elbow bone and the radius), which together form the fore-arm ; and secondly, by means of several shorter bones, which constitute the wrist, the hand itself ; this latter consists of the five bones of the palm and the five fingers, of which the first has two, the others each have three divisions. In all these bones, with the exception of those of the wrist, a long middle part, or shaft, with two thickened ends, are noticeable. As this shaft is hollow, these bones are also spoken of as cylindrical. The expanded

ends are rounded and are provided with a smooth cartilaginous covering. The smooth ends of two contiguous bones fit into each other, so that when the surfaces of the two ends glide the one over the other, the two bones are capable of motion in opposite directions. The point of attachment between two bones is called the socket; and the surfaces of the two ends of the bones where they touch each other are called the socket surfaces. The motion which these bones have the power of exercising in opposite directions varies with the form of these socket surfaces. When the surface of the socket is of semi-spherical form, the motion is most free, and can be exerted backward or forward in any direction. The socket in this case is called a ball- or nut-socket. An example of this sort may be seen at the upper end of the bone of the upper arm, where it ends in a ball-shaped surface which is applied to a corresponding socket surface in the shoulder blade. In other

cases motion can only take place in a definite direction, as, for instance, in the case of the socket connecting the upper and fore arms. These are called hinge-sockets. They serve to increase or decrease the

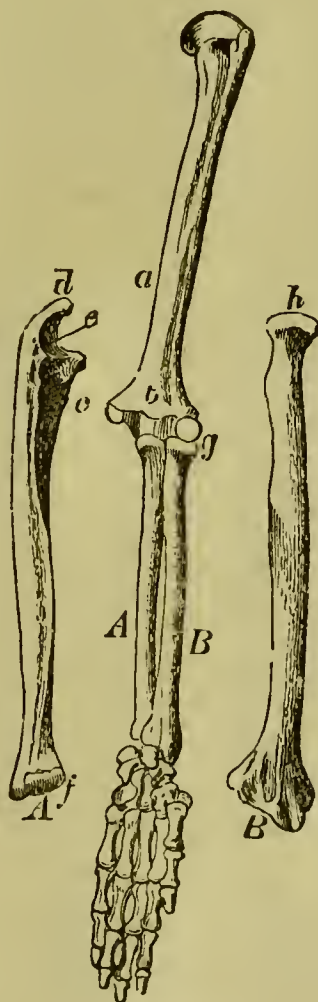

FIG. 6. THE BONES OF THE ARM.

*a.* Bones of the upper-arm. *A.* Elbow bone. *B.* Radius. *b g.* The connection of the bones at the socket of the elbow.



angle between the two parts. To mention all the various forms of sockets and the movements which they allow would lead us too far; it is sufficient to have shown that the action of the muscles is affected by the bones between which they are extended. In order, however, to examine the contractile power of muscles, the latter may be detached from the bones and examined by themselves.

The muscles of warm-blooded animals are but ill-adapted for this purpose; fortunately, however, those of cold-blooded animals not only possess the same qualities, but retain the power of contraction long after their removal from the animal, a circumstance which renders them very valuable for purposes of study. The frog is most frequently used in such experiments, both on account of its common occurrence and of the power of its muscles. If a frog is beheaded and an entire muscle is cut from either its upper or lower thigh, one of the tendons of this muscle may be fixed in a vice, and its other tendon may be connected with a lever, representing as it were the bone, by the motion of which the contraction of the muscle may be studied.<sup>1</sup> Weights may also be attached to this lever in such a way that the burden which the muscle is capable of lifting may be studied. It will at once be observed that the muscle is extended when such weights are attached, and is extended more in proportion as the weight attached is heavier. This results from the elastic qualities of muscle; and before examining the contraction of muscles it will be necessary carefully to study their elasticity.

<sup>1</sup> In order to fasten the muscle more securely, it is generally well to leave a small piece of the bone at either end attached to the tendons, and to fasten the muscle by these.

5. Those bodies which alter their form under the influence of external forces, and resume their original form on the cessation of these external forces, are called *elastic*. The greater these alterations are, the greater is the elasticity of the body. The external force producing the alterations may be either tension, extending the body in one particular direction; or it may be pressure, compressing the body into a smaller space; or, again, it may be tension combined with pressure, bending the body. We are only concerned with the force of tension, which acting on the body in a longitudinal direction extends it; that is to say, we are about to study the elasticity of muscle tension. Physicists have experimented on elastic tension in bodies of the most diverse kinds. But bodies of regular shape, rods or threads, the length of which considerably exceeds the thickness, are best adapted for such experiments.

On firmly fastening a body of this kind, for instance a steel wire or a glass thread, to a beam in the ceiling, and, after accurately measuring its length, attaching weights to the lower end, it will be found that the extension caused by these weights is greater in the first place in proportion as the weights causing the extension are greater, and in the second place in proportion as the body which is extended is longer. And, on the contrary, with any given weight and length, the extension will be found to be less in proportion as the body is thicker, or, in other words, the larger is its cross-section. This latter circumstance may be easily understood by assuming that the rod or thread consists of a number of smaller rodlets or tiny threads which lie evenly side by side. If, for instance, we select for this experiment a steel rod, the cross-section of which measures exactly



one square centimetre, we may assume that this consists of a hundred rodlets of equal length, lying side by side, the cross-section of each of which measures exactly one square millimetre. On attaching a weight of one kilogramme (= 1000 gr.) to this rod, each one of the hundred thin rodlets would have to bear a weight of but ten grammes. Comparing with this the tension of another steel rod of the same length, but of which the cross-section measures twice as much, we may assume that this second rod is composed of two hundred minute rodlets, the cross-section of each of which measures one millimetre. The weight being now distributed between two hundred of these rodlets, each has to support a weight of only five grammes. This explains why the tension by the same weight is only half as great in a rod of double thickness. That the extension is proportionate to the length of the extended rod can be explained in the following way. According to the views of modern physicists every body consists of a number of small molecules or particles which are held at definite distances from each other by attractive and repulsive forces. On fastening a rod by its upper end and attaching a weight to its lower end, the molecules are by these means slightly separated from each other. The sum of all these small separations represents that whole extension measurable at the end. The longer any given body is, the greater is the number of these small particles which occur in its whole length, and consequently the greater must its extension be, provided all other circumstances are equal.

From these observations may be deduced a law as to elastic tension, which is further confirmed by accurate researches, and this law is that *the tension is directly*

*proportionate to the length of the body extended, and to the amount of the extending weights; and that it is also proportionate in inverse ratio to the diameter of the extended body.* This is called the law of elasticity, of Hook and S'Gravesande. In order, however, to find the tension of a particular body, another factor connected with the nature of the body itself must be known; for, under otherwise equal conditions, the tension, for instance, of steel, as found by actual experiment, differs from that of glass, and that of the latter from that of lead, and so on. In order, therefore, to be able to calculate the tension in the case of all bodies, the tension, experimentally found, must be reduced to the units of length and diameter of the weighted bodies, and to units of the weight applied. This gives a figure which expresses the tension of a body of a given nature of one millimetre in length, and with a cross-section measuring one square centimetre when supporting a weight of one kilogramme. This result, which is constant in the case of every substance, whether it be steel, glass, or aught else, is the *co-efficient of elasticity* of that substance.

6. Similar researches have been made in the case of organic bodies also, such as caoutchouc, silk, muscle, &c., and in so doing certain peculiarities have been observed which are of course of great importance to us. In the first place, all these bodies—which we may also call *soft*, to distinguish them from those *rigid* bodies of which, up to the present, we have been speaking—exhibit a much greater extensibility. That is to say, soft, organic bodies are capable of far greater extension than are rigid, inorganic bodies of equal length and diameter, and under the application of equal weight. But the

former also exhibit another peculiarity. If a weight is attached to a steel wire, or some other similar body, the latter extends, and retains its new length so long as the weight acts upon it; but as soon as the weight is removed the steel resumes its original length. It is not so in the case of inorganic bodies. For instance, if a weight is attached to a caoutchouc thread it will be found that the latter is immediately extended to a certain length; but if the weight is not removed, it will be found that the caoutchouc thread extends yet more, and the weight continues to sink, though, indeed, but slowly, and, as time goes on, with ever decreasing speed. But even at the end of twenty-four hours a slight additional extension of the thread is observable. If the weight is then removed, the thread immediately becomes considerably shorter, but does not entirely revert to its original length; it attains the latter very gradually and in the course of many hours. This phenomenon is known as the *gradual extension of organic bodies*. It takes place in very considerable degree in muscle, and naturally increases the difficulty of determining the extensibility of muscles, in that the measurements differ according to the moment at which they are read. It is safest to take into consideration only that extension which occurs instantaneously, without regard to that which gradually follows.

Various apparatus have been produced for examination of muscular extension. The latter can be most accurately read by means of the apparatus invented by du Bois-Reymond, represented in fig. 7. The muscle is firmly fastened to a fixed bearer, its upper tendon being fixed in a vice. A small, finely graduated rod is fastened to the lower tendon by means of a small hook.



Below the graduations the rod branches into two arms, which again re-unite at a lower point, and within the space thus formed a scale-plate is fixed for the reception of the weights which it is desired to apply. Finally the rod ends in two vertical plates of thin talc standing at right angles to each other, and these are immersed in a vessel filled with oil, so that, while offering no obstacle to the upward and downward motion of the apparatus, they prevent any lateral movement. In order to determine the extension of the muscle, the graduated rod attached to it must be observed through a lens, and it must be noted which divisional line of the graduated rod corresponds with a thread stretched horizontally across the lens; weights must then be applied, and the increase in length, which declares itself by an alteration in the relative position of the graduated rod and the thread, must be observed. Of course, in calculating the extensibility from the figures thus obtained, the weight of the apparatus attached to the muscle must be taken into consideration.



FIG. 7. DU BOIS-REYMOND'S APPARATUS FOR THE STUDY OF ELASTIC EXTENSION IN MUSCLE.

Experiments in muscular elasticity may also be made with the apparatus briefly described above, by measuring the extensions of the muscle by the variations of a lever attached to it. The easiest way to do this is by fastening an indicating apparatus to the lever in such a way

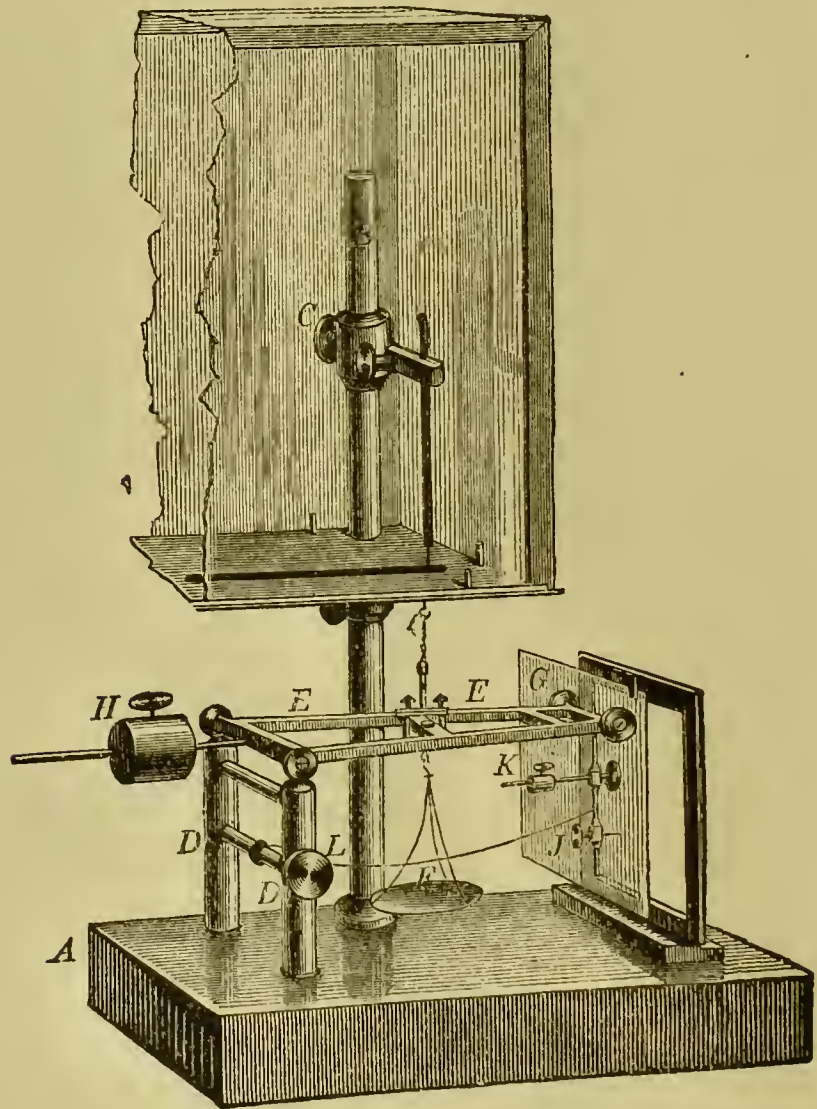

FIG. 8. SIMPLE MYOGRAPH.

that it traces the movements of the lever on a plate of smoked glass placed in front of it. This apparatus is called a *myograph*, or muscle-writer. Fig. 8 represents it in the simplified form adopted by Pflüger. The body, the elasticity of which is to be examined, is firmly fixed



in the vice *C*, and is connected with the lever *E E*, the point of which touches the plate of smoked glass. The weight of the lever is held in equipoise by the balance *H*. When weights are placed in the scale-pan at *F*, the lever moves upward, and its point marks a straight line which affords opportunity for measuring the amount of the extension.

But in whatever way examined, muscle, in common with all other soft bodies, exhibits another variation from the bearing of rigid bodies. We have seen that in steel or similar bodies the extension is exactly proportionate to the weight applied; that is to say, if a given steel wire is extended one millimetre by one kilogramme, then the amount of extension caused by two kilogrammes is two millimetres, that by three kilogrammes is three millimetres, and so on. It is not so in the case of muscle and other soft bodies. They are comparatively more extensible by light than by heavy bodies. For instance, if the extension of a muscle when carrying ten grammes is five millimetres, when carrying a weight of twenty grammes it is, not ten millimetres, but perhaps only eight; when carrying thirty grammes it is only ten millimetres, and so on. The extension, therefore, becomes continually less as the weight increases, and finally becomes unnoticeable by the time that the point at which the muscle is torn by the applied weights is reached. This behaviour is of importance, because the conditions of elasticity play an important part in muscular operations. The muscle on contracting is capable of lifting a weight. The same weight, however, extends the muscle, and the co-operation of the two forces—the contractile tendency and the elastic extension—produces, as we shall find, the final operation on which labour depends.

## CHAPTER III.

1. Irritability of muscle; 2. Contraction and tetanus; 3. Height of elevation and performance of work; 4. Internal work during tetanus; 5. Generation of heat and muscle-tone; 6. Alteration in form during contraction.

1. If a muscle is cut from the body of a frog, and is fastened into the myograph just described, it never shortens spontaneously. If this does seem to happen, it may safely be assumed that some accidental and unperceived external cause has influenced it. A muscle may, however, always be induced to shorten by pinching it with tweezers, by smearing it with strong acid, or by bringing certain other external influences, the nature of which we shall presently learn, to bear upon it. Muscle, therefore, never shortens spontaneously, but it can always be induced to do so. This quality of muscle enables us to produce the state of contraction at pleasure, and to examine accurately the nature and method of the conditions which give rise to it and the phenomena by which it is accompanied.

The myograph which, by means of the indicator attached to it, marks the contraction of the muscle on the smoked glass plate, and at the same time affords opportunity for measuring the extent of the contraction, will presently prove of yet greater service. But for

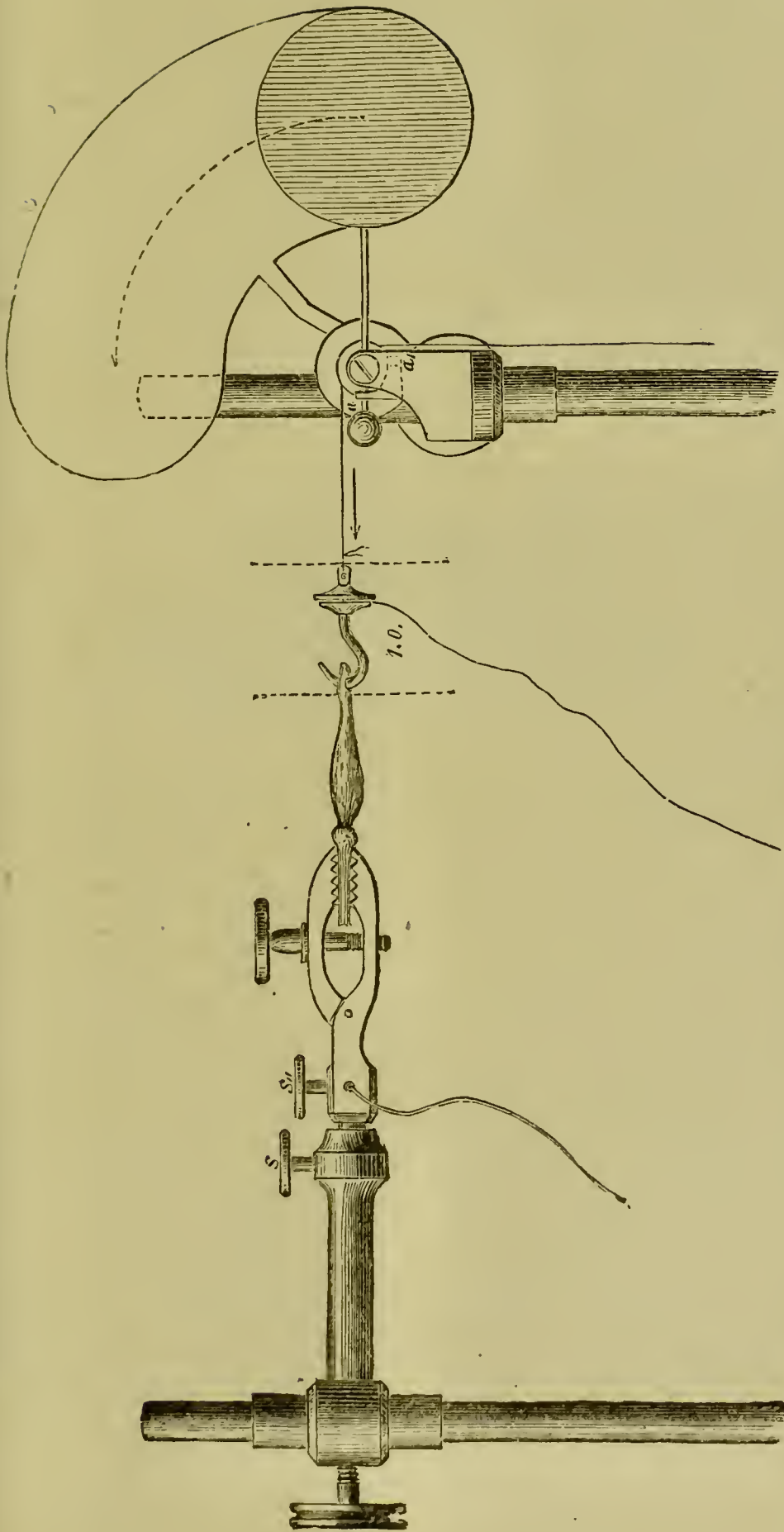

FIG. 9. THE MUSCLE-TELEGRAPH AS USED BY E. DU BOIS-REYMOND.

our present purpose—which is to discover whether or not contraction takes place under certain circumstances—it is hardly adapted. It may, therefore, be replaced by another apparatus, arranged by du Bois-Reymond especially for experiments during lectures, and called by him the *muscle-telegraph*. The muscle is fixed in a vice; its other end is connected by a hook with a thread running over a reel. The reel supports a long indicating hand to which a coloured disc is attached. The muscle in shortening turns the wheel and lifts the disc; and this is easily seen even from a considerable distance. A second thread, slung over the reel, supports a brass vessel which may be filled with shot, so as to apply any desired weight to the muscle.

The influences which cause the contraction of the muscle, such as pinching or smearing with acid, are called *irritants*, and the muscle is said to be *irritable*, because contraction can be induced in it by these means. The irritants already spoken of are mechanical and chemical; they labour under a disadvantage in that the muscle, at least at the point touched, is destroyed, or at least is so changed that it is no longer irritable. There is, however, another form of irritant which is free from this disadvantage. If the vice which holds the upper end of the muscle and the hook to which the lower end is attached are fastened to the two coatings of a charged Kleistian or Leyden jar, the charge acts at the moment at which the connection is formed, and an electric shock traverses the muscle. At the same instant the muscle is seen to contract, and the disc passes abruptly upward. In order to repeat the experiment it would be necessary to re-charge the Kleistian jar. But similar electric shocks may be more con-



veniently produced by means of so-called induction. Let us take two coils of silk-covered copper wire and attach the two ends of one of these to a muscle. An electric current from a battery must now be passed through the other coil *A*. The two coils being completely isolated from each other, the current passing through *A* can in no way enter into *B* or into the muscle attached to *B*. If, however, the electric current in *A* is suddenly interrupted, an electric shock immediately arises in *B*, a so-called *inductive shock*; and this passes through and irritates the muscle; that is to say, a

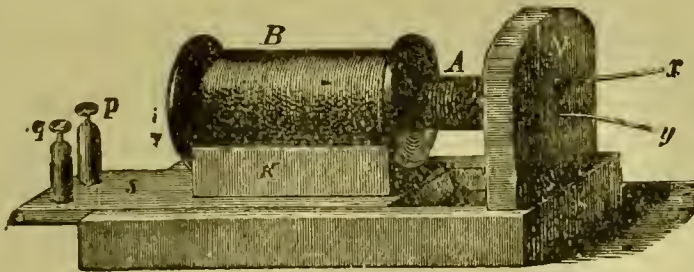

FIG. 10. INDUCTION COIL.

The coil *A* is connected with the battery by means of the wires *x* and *y*; the other coil, *B*, is connected with the muscle by means of wires fixed at *q* and *p*.

sudden contraction of the muscle is observable at the instant of the opening of the current in coil *A*; and this suddenly lifts the disc attached to the muscle. The same thing occurs when the current in the coil *A* is again closed; so that this electric irritant affords an easy and simple means of causing this sudden contraction of the muscle at pleasure. This contraction may be called a *pulsation*; and it will be perceived from the description of the above experiments that a simple electric shock, such as is afforded by the discharge of a Kleistian jar, or any similar inductive shock, is the most convenient means of producing such a pulsation as often as it is required.



An electric current from the battery itself is also capable of acting as an irritant on muscle. If the poles of the battery are connected with the muscle, a constant current passes through it. If one of the connecting wires consists of two parts, a capsule filled with quicksilver may be inserted between the cut ends. One end of the wire must be allowed to remain immersed in the quicksilver; the other end must be bent into the form of a hook so as to allow it to be easily immersed in, and again withdrawn from, the quicksilver. This makes it easy to close the current within the muscle, and to interrupt it again at pleasure. At the moment at which the current is closed, a pulsation is observed entirely similar to that which would be produced by an electric shock. The muscle contracts, and the disc is jerked upward and then falls again. But it does not return quite to its original position; it remains somewhat raised, thus showing that the muscle is now continuously contracted; and this contraction lasts as long as the current passes uninterruptedly through the muscle.

If the current is interrupted, a pulsation which jerks the lever upward is sometimes but not always observable; the muscle then, however, resumes its original length, which it retains until it is irritated anew.

2. These experiments show that muscle exhibits two forms of contraction: the one, which we called pulsation, is of short duration; the other, which is produced by a constant electric current, endures longer. This more enduring form of contraction may, moreover, be yet more conveniently produced by allowing an irritant such as in itself would only produce a single pulsation.

to operate repeatedly in quick succession. An inductive current is most suitable for this purpose, for it can be produced at will by the closing and opening of another current. Once more turning to the coils *A* and *B* (fig. 10, p. 31), let *A* be connected with a chain, *B* with the muscle. Within the circuit of the chain which includes *A*, we can insert an apparatus capable of repeatedly and rapidly shutting or opening the current. For this purpose a so-called electric wheel is used. The wheel *Z* is made of some conducting substance, such as copper, and its circumference is cut into teeth like that of the ratchet-wheel of a watch. The copper wire rests on this circumference. The axis of the wheel and the wire *b* are connected with

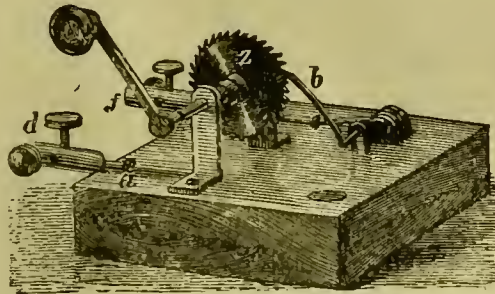

FIG. 11. ELECTRIC WHEEL.

the conducting wires by means of the screws *d* and *f*. When the click rests on one tooth of the circumference of the wheel, the current is enabled to pass through the wheel, and thus also through coil *A*; it is, however, interrupted during the interval which intervenes while the click springs from one tooth to the other. Therefore, by turning the wheel on its axis the current in coil *A* is alternately closed and opened. Consequently, inductive currents constantly occur in the adjacent coil *B*, and these pass in rapid succession through the muscle. Each of these currents irritates the muscle; and since they occur in such quick succession, the muscle has no time to relax in the intervals, but continues permanently contracted. Enduring con-

traction of this sort is called *tetanus* of the muscle to distinguish it from a series of distinct pulsations.

Another method of frequently and repeatedly closing and opening the current is by means of a self-acting apparatus which is put in motion by the current itself. This, which is called Wagner's hammer, is represented in fig. 12. The current of the chain is con-

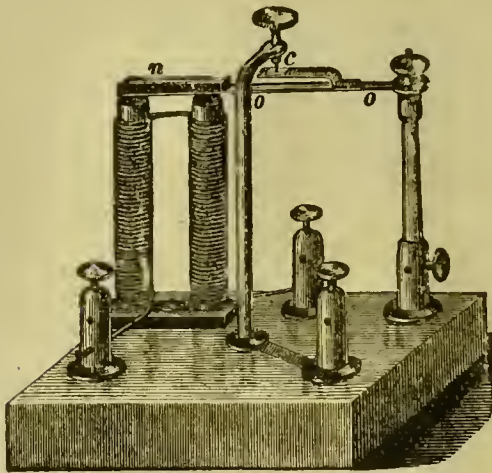

FIG. 12. WAGNER'S HAMMER.

ducted through the column represented on the right to the German silver spring *o o*. A small platinum plate *c* is soldered on to the latter, and is pressed against the point above it by the elastic force of the spring. The current passes from this to the coils of a small electro-magnet, and, after passing through this, back to the chain

through the clamp connected with it on the left. An armature of soft iron, *n*, fastened on to the spring *o o*, is suspended over the poles of the electro-magnet. This iron being attracted by the electro-magnet, the small plate *c* is forced away from the point and the current is thus interrupted. In so doing, however, the electro-magnet parts with its magnetism, and consequently relinquishes its hold upon the armature; the plate is thus again pressed by the action of the spring against the point. The current being thus again closed, the electro-magnet recovers its force, again attracts the armature, and again interrupts the current; and these processes are continued as long as the chain remains inserted between the column on the right and



the clamp on the left. In order to use this hammer for the production of inductive currents, the one coil, *A*, of the apparatus (shown in fig. 10, p. 31), must be inserted between the two clamps shown on the right.<sup>1</sup>

Wagner's hammer in a more simple form may be permanently connected with coil *A*. In this case it is best to place the second coil *B* on a sliding-piece which is so arranged that it can be moved along a groove to a

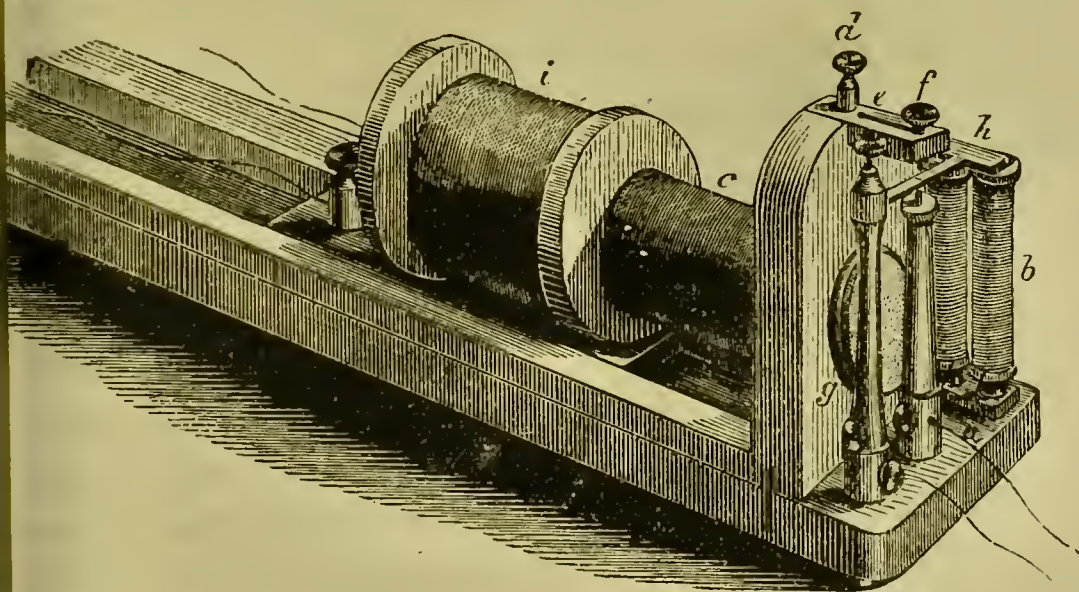

FIG. 13. THE SLIDING INDUCTIVE APPARATUS.  
(As used by du Bois-Reymond.)

greater or less distance from coil *A*. This enables the operator to regulate the strength of the inductive current generated in it. Fig. 13 represents an apparatus of this sort. The secondary coil, in which the inductive currents originate, is in this case indicated by *i*; the primary coil, through which the constant currents pass, by *c*; *b* is the electro-magnet; *h* the armature of the hammer; *f* is a small screw, at the point of contact of which with the

<sup>1</sup> In order to set Wagner's hammer itself in motion, these clamps must be connected by a wire through which alone the connection from the point to the coils of the electro-magnet is made.

small plate soldered on to the surface of the German silver spring the current is closed and interrupted. An apparatus of this kind is called a sliding inductorium. It is only necessary to attach the ends of the coil *i* to the muscle, and to insert the chain between the columns *a* and *g*. The action of the hammer then at once

commences; the inductive currents generated in *c* pass through the muscle, which contracts tetanically.

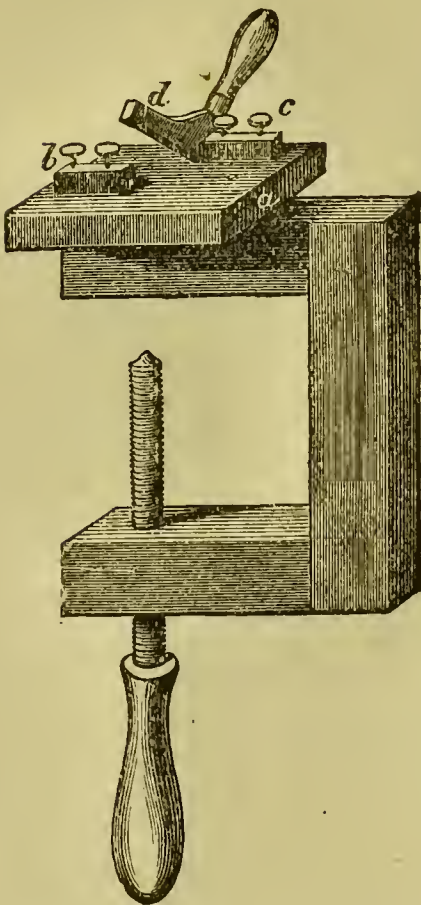

FIG. 14. TETANISING KEY OF  
DU BOIS-REYMOND.

Instead of connecting coil *c* immediately with the muscle, it is better to carry the wires from the coil to the two clamps *b* and *c* in the apparatus shown in fig. 14, which is called a *tetanising key*. Two other wires pass from these same clamps *b* and *c* to the muscle. When the inductive apparatus is in action the muscle is put into a tetanic condition. But as soon as the lever *d* is pressed down, so as to connect *b* and *c* together, the current of coil *i* is enabled to pass through this lever. The lever *d* being made of

a short and thick piece of brass, which offers hardly any resistance to the current, while the muscle on the contrary offers great resistance, very little of the current passes through the muscle, but nearly all through the lever *d*. The muscle, therefore, remains at rest. As soon, however, as the lever *d* is again raised, the inductive currents must again pass through the muscle.



A slight pressure on the handle of the lever  $d$  is, therefore, sufficient to produce or to put an end to the tetanic condition at the will of the operator, thus allowing more accurate study of the muscle processes.

We have now noticed muscle in two conditions: in the ordinary condition in which it usually occurs either within the body or when taken from the body, and in the contracted condition which results from the application of certain irritants. The former condition may be spoken of as the *rest* of the muscle, the latter as the *action* of the muscle. Muscular action occurs in two forms, one of which is a sudden temporary shortening or pulsation, while the other is an enduring contraction or tetanus. The latter, on account of its longer duration, is more easily studied. In many cases it is a matter of indifference whether pulsating or tetanised muscle is examined. In the following investigations we shall therefore employ sometimes one, sometimes the other, method of irritation.

3. On attaching weights to a muscle, the latter is capable of raising these weights so soon as it is set in motion. It raises the weight to a certain height, and thus accomplishes labour which, in accordance with mechanical principles, can be expressed in figures by multiplying together the weight raised and the height to which it is raised. This height to which the weight can be raised, which may be called the height of elevation of the muscle, can be measured by means of the myograph already described. On attaching a weight to the lever of the myograph, the muscle is immediately extended. The pencil must now be brought in contact with the glass plate of the myograph, and the muscle must be made to contract by opening the

key so as to allow the inductive currents to have access to the muscle. The latter at once shortens, and its height of elevation is indicated by a vertical stroke on the smoked glass plate. On instituting a series of experiments with the same muscle but with various weights, it will be found that the muscle is not able to raise all weights to the same height. When the weight is small the height to which it is raised is great. As a rule, as the weight increases, the height to which it is raised becomes less, and finally, when a certain weight is reached, it becomes unnoticeable. Fig. 15

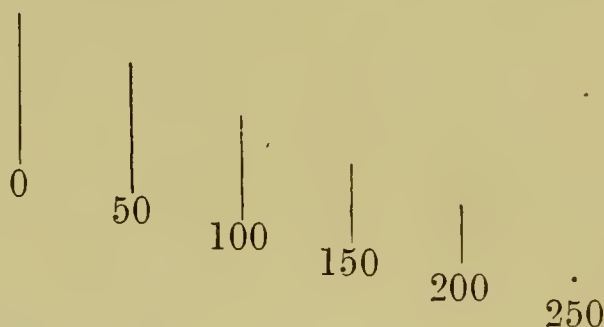

FIG. 15. HEIGHT OF ELEVATION CONSEQUENT ON THE APPLICATION OF VARYING WEIGHTS.

shows the result of a series of experiments of this sort. The figures under each of the vertical strokes represent in grammes the amount of the weight raised; the height of the strokes is double the real height of elevation, the apparatus employed in the experiment representing them twice their natural size. Between each two of the experiments the glass plate was pushed on a little further in order that the separate experiments might be indicated side by side. In finding the first of these heights of elevation, under which stands an 0, no weight was applied, and even the weight of the indicating lever was neutralised by an equivalent weight. It appears, therefore, that the height of elevation is

greatest in this case. Each of the succeeding heights begins from a somewhat lower point in consequence of the extension of the muscle by the applied weights. But each also rises to a less height than that which preceded it; and, finally, a weight of 250 grammes being applied, the height of elevation is naught.

From this series of experiments it is evident that, as the weight increases, the height to which it is raised continually decreases. The following conclusion must, therefore, be drawn as to the work accomplished by the muscle. When no weight is applied, the height of elevation is great; but as no weight is raised in this case, the amount of work accomplished, therefore, also equals 0. When 250 grammes, the greatest weight, is applied, the height of elevation equals 0, so that in this case also no work is accomplished. It was only on the application of the intermediate weights that the muscle accomplished work; and this, moreover, at first increased until a weight of 150 grammes was reached, and then gradually decreased. On calculating the amount of work accomplished during each of the pulsations in question, the following results are found:—

Weight applied.	. 0	50	100	150	200	250 gr.
Height of elevation .	14	9	7	5	2	0 mm.
Work accomplished .	0	450	700	750	400	0 mm.

The same results may be obtained with any other muscle. So that it may be stated as a very general proposition, that for each muscle there is a definite weight, on the application of which the greatest amount of work is accomplished by that muscle; when greater or less weight is applied, the amount of work accomplished is less. But the height of elevation corresponding with the application of one and the same weight is



not always the same in the case of different muscles. On comparing thick with thin muscles, it appears, in the first place, that the extension in the case of thick muscles becomes less in proportion as the weight applied increases; and that the decrease in the height of elevation corresponding to the increase in the weight applied proceeds less rapidly; so that much greater weights can be raised by thick than by thin muscles. On the other hand, it appears that in the case of muscles of equal thickness the height of elevation is greater in proportion as the muscle-fibres are longer. Under an equal weight the height of elevation increases proportionately with the length of the muscle-fibres. They decrease with increased weight; and they do this more rapidly in the case of thin than of thick muscles.

4. In calculating the amount of work accomplished by a muscle, only the raising of the weight is taken into consideration. When, however, the ordinary method of irritating the muscle is applied, the weight which is raised sinks back after each pulsation to its former height. The muscular work accomplished at each pulsation is, therefore, cancelled. It is probably converted into warmth. It is, however, possible to retain the weight at the height to which it was raised by the muscle. A. Fick accomplished this very ingeniously by causing the muscle to act on a light lever, which moves a wheel each time it rises, but leaves the same wheel undisturbed when it again sinks. A thread, on which the weight hangs, passes over the axis of the wheel. The effect of this arrangement is that the muscle at each pulsation turns the wheel slightly, and thus slowly raises the weight. If the muscle is made to pulsate frequently, the weight is raised somewhat higher each



time, and the final result is the sum of the work accomplished by the separate pulsations. Fick calls this apparatus a labour-accumulator (*Arbeitsammler*). It represents the method by which the whole work of all muscular efforts is summarised. When labourers lift a weight by means of a winch or windlass, a cog-wheel and drag-hook is applied to the axis in such a way that the wheel is free to revolve in one direction but not in the other. This gives cumulative effect to the separate muscular efforts which raise the weight; and the labourer is even able to make longer or shorter pauses without the result of the work already accomplished being cancelled by the falling back of the weight.

In tetanus the case is not the same as in separate pulsations. In the former the muscle at first accomplishes work by raising the weight, and then prevents it from falling by its own exertion. In addition to the height of elevation, it is, therefore, possible to distinguish also the carried height, that is to say, the height at which the weight is permanently supported. In doing this the muscle does not really accomplish any work in the mechanical sense; for work consists only in the raising of weight. In lifting a stone to the height of the table I accomplish definite work; the stone being placed on the table presses by its own weight on the latter; but the table though it prevents the stone from falling, cannot be said in so doing to accomplish work. So it is in the case of muscle. On raising a weight by means of the muscles of my arm to the height of my shoulder, and then holding out my arm horizontally, the muscles of the arm prevent the weight from falling; they act just as the table, and, therefore,

they accomplish no work in a mechanical sense. Yet everyone knows the difficulty of holding a weight long in this position; the sense of weariness which, very soon makes itself felt shows that work in a physiological sense is really done. The kind of work thus accomplished may be spoken of as the *internal* work of the muscle, as distinguished from the external work accomplished in the raising of weights.

5. We must now inquire on what the labour accomplished by the muscle as a whole depends. We are justified in assuming that here also, as in other cases, the work done does not originate in itself, but comes into existence in consequence of the exercise of some force. On examining a muscle during its active condition, we find that chemical processes occur within it which, though the details are not indeed fully known, must, since they are connected with the production of warmth and the evolution of carbonic acid, depend on the oxidation of a portion of the muscle-substance. Thus, the muscle acts like a steam-engine, in which work is accomplished in the same way by the evolution of warmth and the production of carbonic acid. So far all is clear; a portion of the substances of which the muscle is composed is oxidised during its active state, and the energy released by this chemical process is the source of the work accomplished by the muscle. The production of warmth in a muscle can be shown even during a single pulsation; but this production of warmth is far more noticeable during tetanus; and as warmth is but another form of motion, we may infer from this that the whole force resulting from the chemical process is converted into warmth during tetanus; while during the raising of a weight at the

commencement of the tetanic condition, or during each distinct pulsation, a portion of this force occurs in the form of mechanical work.

There is yet another fact which shows that internal motion must proceed within the muscle when contracted in tetanus, notwithstanding the quiescent condition in which externally it apparently is. A muscle when in this condition produces a sound or note. On placing an ear-trumpet on any muscle, for instance, on that of the upper arm, and then causing the muscle to contract, a deep buzzing noise is audible. This may also be loudly and distinctly heard on stopping the outer ear-passages with waxen plugs, and then contracting the muscles of the face; or by inserting the little finger firmly in the outer ear-passage and then contracting the muscles of the arm. In the latter case the bones of the arm conduct the muscle-note to the ear. This muscular note clearly shows that vibrations must occur within the muscle, however apparently unchanged the form of the latter may be. We found that tetanus thus apparently constant is induced by distinct irritants applied in quick succession. Helmholtz has shown that each of these irritations really corresponds with a vibration; for, if the number of the distinct irritations is altered, the muscle-note is also changed, the height of the muscle-note always corresponding exactly with the number of irritants applied. Though, therefore, no alteration in form can be perceived in the tetanised muscle, this can only be due to the fact that movements which occur among the particles within the muscle effect the note, though the external form remains unchanged. A somewhat similar phenomenon is observable in rods when caused to vibrate longitu-



dinally; for these also emit a sound although no change of form is externally perceptible.

This raises a question as to how many of these irritations are really requisite in order to bring a muscle into an enduring condition of contraction. By means of Wagner's hammer (fig. 12), just described, or by means of an electric wheel (fig. 11), the number of the irritations may be regulated. It will be found that from 16 to 18 distinct irritations in each second are quite sufficient to cause a constant contraction of the muscle. In a living body also, where the muscles are voluntarily contracted, the condition of tetanus appears to be produced by the same number of irritations. It has been found that the height of the muscle-note heard during voluntary contraction of the muscles is about equal to  $c^1$  or  $d^1$ , which represents from 32 to 36 vibrations in the second. But Helmholtz was able to show, with great probability, that this is not the true number of muscle-vibrations, but that the vibrations within the muscle are really only half as many. As, however, notes of this pitch are indistinguishable to our ears, we hear the next higher tone instead, which represents twice the number of vibrations.<sup>1</sup>

6. As yet we have noticed only the shortening of muscles. This alone determines the amount of labour accomplished, which consists in raising weights. But on looking at a contracted muscle, it is evident that it has become, not only shorter, but thicker. This

<sup>1</sup> According to Preyer, some men are capable of distinguishing notes of as many as fifteen to twenty-five vibrations per second; and, according to the same authority, the muscle-note sounds very like that produced by from eighteen to twenty vibrations per second, which corresponds very well with the views of Helmholtz.



raises the question whether the muscle in contracting has undergone no change in the amount of space occupied by it, or if its mass has become more dense. It is not easy to determine this accurately, for the alteration in the volume of the muscle can only be very slight. Experiments which have been made by P. Erman, E. Weber, and others, agree in showing that a very slight diminution in the muscle does certainly take place.

Remembering, however, that muscle consists of a moist substance, and that about three-fourths of its whole weight is water, even this slight decrease in volume must be the result of very considerable pressure—for fluids are extremely difficult of compression—unless possibly a portion of the water is expressed through the pores of the sarcolemma pouch.

More important than this structural change of the whole muscle is the change of form which each separate muscle-fibre undergoes. This may be observed under the microscope in thin and flat muscles, when it will be found that each muscle-fibre also becomes both shorter and thicker. On placing a muscle on a glass plate under the microscope, in order to observe this, the muscle, when the irritant ceases to act, is seen to remain apparently in its shortened form. But the separate muscle-fibres resume their former length as soon as the irritant ceases, and they therefore lie in a zigzag position until they are straightened by some external force. I merely mention this here, because the phenomenon is of historic interest. Prevost and Dumas, who were the first to examine this condition, believed that the contraction of the whole muscle was due to this zigzag bending of the muscle-fibres. With

the incomplete apparatus which they were then alone able to command, they were unable to induce an enduring irritation of the muscle; and they, therefore, confused the state of relaxation with that of contraction.

## CHAPTER IV.

1. Alteration in elasticity during contraction ; 2. Duration of contraction ; the myograph ; 3. Determination of electric time ; 4. Application of this to muscular pulsation ; 5. Burden and overburden—muscular force ; 6. Determination of muscular force in man ; 7. Alteration in muscular force during contraction.

1. We now approach one of the most remarkable of the facts connected with the general physiology of the muscles: this is the alteration in the elasticity of a muscle during its contraction. Even E. Weber, who first penetrated deeply in his researches into the subject of muscular contraction, showed that muscle is further extended by the same weight when it is in a state of activity than when it is quiescent. This is the more striking because the muscle becomes shorter and thicker during its activity, so that it should consequently be less extended; for, as we found, the extension by a definite weight is greater in proportion as the body extended is longer, and is less in proportion as the body extended is thicker. If, therefore, an active muscle is further extended than one that is inactive by the same weight, this can only be due to a change in its elasticity. It is hard to say how this occurs. The phenomena of contraction may, however, be explained by saying that muscle has two natural forms: one proper

to it, when it is in a quiescent state; the other, when it is active. When a quiescent muscle is brought into an active condition by irritation, it assumes a form which is no longer natural to it, it strives to attain the latter, and shortens until it reaches its new form, which is then natural to it. If the muscle is extended by a weight, and is then irritated, it immediately contracts; but only to that length which represents the extension by the attached weight, proper to its new form. Let us imagine that  $AB$ , in fig. 16, is the length of

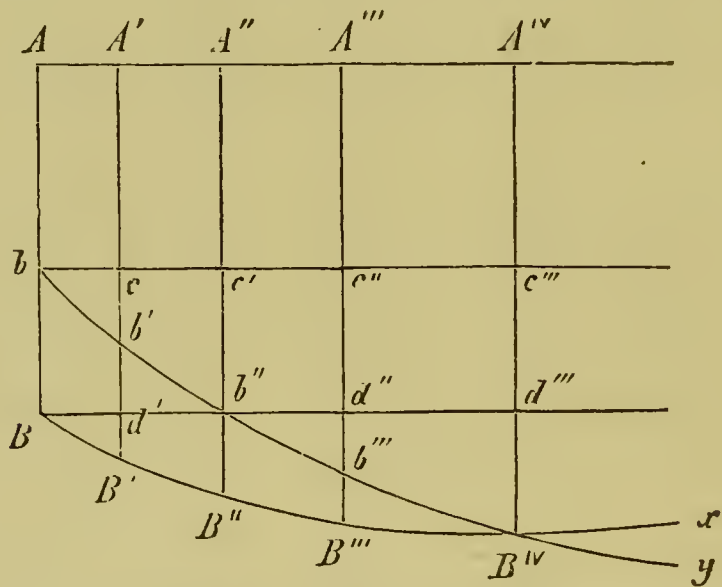

FIG. 16. ALTERATION IN ELASTICITY DURING CONTRACTION.

the muscle when quiescent and unburdened, and that  $Ab$  is the length of the muscle when active and unburdened. Then the muscle, if it is irritated while unweighted, will shorten to the extent represented by  $AB - Ab = bB$ ;  $bB$  is, therefore, the height of elevation of the unweighted muscle. If a weight  $p$  is attached to the muscle, the latter in its inactive condition will be extended to a certain degree ( $B'd'$ ); so that its length will now be  $AB + B'd' = A'B'$ . On being now irritated, it contracts and assumes a length



which must equal  $A B + c b' = A' b'$ , in which  $A b$  is the natural length of the active muscle when unweighted, and  $c b'$  is the extension which the active muscle undergoes on the application of the same weight  $p$ .  $A' B' - A' b' = b' B'$  is, therefore, the height of elevation of the muscle when the weight  $p$  is applied. Now, our former experiments have shown that the height of elevation decreases as the weight increases. The height of elevation  $b B$ , when the weight applied  $= 0$ , is, therefore, greater than the height of elevation  $b' B'$ , with the weight  $p$ . It therefore follows that the extension  $c b'$  must be greater than the extension  $d' B'$ ; or, in other words, the same weight,  $p$ , extends the muscle more when the latter is active than when it is quiescent. Calculating on this principle the curves of the extension of the active, as well as of the inactive, muscle, for the first we find the curve  $b b' y$ ; for the second the curve  $B B' x$ ; and these two continue gradually to approach each other, until they at last cut each other at the point  $B^{iv}$ . This point  $B^{iv}$ , which corresponds with the weight  $p$ , shows that when this weight is applied, the length of the active and the inactive muscles is equal. If, therefore, when the weight  $p$  is applied, the muscle is irritated, the height of elevation is nothing. The muscle is incapable of raising this weight, a fact which we have already noticed in previous experiments.<sup>1</sup>

Yet another point of great interest is observable in studying this alteration in the elasticity. When a certain weight,  $k$ , is applied, the extension of the active muscle  $= c' b''$ : that is, the active muscle, when this weight is applied, assumes exactly the length proper to

<sup>1</sup> See Notes and Additions, No. 1.

the quiescent muscle when unweighted. If an experiment is successfully arranged so that an inactive muscle is not extended by the weight  $k$ —by fastening the latter to the muscle, but immediately supporting it, so that it does not extend the muscle—and if the muscle is then irritated, it is evident that the muscle is incapable of raising this weight from its support. By finding the weight which is exactly sufficient to effect this, it is evident that we shall find an expression for the magnitude of the energy with which the muscle strives to pass from its natural into a contracted condition. This energy is called the *force* of the muscle. A method of accurately determining this will presently be explained.

2. As far as it is possible to examine the matter, the condition of muscles during their distinct pulsations is exactly as in tetanus. All that has been said of the height of elevation, and of the accomplishment of labour dependent on this, and of the alteration in the elasticity, is as true of distinct pulsations as of the tetanic condition. But it is very hard to observe the alteration in form during the very short time which is occupied by one of these pulsations. Means of drawing very accurate conclusions even on this point have, however, been found, especially since Helmholtz turned his attention to the matter, in 1852.

Various methods are employed in experimental research to measure very short periods of time accurately, and to study processes which occur even within the shortest periods. Not only has the speed of the cannon-ball during the various periods of its passage from the mouth of the cannon to its arrival at its destination been measured, but this has also been done in the case of the yet shorter time occupied by the explosion of

gunpowder. The duration of the electric spark alone yet remains unmeasured. This may, therefore, be regarded as really instantaneous, or at least as occupying a time shorter than any measurable period. Some observers have estimated its duration as less than  $\frac{1}{24000}$  of a second.

The most serviceable means of measuring very short periods is by causing the process to be measured to register itself on a rapidly moved surface, or by using an electric current the action of which depends on a magnet as regards its duration. Each of these methods has been applied to muscle.

Supposing a smooth surface, such as a glass plate, moved with great rapidity in its own plane, then a pointed wire turned at right angles to the plate will mark a straight line on the latter. If the plate has been smoked this line will be visible. Supposing the wire is attached to an instrument vibrating, like a tuning fork, upward and downward, then the line drawn by the pencil when the plate is moved will be not straight but waved. As the number of the vibrations may be told from the note which the vibrating instrument emits, it is known that the distance between each two waves of the waved line obtained represents a certain period of time. Assuming that the instrument makes 250 vibrations in each second, it is evident that the plate must have moved the distance between each two waves in  $\frac{1}{250}$  of a second. Now, if it is possible to cause a muscle-pulsation to register itself on the same plate, then from the distance of the separate parts of the line thus registered, when compared with the waves drawn by the vibrating instrument, the duration of time may be accurately



determined. The myograph of Helmholtz depends on this principle. Originally it consisted of a glass cylin-

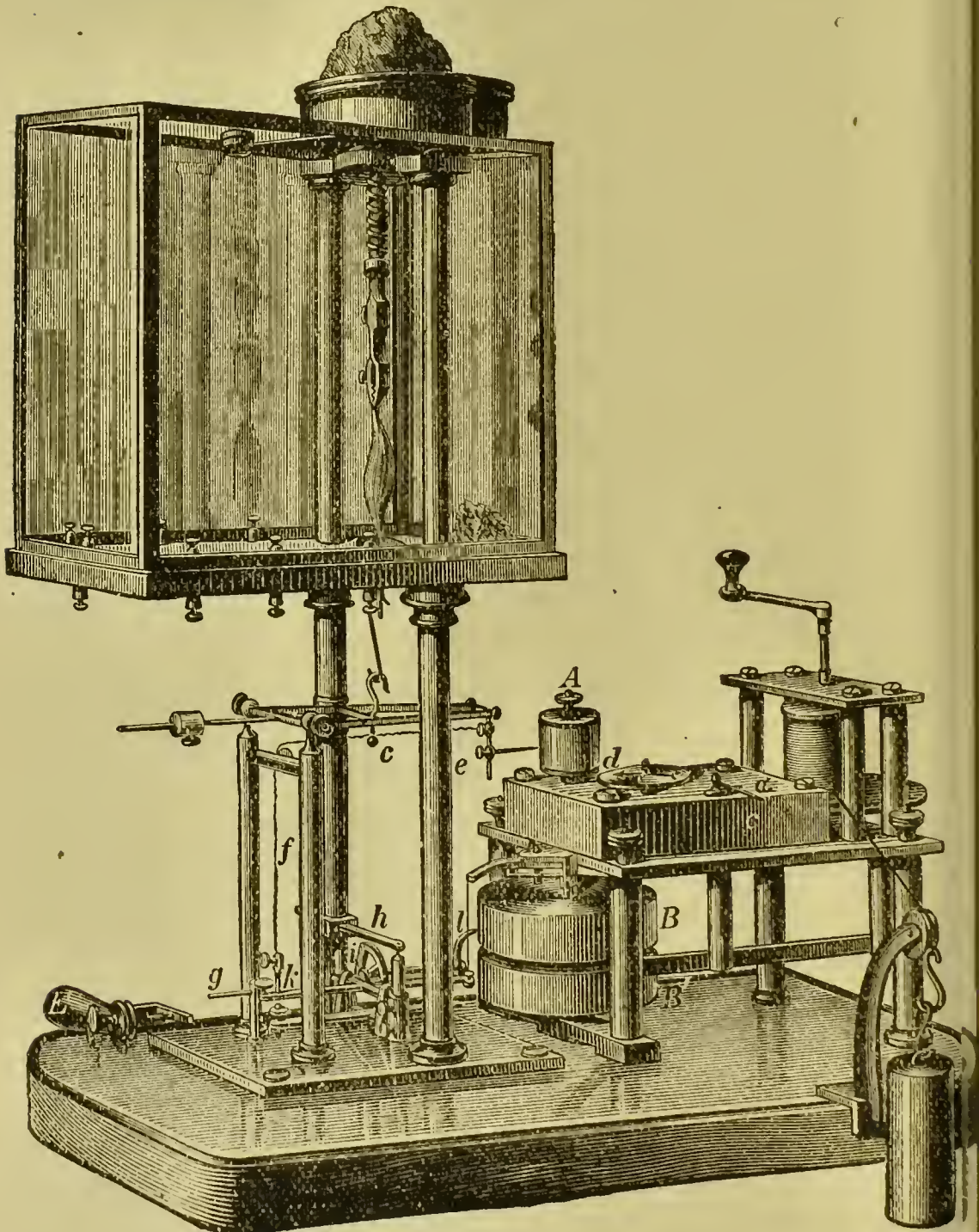

FIG. 17. MYOGRAPH OF HELMHOLTZ.  
(One quarter natural size.)

der which rotated rapidly on its own axis. The apparatus has, however, since undergone many alterations



Fig. 17 represents it in the form given to it by du Bois-Reymond. The clockwork enclosed in the case *c* sets the cylinder *A* in rotation. A heavy disc *B* is fastened on to the axis of the cylinder, on the lower surface of which are certain brass wings arranged vertically and immersed in oil. This oil is contained in the cylindrical vessel *B'*. By raising or lowering this vessel the amount of resistance offered to the rotatory motion may be graduated. This, together with the great weight of the heavy plate *B*, causes the rate of rotation of the cylinder *A* to increase but very slowly. As soon as a proper speed has been attained, the muscle is irritated; and this, on contracting, raises the lever *c* so that the point *e* fastened to the latter traces a curve on the cylinder.

To carry out the experiment, the muscle is fastened in a vice within the glass case, so as to prevent its drying up, and is then connected with the lever *c*; the cylinder *A* is covered with a coating of soot, and is then firmly fastened on its axis; the pointed indicator is brought into contact with the cylinder by means of the thread *f*. When this cylinder is slowly turned round by the hand, a horizontal line is inscribed on it by the indicator, and this represents the natural length of the quiescent muscle. On the circumference of the disc *B* is a projection called the 'nose.' When the disc together with the cylinder connected with it are in a certain position, this nose touches the bent bayonet-shaped angled lever *l*. When the latter is turned aside it raises the lever *h* by means of the arm *i*, thus breaking the contact of a current between the lever and the small column standing in front of it. The current of an electric chain is conducted through this

point of contact, and also through the primary coil of an inductive apparatus. The secondary coil is connected with the muscle. When, therefore, the *l*éver *l* is turned aside, the muscle is irritated. Accordingly it pulsates and raises the pencil of the index so that the latter marks a vertical line, representing the height of elevation of the muscle, on the cylinder *A*. By pressing the finger on *g*, the bayonet-shaped point *l* may be slightly raised, the index point *e* being at the same time slightly removed from the cylinder. The clockwork is then set in motion. The cylinder turns, at first slowly, but gradually more quickly; but the muscle remains inactive, and the point can make no mark. As soon as the cylinder has attained the desired speed the finger is removed; *l* sinks, and is soon after caught and turned aside by the nose, and the muscle, thus irritated, pulsates, and this pulsation is recorded on the cylinder during its rotation.

The irritation of the muscle being effected by the apparatus itself, it occurs when the rotating cylinder is in a definite position; that is to say, the cylinder is in that position in which the nose has just touched the end of the lever *l*. It is evident that this position is the same as that at which the muscle was at first allowed to pulsate when the cylinder stood still. The vertical line then drawn, therefore, indicates exactly the position of the cylinder at the moment at which irritation takes place. Where this vertical line deviates from the horizontal line first drawn is the point at which the pencil was when irritation was induced in the muscle. The distances from which the periods are to be calculated must be measured from this point.

In order to make the calculation, the rate of rotation of the cylinder must be accurately known, as uniformity in the time of registration of vibrations is not effected by the apparatus. As we have already seen, the rate of rotation of the cylinder is not uniform, but increasing; owing, however, to the weight of the disc *B* and of the immersion in oil, the increase is very gradual, and when a certain speed has been attained the resistance offered by the oil is so great that no further increase occurs and the speed remains constant. By means of the hand on the face *d* this speed can be determined; and it is easy to cause the cylinder to make exactly one revolution per second by adjusting the oil vessel of the apparatus.

The desired speed having been attained, it is only necessary to know the circumference of the cylinder in order to calculate the time value of that which is marked on the cylinder. In order to facilitate the measurement of the separate portions of the curve, the cylinder, after being carefully removed from its axis, must be fastened into a suitable forked handle (such as is represented in the left-hand lower corner of fig. 17, where it is marked *E*), and the cylinder must then be rolled on a sheet of moistened gelatine paper. The whole layer of soot adheres to the sticky gelatine; and the whole must then be fastened with the blackened side downward on to a white ground. The described curves will then appear in white on a black ground, and will admit of easy measurement.

Fig. 18 is accurately copied from a curve described in this way by the calf-muscle of a frog. The point at which the irritation occurred is marked *z*. It will at once strike the observer that the rising of the indicator



did not begin at the point  $z$ , but at some little distance beyond this, at  $a$ . From this it is to be inferred that the contraction of the muscle did not begin at the moment of irritation, for it is evident that the cylinder of the myograph had time to turn from  $z$  to  $a$  before the indicator was raised by the contraction of the muscle. A certain time, therefore, elapses before the change produced in the muscle by irritation results in contraction. The duration of this time—which can be accurately calculated from the length of the space existing between  $z$  and  $a$ —is about one-hundredth of a

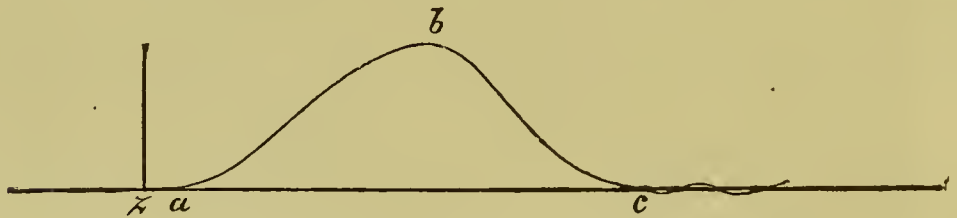

FIG. 18. THE CURVES OF A MUSCLE-PULSATION.

second. This stage is called that of *latent irritation*, for during it the irritation has not yet become actively efficient in the muscle. From the point  $a$  the muscle evidently contracts, as is shown by the rising of the pencil from point  $a$  to point  $b$ , which is the highest part of the curve described; from that point onward the muscle again lengthens till it resumes its original length at the point  $c$ . The time which elapses between the beginning of the contraction and its maximum is called the stage of increasing energy; the time from this maximum to that of the full re-extension of the muscle is that of the stage of decreasing energy. The whole duration of the muscular pulsation from the commencement of the contraction at  $a$  till complete extension is again reached at  $c$ , is from about one-tenth to one-sixth of a second.



3. In a similar way the different periods in muscular pulsation may be measured by means of an electric current. In order to understand this process, let us suppose a sudden push to be given to a heavy pendulum. The pendulum is thus caused to deflect from the vertical position proper to it when quiescent, the angle formed by its deflection depending on the force of the push which operated on it. Heavy pendulums of this sort, called ballistic pendulums, are used for measuring the speed of gun-shots. A magnetic needle which when suspended from a thread assumes a direction from north to south, may be regarded as a pendulum in which, in place of the force of gravitation, the magnetic attraction of the earth determines its position in a certain direction. If a sudden push is given to a pendulum of this sort, the force of the propulsion may be calculated in this case also from the degree of deflection. If a continuous electric current be conducted to a magnetic needle, the current being parallel to the needle, the latter deflects and assumes a position at an angle to the current, the magnitude of this angle depending on the strength of the current. The magnetic needle assumes a new position, the repelling force of the current and the magnetism of the earth counterbalancing each other. If, however, the current, instead of acting continuously, acts only for a short time, the magnetic needle suffers

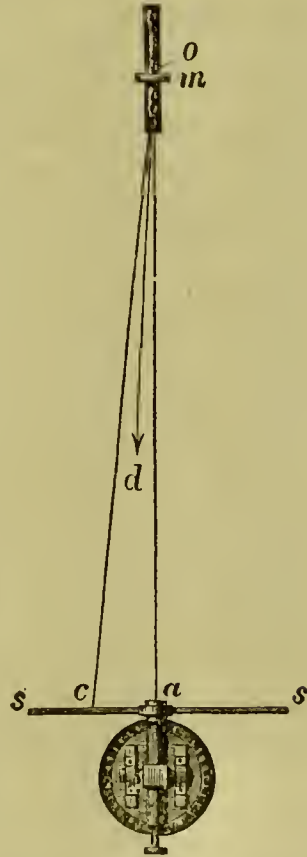

FIG. 19. MEASUREMENT OF SMALL ANGLES OF DEFLECTION WITH MIRROR AND LENS.

a push of but short duration and makes only a single vibration, after which it returns to the position proper to it when at rest. The degree of deflection must in this case be proportionate to the strength of the current and to the brevity of its duration. If, therefore, the strength is known and remains constant, the time occupied by the deflection may be calculated from its extent. Such deflections are generally very slight. In order, therefore, to measure them with certainty, an apparatus which was first applied by the celebrated mathematician Gauss is used. A small mirror *o* being connected with the magnet, a graduated scale *s s*, which is reflected in the mirror, is read by means of a magnifying glass. If the scale is placed parallel to the mirror when the magnet is at rest, and the magnifying glass is arranged at right angles to the direction of the mirror and of the scale, it is evident that exactly the point *a* on the scale which lies over the centre of the magnifying glass will be seen reflected in the mirror. As soon as the magnet with the mirror attached to it turns, the reflection of a different point on the fixed scale, the point *c*, is seen through the glass, and an observer looking at the mirror through the lens sees the scale apparently move in the same direction as that in which the mirror, together with the magnet, turns. From the extent of this change of position the angle which the magnet describes in its deflection may be calculated.

4. This method, by which the duration of electric currents may be measured with the greatest accuracy, must now be applied to our task of examining the duration of a muscle-pulsation. For this purpose we must find some arrangement by which an electric

current is closed at the instant at which the muscle is irritated, and to interrupt this current at the instant at which the contraction of the muscle begins.

This experiment also was first effected by Helmholtz. The apparatus used for the purpose is shown in fig. 20, in the altered form used by du Bois-Reymond. From a fixed stage rises a column to which a strong vice for the reception of one end of the muscle is attached in such a way that it can be moved upward or downward. The lower end of the muscle is fixed by means of a connecting piece *i h* with a lever which can be turned on the horizontal axis *a a'*. The lever is prolonged below into a short rod which, passing through a hole in the stage, supports at its foot a scale plate for weighting the muscle. On the fore-end of the lever are two screws *p* and *q*, the former of which ends below in a platinum point resting upon a platinum plate, while the latter is extended into a point of copper-amalgam, immersed in a capsule of quicksilver. The platinum plate and the capsule of quicksilver are isolated from the stage and from each other, the latter being conductively connected with the vice *k*, the former with *k'*.

If the current which is to act on the swinging magnet is inserted between *k* and *k'*, it passes through the quicksilver capsule, through the portion of the lever between *p* and *q*, through the platinum plate, &c., as long as the muscle does not contract. As soon, however, as the muscle contracts, it interrupts the current between *p* and the platinum plate. If the apparatus is so arranged that the current is closed at the moment at which any irritant affects the muscle, then this current will circulate until the muscle, in contracting, again



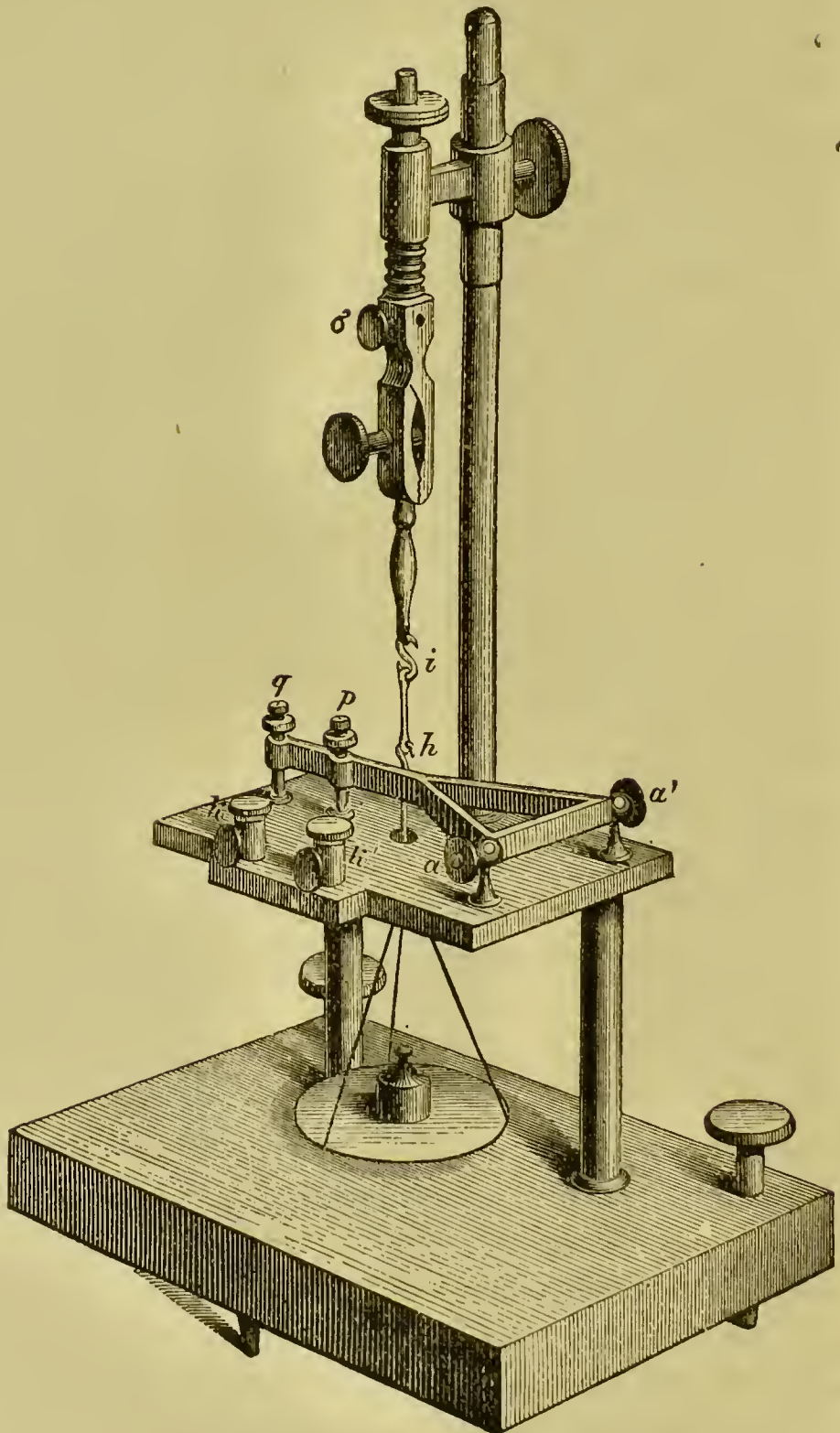

FIG. 20. APPARATUS FOR MEASURING THE DURATION OF MUSCLE-CONTRACTION.



interrupts the current. This period, which may be calculated by the method described in the last paragraph, represents exactly that which elapses from the moment at which the irritant affects the muscle to that at which contraction begins.

Yet another circumstance must be taken into consideration, in order to render actual measurements possible. The muscle contracts on being irritated. This contraction, however, lasts only a very few parts of a second, and the muscle then resumes its former length.

In the experiment just described, the current interrupted by the contraction of the muscle would soon be again completed, and the magnet would undergo a new deflection even before the first vibration was finished. In order to obviate this, Helmholtz employed means the nature of which is made

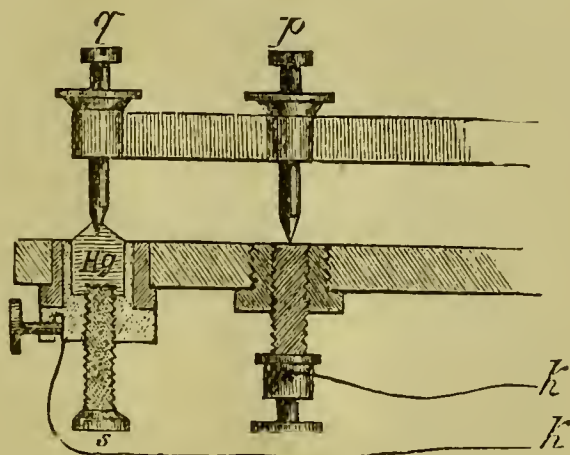

FIG. 21. THE END OF THE LEVER OF THE APPARATUS FOR TIME MEASUREMENT, TOGETHER WITH THE QUICKSILVER CAPSULE.

intelligible in fig. 21. This figure represents the end of the lever of the apparatus already described, together with the two screws *p* and *q*, the platinum plate and the quicksilver capsule; at *k* are the wires connecting the latter with the vices. The quicksilver in the capsule *Hg* can be raised or lowered by means of the screw *s*. If the level of the quicksilver is raised so as to immerse the point *q*, and if it is then again lowered, the quicksilver, by adhesion, remains hanging from the amalgamated point, and is by this means drawn out in the

form of a thin thread, through which the current may pass. When, however, the muscle shortens the quick-silver is torn away, and resumes its ordinary convex surface; and when, on the extension of the muscle,

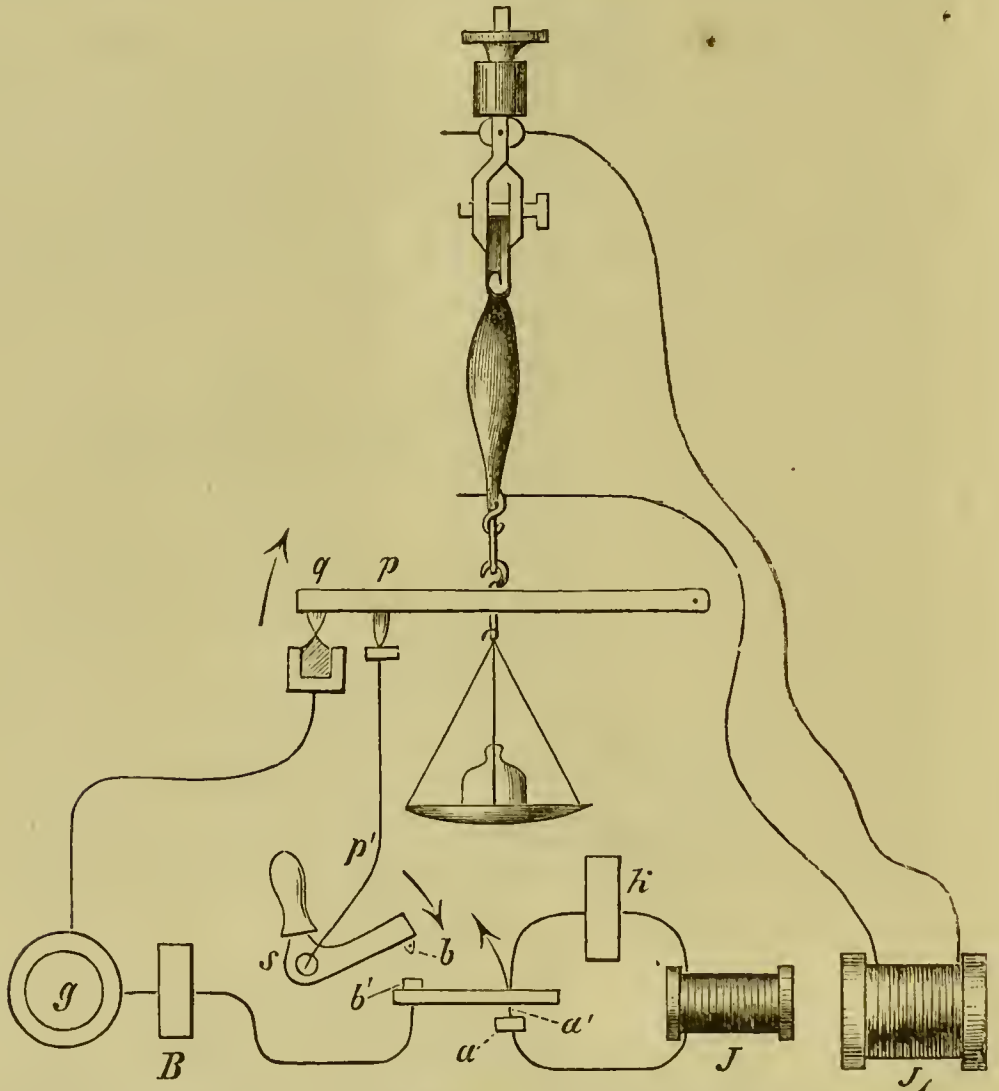

FIG. 22. DIAGRAM OF EXPERIMENT FOR THE ELECTRIC MEASUREMENT OF TIME.

the lever again sinks, though the point *p* again rests on the platinum plate, yet the point *q* remains separated from the quicksilver by an intermediate air-filled space, and the current remains permanently interrupted.

It still has to be explained how the irritation of the muscle and the closing of the time-determining current

are effected exactly at the moment of irritation. A clear idea of this will be gained by examining fig. 22, in which the arrangement of the whole experiment is diagrammatically represented. The muscle and the apparatus represented in fig. 20 are again shown. The muscle is connected with the secondary coil of the inductive apparatus  $J'$ . In the primary coil  $J$  circulates a current from the chain  $K$ . This current passes through the platinum plate  $a$ , and through the platinum point  $a'$ .  $a'$  is attached to a lever of hard wood,  $a' b'$ , and is pressed by a spring against the platinum plate  $a$ . At the other end of the lever is the platinum plate  $b'$ , which is connected with the battery  $B$ . The other pole of the battery is in connection with the galvanometer  $g$ , which latter is itself connected with the quicksilver capsule of the apparatus represented in fig. 20. Over, but not touching, the platinum plate  $b'$  is the platinum point  $b$ , and this is connected with the platinum plate of the same apparatus by the conductive material of the key  $s$ , and of the wire  $k'$ . On pressing down the key  $s$  by the handle, the platinum point  $b$  comes in contact with the platinum plate  $b'$ , and the current by which the time is to be measured is closed. At the same time, however, the end  $a'$  of the lever  $a' b'$  is raised, and the current of the chain  $K$  is interrupted. This produces an inductive current in the coil  $J'$ , and this irritates the muscle. Irritation is, therefore, induced exactly at the moment at which the time-determining current is closed.

As soon as the muscle contracts, it interrupts the time-determining current. This, therefore, lasts from the moment of irritation to that at which the pulsation commences. In this, therefore, we measure that which



we called the stage of latent irritation. When, however, weights are placed on the scale of the apparatus (fig. 20), the resulting deflections of the magnetic needle are different, and are greater in proportion as the weight applied is heavier. As the lever connected with the muscle rests on, and is supported by, the plate below it, the weights placed in the scale-plate cannot extend the muscle; they only increase the pressure of the platinum point  $p$  on the underlying platinum plate. Before the muscle can contract after irritation, the tendency to contraction must be greater than this pressure, or than the tension which is exercised from below by the weight on the lever. As the muscle strives to draw up the lever, while the weight, on the other hand, draws it downward, the greater force obtains the mastery. It will be evident from what has been said that the muscle acquires the force with which it strives to contract, not suddenly, but very gradually. At the moment at which this contracting force becomes slightly greater than the weight applied, it is able to raise the lever, and in so doing to interrupt the current which determines the time. If, in a series of consecutive experiments, heavier weights are each time placed in the scale of the apparatus, and if the deflections of the magnetic needle resulting from this are measured, this determines the periods in which the muscle attains a tendency to contraction equivalent to the weight. We will call this force, the energy of the muscle. So long as the muscle does not contract at all—that is, throughout the stage of latent irritation—its energy = 0. From the periods which we find as the result of the application of increasing weights, it appears that this energy increases, at first rapidly and then more slowly, reaching its maxi-



mum in about one-tenth of a second. The maximum having been reached, the muscle is unable to contract further. The energy diminishes, and finally disappears, the muscle returning to its original condition.

5. In the experiments described above, weights were connected with the muscle which the latter necessarily raised as soon as it strove to contract; but these weights did not act upon the muscle as long as it remained quiescent. It was, therefore, not weighted in the sense which has already been described; for the weights attached were unable to extend the muscle. The comparatively slight weight of the lever alone extended the muscle, and could be regarded as burden in the ordinary sense. In order to distinguish these weights, which are without effect until the muscle strives to contract from weight in the ordinary sense, we will apply the term 'over-burden' to them. The burden of a muscle may be great or small. In the experiments described above it was equal to the weight of the lever. Greater weights may be selected, a weight being placed upon the scale-plate and the muscle being then raised by means of the screw at the top of the apparatus, so long as the platinum point  $p$  still rests on the platinum plate. The muscle is then extended by the weight applied. If additional weight is added to that already on the scale-plate, the former acts as burden, the latter as over-burden. When a muscle thus circumstanced contracts, it has to lift both weights. Let us return to our first series of experiments, in which the weight = 0, or was at least very small. If more and more over-burden is gradually added, it is evident that a point will be reached at which the muscle will no longer be able to lift the weight. This point may be very accurately

determined by inserting a chain and an electro-magnet between the vices  $k$  and  $k'$ . The electric current then passes through the platinum point, the corresponding lever, the quicksilver capsule, and the coils of the electro-magnet. The latter becomes magnetic, and attracts an armature. As soon, however, as the current is interrupted by the contraction of the muscle, the electro-magnet sets the armature free, and the latter, striking against a bell, gives a signal which shows that the muscle has contracted. In this way even very minute contractions of the muscle are recognised. If the weights which act as over-burden, and counter-balance the tendency to contraction in the muscle, are gradually increased, a limit is reached at which, in spite of the irritation of the muscle, the current of the electro-magnet is no longer interrupted. The muscle is indeed irritated, and a tendency to contraction is generated within it; but this is not sufficiently great to overcome the weight used; and the muscle, therefore, remains uncontracted. In this way the extent to which the tendency of a muscle to contract—or its energy, as we called it, can increase—may be found. This extreme limit of its energy is called the *force* of a muscle. It is the same in amount as that which we theoretically inferred (p. 48) from the change in the elasticity of a muscle during contraction. Each muscle has a definite force dependent on the conditions of its nourishment and on its form. On comparing the muscles of the same animal, it appears that the force is dependent in no way on the length of the muscle-fibres, but on the number of these fibres, or, in other words, on the diameter of the muscle; and that the force increases in exact proportion with the diameter of the muscle. So that a

muscle of double thickness therefore possesses double force. It is usual, therefore, to refer the force to units of diameter of the muscle, by dividing the force by the diameter of the muscle, and thus to calculate the force of a muscle of 1 square centimetre diameter.<sup>1</sup> It has been found that in the muscles of the frog the force, for a diameter of 1 centimetre, is about 2·8 to 3 kilogrammes; that is to say, a muscle of 1 centimetre in diameter can attain a maximum tendency to contraction which a weight of 3 kilogrammes is capable of resisting. This value of the force reduced to units of diameter is called the *absolute force* of a muscle.

6. An attempt has been made to determine the absolute muscular force in the case of man also. Edward Weber first tried to do this by an ingenious method. The muscles of the calf were chosen for the experiment. On standing upright and contracting these, the heels, and at the same time the whole body, are raised from the ground. Gymnasts call this balancing. The whole force of the calf-muscles of both legs is therefore greater than the weight of the body. If the body is weighted, a limit is reached at which it is no longer possible to balance. The total weight of the body together with that of all the weights applied, therefore, equals the force of the muscles of the calf; but in calculating this, however, attention must be paid to the fact that the force and the burden do not act on the same lever,

<sup>1</sup> The following method, adopted by Ed. Weber, is used to determine the diameter. The weight of the muscle, which is found by the use of scales, is multiplied together with the specific weight of the muscle-substance, the result being the volume of the muscle. The length of the muscle is then measured, and the volume is divided by the length, which gives the diameter.



and that the force—the tension exercised by the muscles of the calf—acts obliquely on the lever. It is of course impossible to determine the diameter in a living man; it must be observed in a dead body of about the same size as that of the person experimented on.

Henke also has lately determined the value of the absolute force of human muscle. He used the flexor muscles of the forearm (cf. fig. 23) to determine this. In the figure, *a* represents the upper arm, *b* the fore-

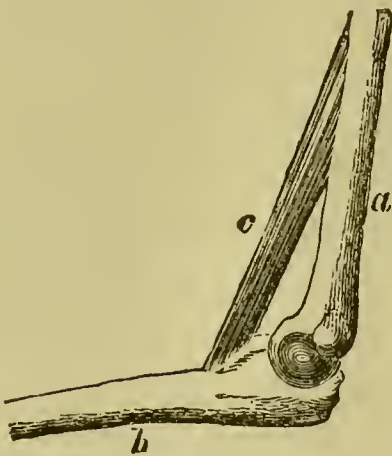

FIG. 23. DIAGRAM OF THE FLEXOR MUSCLES OF THE FOREARM.

arm—the former being in a vertical, the latter in a horizontal position; *c* represents the muscles which raise or bend the forearm. (There are in reality two of these muscles, *M. biceps* and *M. brachialis internus*). Supposing that the muscles are stretched, and weights are placed on the hand till the muscles are no longer capable of raising the hand, then, just as in the experiments with the muscles of frogs, equipoise is

obtained between the tendency of the muscle to contract and the weight carried. Care must, however, be taken that the muscles act on a long lever arm, the weight on a short one, and the weight of the forearm itself must also be taken into consideration. Due attention being given to all these circumstances, and to the diameter of the muscles when drawn into action, Henke calculated that the absolute force in human muscle is equal to from six to eight kilogrammes. Experimenting in a similar way on the feet, he found somewhat lower figures in that case. Weber, however,



in his results as regards the calf-muscles, found much lower figures. But in this case, errors in calculation evidently occurred, and explain the difference.

To determine the muscles of the forearm which bend the fingers, a dynamometer, as represented in fig. 24, may be used. The strong spring handle of steel, *A*, being grasped with both hands, is pressed together with the whole strength. The alteration in the curves which is effected in the instrument at the points *d* and *d'*, is transmitted by the lever *a b a'* to the index *c*, which indicates in kilogrammes the amount of force exercised on the graduated scale *B*. A somewhat elaborate calculation would be necessary to find from this the absolute force of the muscles employed. If, however, the force which men are generally able to exercise with their hands is known, the apparatus may be conveniently used to detect occasional variations, such as occur, for instance, at the commencement of lameness and other diseases of the locomotive apparatus. The dynamometer has, therefore, become of importance in the investigation of diseases.

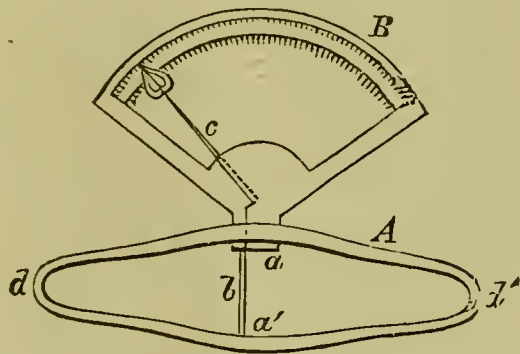

FIG. 24. DYNAMOMETER.

7. We have already observed that a muscle during a single pulsation attains its full force, not at once, but only gradually, and we have seen the way in which the periods necessary for attaining the different values of the energy may be determined by means of the electric method of measuring time. If the muscle contracts freely, little or no weight being attached, it exhibits

this energy during each instant in the form of increase in speed which it imparts to its lower end and to the slight weight attached to the latter. We may now raise the question as to the amount of force which the muscle when it has already accomplished part, say, one half, of its contraction, can still evolve. Schwann, who first raised the question, fastened a muscle to one end of the beam of a scale and attached weights to the other end, but supported this end in such a way that the muscle was not extended. He was thus able to determine the force of the muscle in the same way as was described above with the apparatus shown in fig. 20, which depends on exactly the same principle. L. Hermann repeated Schwann's experiment with this apparatus, which is more convenient for the purpose now under discussion. The unweighted, or, at least, very slightly weighted, muscle having been inserted in the apparatus as accurately as possible, so that the platinum point  $p$  just rests on the plate, the muscular force is determined in the way described above (see pp. 65, 67). The vice which carries the muscle is then lowered to a certain definite extent, say 1 mm. If the muscle is then irritated it can become shorter by 1 mm. before it pulls the lever  $h$ ; if it becomes yet shorter it must raise the lever with the weights attached to it. The weight which it can still lift after it has become shorter by 1 mm. may thus be found. The muscle-vice is then again lowered—and this is again and again repeated. A series of weight-values is thus obtained which correspond with the force of the muscle during the different stages of its contraction. The result of the experiment is to show that the force of the muscle decreases, slowly at the commencement of contraction, but afterwards

more rapidly. The muscle having contracted as far as possible without any weight, it can naturally no longer raise any weight—its whole energy is expended.

The interest of this experiment lies in the fact that it shows in a different way that which we have already said (p. 48) as to change in elasticity during contraction. For these experiments determine the weight proper to each length of the active muscle, so that we can also directly deduce from these the curves of extension of an active muscle, which we had previously constructed only theoretically. The agreement of this deduction with the theory, found in a different way, is an important confirmation of the views which we have developed as to the bearing of the conditions of elasticity on the labour accomplished by the muscle.

## CHAPTER V.

1. Chemical processes within the muscle ; 2. Generation of warmth during contraction ; 3. Exhaustion and recovery ; 4. Source of muscle-force ; 5. Death of the muscle ; 6. Death-stiffening (*Rigor mortis*).

1. The relations just described between the elasticity and the work accomplished by the muscle have led us to suppose that a muscle has, as it were, two natural forms, one corresponding to its condition of rest, the other—a shorter form—corresponding to its active condition. Irritation induces the muscle to pass from one form into the other, and in so doing it contracts. This is, however, rather a description than an explanation of the fact of contraction. As the muscle on contraction is capable of raising weight, and thus of accomplishing work, it is necessary to inquire how this labour is effected. According to the law of the conservation of energy, the labour so accomplished can only come into existence at the expense of some other energy. Now, it can be proved that chemical processes proceed within the muscle during muscular contraction, while others, which proceed even in the quiescent muscle, are increased in degree during this same contraction. The mechanical work must, therefore, be accomplished at the expense of these chemical processes ; and it could



be proved that the amount of work accomplished corresponds exactly with these chemical changes.

It is easy to show that chemical processes occur within the muscle; but it is not so easy to determine these quantitatively, so that we are as yet unable to solve the question raised. Helmholtz long ago pointed out the fact that during muscular contraction such constituents of the muscle as are soluble in water decrease, while such as are soluble in alcohol increase. E. du Bois-Reymond showed that an acid—probably a lactic acid (*Fleischmilchsäure*)—is generated in the muscle during its activity. Quiescent muscles also contain a certain amount of a starch-like matter called glycogen; and, as Nasse and Weiss have shown, part of the glycogen is used up during the activity of the muscle, and is transformed into sugar and lactic acid. Finally, it can be shown that carbonic acid is generated in the muscle during its contraction. All these chemical changes are capable of producing warmth and work. In determining whether the whole amount of work accomplished is referable to this source, yet another special difficulty exists in the fact that, as in other machines, warmth is also produced as well as mechanical work. A muscle certainly grows warmer during its contraction, as Béclard and, with yet greater certainty, Helmholtz have shown. With suitable apparatus it is possible to indicate an increase in the warmth of a muscle even during a single contraction.

Our knowledge of the chemical constituents of muscle is yet very incomplete. Not only is chemistry as yet unprovided with adequate means of examining albuminous bodies, which are the chief constituents of muscles, but a special difficulty also exists in the great tendency to change in the constituent matter of living

muscle. The methods usually employed in chemistry for the separation and isolation of different substances are of no avail in this case, since they essentially alter the nature of the muscle. We must, therefore, be satisfied to assume as certain only that various albuminous bodies occur in the muscle, one of which, called myosin, appears to be peculiar to muscle, and of which others are the non-nitrogenous bodies glycogen and inosit, together with a certain amount of fat and a number of salts. It appears somewhat doubtful whether lactic acid, which is always present in the muscle, if but in small quantities, is to be regarded as a normal constituent of muscle substance, or if it is not rather a product of decomposition. The same may be said of the gaseous carbonic acid which, like the lactic acid, is probably only formed during the activity of the muscle, and also of the nitrogenous bodies, such as creatin, which are present in small quantities in muscle, and which must probably also be regarded only as the products of the dissolution of the albuminous bodies.

2. The only conclusion to be drawn from this fragmentary information is that part of the muscle-substance unites during the activity of the muscle with oxygen, forming, partly carbonic acid, partly less highly oxidised products. That warmth is generated during these processes of oxidation, as we have above stated, is not surprising. To show this generation of warmth, Helmholtz employed the thermo-electric method. An electric current rises in a circle composed of two different metals, e.g. copper and iron, as soon as both points of contact—the points where the metals meet or are soldered together—acquire unequal temperatures. The strength of this current is proportionate to the difference in temperature,

and thus, from the strength of the current, it is possible to determine the temperature of one point of contact if that of the other is known. In our case, in which it is not necessary to determine absolute temperatures, but only to show an increase in warmth, the method is more simple. It is only necessary to provide that the two points of contact have the same temperature at first, a condition which can be recognised by the absence of any current, and the additional degree of warmth acquired can then be directly calculated from the strength of the current which is afterwards generated.

Helmholtz performed the experiment by placing the two thighs of a frog which had been recently killed in a closed case, after he had so arranged the metals which were to determine the warmth that one point of contact was inserted in the muscles of one thigh, the other in those of the other. He then waited till the temperatures of both thighs became equal, so that, though the metals were connected with a sensitive multiplier, no current was apparent. The muscles of one thigh were thrown into strong tetanus by introducing a suitable inductive current, while those of the other thigh remained at rest. The contracted muscles then became warmer and imparted their warmth to the soldered metals embedded in them; the result was an electric current the strength of which was measured. The increase in the warmth of the muscle, thus determined, was about  $\cdot 15$  of a degree. This warmth may seem slight, but it must be remembered that but a small mass of muscle was treated, and that this necessarily lost a considerable part of the warmth generated within it by radiation and by imparting it to the surrounding substances.



In order to form some conception of the amount of warmth thus generated, we will assume that the specific warmth of muscle is the same as that of water. As the greater part of muscle consists of water,<sup>1</sup> this assumption cannot be far wrong. By the specific warmth of a substance is meant that amount of warmth which is necessary to warm one gramme of the substance exactly one degree, the amount necessary in the case of water being regarded as the unit. Therefore about one unit of warmth is requisite to warm one gramme of muscle substance one degree. According to our assumption, in each gramme of muscle substance at least  $\cdot 15$  of a unit of warmth is generated. Now it is known that each unit of warmth is equivalent to 424 units of work, that is to say, when warmth is transformed into mechanical work, 424 grammes can be raised one metre by one unit of warmth. If, therefore, no warmth were set free from the muscle during tetanus, but if it were transformed into work, each gramme of muscle substance would be able to raise  $424 \div 0\cdot 15$  gramme to the height of one metre. This amount, therefore, represents the minimum of that which is accomplished as 'internal work' in the muscle during tetanus.

By soldering rods or strips of two metals alternately on to each other so that all the points soldered are arranged in two planes, differences in temperature much more minute than those which occur during tetanus may be measured. Such an apparatus is called a thermopile. Heidenhain had one of these made of rods of

<sup>1</sup> According to a recent statement of Dr. Adamkiewicz, the specific warmth of muscle is even greater than that of water, though it had previously been assumed that the specific warmth of water is greater than that of any other known substance, with the exception of hydrogen.



antimony and bismuth, and having covered the surface of each of the ends with a muscle from the lower leg of a frog, he waited until both had assumed an equal temperature. He then by irritation induced activity in one muscle, and owing to the sensitiveness of the apparatus he was not only able to determine the warmth arising during a single pulsation, but even to indicate differences in this according to the circumstances (burden, &c) under which the pulsation occurred.

The law of the conservation of energy would lead us to expect that in cases in which the muscle accomplished a greater amount of mechanical work, the production of warmth would be less, and *vice versâ*. When weights are applied, as burden, to the muscle, the labour performed increases, as we found, up to a certain point with every increase in weight. The generation of warmth should accordingly decrease in this case. This was not, however, the case in the experiments made by Heidenhain. As we cannot suppose that the law of the conservation of energy,<sup>1</sup> which is elsewhere throughout nature universally valid, is invalid as regards muscle, we can only suppose that the number of chemical modifications occurring at each muscular pulsation is not always the same, but that when greater weight is applied a larger amount of substances are consumed in the muscle, so that both the production of warmth and the work accomplished may, though the irritant remains the same, differ according to the degree of tension of the muscle. On the other hand, it is quite in accordance with the law of the conservation of energy that the muscle generates

<sup>1</sup> On this law see the admirable work of Balfour Stewart (International Scientific Series, vol. vi.).

the greatest amount of warmth during tetanus, during which no apparent labour is accomplished. The whole internal work of the muscle is in this case transformed into warmth, thus raising the temperature of the muscle-substance; and the amount of this warmth may, as we have seen, be at least approximately measured and calculated.

3. One result of the chemical changes which occur within the muscle during its activity, is naturally that part of the constituent matter of the muscle is expended, other matter being deposited in its place. As long as the muscle remains uninjured within the body of the animal, part of the matter thus formed is carried away, and fresh nutritive matter is brought to replace the expended material. The products which arise by decomposition during the activity of the muscle may therefore be indicated in the blood of the animal, and from the blood they are removed from out of the body by special excretory organs. Accordingly we find that the amount of carbonic acid excreted is considerably increased by muscular labour, and that the other products of muscular decomposition, such as creatin and the urea arising from the latter, lactic acid, &c., reappear in the urine. The more abundantly the blood-current flows through the muscles, the more quickly are the products of decomposition removed from the muscle. This is of course possible only in a very inferior degree when the muscle has been cut out from the body. This is the reason why an extracted muscle retains its power of activity for but a very short time. If, for instance, such a muscle is continuously tetanised, it will be found that the contraction, though it is at first very considerable, very soon decreases and

finally entirely ceases. The muscle is then said to be exhausted. But if it is allowed to rest it recovers itself so that it can again be induced to contract. This recovery is, however, never complete, and with each repetition of the experiment it becomes more defective, the intervals requisite for recovery becoming continually longer, and the muscle finally remaining incapable of further contraction. If the muscle is not tetanised, but distinct pulsations are induced in it by separate irritants, it retains its power of activity for a very long time. From this it may be inferred that a portion of the products of decomposition perhaps reform; or it may be assumed that the muscle contains a large amount of matter capable of disintegration, but that this is capable of only gradual decomposition. So long as the blood continues to flow through the muscle, the products of decomposition are, as we have seen, soon carried away; but as exhaustion occurs in this case also, we must draw the same conclusion, that the decomposable matter present can undergo decomposition only gradually, and that therefore in this case also intervals must necessarily occur between the separate exercises of activity. A muscle while undisturbed within the organism essentially differs from one that has been extracted in that in the former the expended material can be fully replaced. Accordingly, it is not only capable of again becoming active after an interval of rest, but, provided that the matter added exceeds that which was expended, it is afterward capable of performing more work than it was previously. To this is due the fact that the strength of muscle is increased by a proper alternation of rest and activity.

4. We have now to discover which of the substances



within the muscle are expended during its activity. As muscle consists principally of albuminous bodies, it has been assumed that it is to the decomposition of these that the labour accomplished is due. We have, however, seen that non-nitrogenous bodies, such as glycogen and muscle-sugar, are also contained in the muscle, and that lactic acid, which must originate from the latter, is formed during the active state. Although it is impossible to determine the products of decomposition within a single muscle, yet this may be done in the case of the whole mass of the muscles of the body during an activity of long continuance; for the products of decomposition finally pass into the excretions, and it is evident that the whole amount of addition to the excretions may be regarded as a measure of the decomposition in the active muscles. The nitrogenous constituents of muscle are almost without exception excreted in the form of urea with the urine. At least the amount of nitrogen contained in the other excretory products is so very small that it may safely be disregarded. Now, the amount of urea contained in the urine may be determined with very great accuracy. Even when the body is in a state of complete rest—though even then a considerable amount of work is performed in the body, in the action of the heart and of the respiratory muscles—the excretion of urea depends entirely on the amount of nitrogen introduced in food. If entirely non-nitrogenous food is taken, then the excretion of urea decreases to a definite point, at which it remains constant for some time. If a larger amount of work is performed, a slight increase in the excretion of urea in fact usually occurs. The amount of albuminous matter which must be modified



within the body in order to afford this increase in the amount of urea excreted may be calculated. Now, the equivalent in warmth of albuminous bodies is known; that is, the amount of warmth produced by the combustion of a definite weight of albuminous matter is known. And, as the mechanical equivalent of warmth is also known, the amount of work which could be produced by these albuminous bodies under favourable circumstances may, therefore, also be calculated. When this value in work is compared with the amount of work really accomplished, the figures found are always far too low. From this it may safely be inferred that the albuminous matter which undergoes combustion within the body is not capable of affording the work which is performed, and we must rather assume that other substances also undergo combustion, and contribute to the labour performed, contribute indeed even the greater part of such labour. If, on the other hand, the amount of carbonic acid excreted by a man during rest is compared with that excreted during greater labour, the increase is found to be very great indeed, and on calculating the amount of labour which should result from the combustion of a corresponding mass of carbon, the amount found corresponds nearly enough with that of the work really performed.

This experiment, therefore, shows that the muscles generate their work not so much at the expense of albuminous bodies as by the combustion of non-nitrogenous matter. The addition of matter required by the body if it is to remain in a condition capable of labour must, therefore, be regulated accordingly. Hence follows the conclusion, of the greatest importance with reference to the question of diet, that men who have

to perform a great amount of labour require food abounding in carbon. The opposite was formerly assumed, the view being founded on the fact that English labourers, who are, as a rule, more capable of work than French peasants, eat more meat, which is a highly nitrogenous substance. It used also to be pointed out that the larger beasts of prey, which feed exclusively on flesh, are remarkable for their great muscular power. Neither instance really proves the conclusion which it was intended should be drawn from it. In the first place, as regards English labourers, more accurate observation of the food usually consumed by them has shown that, in addition to meat, very considerable quantities of food abounding in carbon, such as bread, potatoes, rice, and so on, are taken. As regards the beasts of prey, it is impossible to deny that they are capable of very great labour; but in this case, also, closer observation shows that the whole amount of work accomplished by them is, at any rate, very small when compared with the constant work of a draught horse or ox.

The relation of the food to the work performed by the muscles must evidently be regarded as similar to the relation borne by the fuel consumed by an engine boiler to the work performed by a steam-engine. Everyone knows that coal is burned under the boiler, and that this is finally transformed into work by the mechanism of the machine. The same work might be produced by the combustion of nitrogenous matter; but it would be necessary to use considerably greater quantities. But the machine called muscle cannot be driven by pure carbon; under the conditions presented by the organism pure carbon cannot be applied to the

production of work, as it cannot be digested, and, owing to the low temperature of the body, cannot be oxidised. But combinations abounding in carbon, such as are at hand in the carbon hydrates (starch, sugar, &c.) and in fats, are fitted for the purpose, and a given weight of these affords a considerably greater amount of work than can an equal weight of nitrogenous albumens. If, therefore, the muscle is capable, by the combustion of the non-nitrogenous bodies which it contains, of accomplishing labour, it is evident that this relation is similar to that in the case of the steam-engine, in which the work is accomplished by the combustion of carbon.

It has been objected that the amount of non-nitrogenous substance within the muscle is very small, but the objection is scarcely tenable. If a whole steam-engine with its boiler and the coal in the furnace could be subjected to a chemical analysis, the percentage of coal in the whole mass would of course be found to be very small. But it is not by the amount of coal present at any given moment that the work is performed, but by the whole amount which in the course of a considerable time is added little by little by the stoker. In the case of muscle the blood acts the part of the stoker. It continually adds matter to the muscle, and the products of combustion resulting from labour escape from the muscle, just as the carbonic acid does from the chimney of the steam-engine. It is evident that the amount of carbon consumed by a steam-engine might be accurately determined by collecting and analysing the carbonic acid which escapes from the chimney. We proceed in exactly the same way in the case of the muscle. The lungs represent the chimney; the carbonic acid escaping from these may be collected,



and from this the amount of carbon which must be consumed may be calculated. Whatever does not escape in the form of gas during combustion remains behind as ash. The ash of the fire of the steam-engine is represented by the urea and other matter which passes from the muscles into the urine. The whole amount of both must correspond exactly with the whole amount of the products resulting from combustion within the muscle.

Although the small amount of the non-nitrogenous substances present in the muscle does not, therefore, prevent us from regarding them as the main source of muscular labour, yet in one point the machine called muscle differs from the steam-engine, which it otherwise so strikingly resembles. We found that the excretion of urea undergoes an increase, though this may not be very great, when the muscular labour is increased. It is, therefore, evident that there must be a greater destruction of the chief constituents of muscle-substance, of the tissue of which muscle is mainly formed, and which may be compared to the metallic parts of the steam-engine. Even in the latter a waste of the metallic parts occurs; but this is comparatively very small in degree. The muscular machine is not constructed of such durable material; during its activity it, therefore, continually wastes a comparatively considerable amount of its own substance. As the matter leaves the body in a more highly oxidised form than it had when it was present in the muscle, warmth and work must also be freed during this partial combustion of the material of the machine. The muscle-machine works, therefore, partly at the expense of its own form-element; and, if it is to work continuously, not



only must the main fuel, but also matter to replace the form-element must be constantly added. The more closely the composition of the food consumed corresponds with the material expended, the more complete will be the replacement which can occur. The expenditure of non-nitrogenous substance is, as we found, comparatively great, so that it would be entirely wrong to try to supply the loss merely with nitrogenous matter. All experience in the nourishment of labouring men and animals fully confirms this. The addition of nitrogenous matter is necessary, to keep the muscles in good condition; but a yet more abundant addition of carbon compounds, such as are afforded by the non-nitrogenous food materials, is required, in order to supply the necessary amount of the chief producer of labour. The wood-cutters of the Tyrol, who work exceedingly hard and with great expenditure of strength, accordingly consume an immense amount of food abounding in carbon in addition to a certain quantity of nitrogenous matter. They live almost exclusively on flour and butter. Only on one day in the week, Sunday, do they eat meat and drink beer. For six days they are limited to whatever they carry into the forests with them. The nature of the food may, therefore, be very accurately regulated in this case. Their power of enduring very great toil is principally due to the large amount of fat contained in their daily food. Chamois hunters and other mountaineers take chiefly bacon and sugar by way of provision on their laborious expeditions. Experience has taught them that these highly carboniferous compounds are especially suited to enable them to accomplish great labour. Sugar is especially suitable for the purpose, because, being very readily soluble, it

passes rapidly into the blood, and is, therefore, especially capable of rapidly replacing the expended forces. It is not suitable for a sole or main food material during long periods, because when a great quantity of sugar is introduced into the stomach it is transformed into lactic acid and the digestion is injured.

5. When muscles have lain by for some time after their extraction from the body, a change occurs in them which deprives them of their capacity for contracting when irritated. This change intervenes yet more rapidly when they are induced to pass into a state of activity by many repeated irritations. The time necessary for the intervention of this change varies much, and depends chiefly on the nature of the animal and on the temperature. The muscles of mammals in a temperature such as that of an ordinary room lose their power of contraction in as little as from twenty to thirty minutes; the muscles of frogs do not lose this power for several hours, and some from the calf-muscle of a frog have been observed to pulsate even for forty-eight hours in the temperature of an ordinary room. At a temperature of from  $0^{\circ}$  to  $1^{\circ}$  C. the same muscle may retain its power of contraction even for eight days. On the other hand, in a temperature of, or above,  $45^{\circ}$ , the contractile power is lost in a few minutes. Exactly the same happens in muscles yet remaining within the body of the animal if the blood-current ceases to pass through the body, either because of the death of the animal, or in consequence of the local application of ligatures to the vessels. This loss of contractile power is spoken of as the *death* of the muscle. Muscular death does not, therefore, correspond in time with the general death of the whole animal, but it follows this

general death at a period varying from thirty minutes to several hours.

6. On looking at the dead muscle of a frog it will be noticed that its appearance differs essentially from that of a fresh muscle. It does not appear so transparent, is much duller and whiter in colour; at the same time it feels harder, less elastic, but is capable of greater extension, and, finally, it is tender and easily torn apart, the more so the further the change has proceeded. Exactly similar changes affect the muscles of a dead body. This is called the *death-stiffening* (*rigor mortis*). E. du Bois-Reymond showed that on the occurrence of this death-stiffening the original alkaline or neutral reaction gives place to an acid reaction. This is probably due to the transformation of the neutral glycogen and inosit into lactic acid, which with the alkalis present forms acid-reacting salts. This change is the cause of the fact that butcher's meat, which remains hard and tough if it is cooked directly after death, becomes gradually more tender. If the meat is allowed to lie for a time after death, the death-stiffening again relaxes, the separate bundles of fibres no longer adhere so firmly to each other; and when in this condition the meat is better adapted for preparation as food, because it is tender and may be more easily chewed, and because it offers less resistance to the digestive juices.

The death-stiffening in its chemical nature, therefore, bears a certain resemblance to the changes which occur during the activity of the muscle. In the latter case also an acid is formed, which is, however, again eliminated and carried away by the blood. In the death-stiffening this elimination cannot occur, the circulation of the blood having ceased. For this reason death-



stiffening intervenes much more quickly in muscles which have been strongly irritated before death, as for instance in those of hunted animals. But while the formation of acid must always be very slight in active muscle, it increases greatly in muscles which have undergone death-stiffening, and the acid acts as a relaxing agent on the connective tissue which holds the fibres together, so that the latter separate more readily. At the same time, however, another distinct change occurs within the muscle-fibre. If a fresh living muscle-fibre and one that has undergone death-stiffening are examined under the microscope, the latter appears dull and opaque; the transverse striations are narrower and approach more nearly together, and the contents are not active and fluid, as in the living fibre, but are fixed and broken into fragments. When unextended muscles undergo death-stiffening, they usually become shorter and thicker. In the mobile facial muscles of a dead body the result of this is that the lines, which immediately after death were relaxed, again acquire a certain expression. The death-stiffening of the muscles is the cause of a certain rigidity in the limbs of corpses, so that the limbs are retained in the same relative position in which they were at death; and it is to this circumstance that the name 'death-stiffening' (*rigor mortis*) is principally due. Moreover, this change does not occur simultaneously in the muscles of all parts of the dead body; it usually begins in the muscles of the face and neck and passes gradually downward, so that the muscles of the legs are the last to be affected by it. The relaxation of the rigidity takes place in the same order.

On account of the shortening undergone by muscles

during death-stiffness it was formerly believed that the latter was to be regarded as a true contraction, as a last exertion of muscular force in which the muscle took leave of its peculiar capacity. There is, however, nothing to show that this shortening which takes place at death, and which may moreover be hindered by the application of even a slight weight, corresponds in any way with the real state of activity. All the phenomena of muscular rigidity are, indeed, more fully explained by the assumption that some constituent part of the muscle which is liquid in the living muscle becomes fixed or coagulates. Death-stiffening would accordingly be a process analogous to the coagulation of the blood, which after death or after it has been allowed to escape from the blood-vessels becomes firm, in consequence of the fact that one of its constituents, the blood fibrous matter, or fibrine, secretes itself as a solid. This view of death-stiffness was first expressed by E. Brücke and was afterward confirmed by Kühne. If the muscles of a frog are freed from all blood by injection with an innocuous fluid, such as a weak solution of common salt, and are then pressed, a fluid is obtained which represents part of the liquid contents of the muscle-fibres. If this fluid is allowed to stand for some hours in the ordinary temperature of a room, a flaky clot forms in it at the same period at which other muscles of the same animal undergo death-stiffening. The expressed muscle-fluid is originally quite neutral; but while the clot is forming it becomes continually more acid. The resemblance of the process in this muscle-fluid to that in the muscle itself is, therefore, such as to justify the assumption that at the same time a coagulation, simultaneously with an acid-formation, takes place within the muscle

itself, and that this coagulation represents the essential fact in death-stiffening.

Death-stiffening intervenes, as we found, earlier in proportion as the temperature is higher. Exactly the same is the case in expressed muscle-fluid. If it is heated to a temperature of  $45^{\circ}$  C. it coagulates in a few minutes, becoming acid at the same time. Muscles also, if they are heated to a temperature of  $45^{\circ}$  C., undergo death-stiffening in a few minutes. If they are still further heated, up to or above a temperature of  $73^{\circ}$  C., they contract into shapeless lumps, become quite hard and white, and exhibit a firm solid tissue resembling the white of eggs when cooked. From this it may be inferred that, besides the matter which coagulates during the death-stiffening, other soluble albuminous bodies are also present in muscle, and that these act as ordinary albumen as it occurs in blood and in eggs; for the latter also coagulates when heated to  $73^{\circ}$  C. It therefore appears that various kinds of albumen occur in muscle. That which coagulates at  $45^{\circ}$ , or, though somewhat more slowly, in the ordinary temperature of a room, is called myosin. It may be assumed that this albuminous body is naturally soluble, but that it is rendered insoluble by the acids occurring within the muscle. Death-stiffening would accordingly be the result of the formation of acid. Our knowledge on this point is, however, yet very incomplete, and must remain so until chemistry has afforded more full explanation of the nature of albuminous bodies.



## CHAPTER VI.

1. Forms of muscle ; 2. Attachment of muscles to the bones ; 3. Elastic tension ; 4. Smooth muscle-fibres ; 5. Peristaltic motion ; 6. Voluntary and involuntary motion.

1. In examining the action of muscle in the previous chapters we have invariably dealt with an imaginary muscle the fibres of which were of equal length and parallel to each other. Such muscles do really exist, but they are rare. When such a muscle shortens, each of its fibres acts exactly as do all the others, and the whole action of the muscle is simply the sum of the separate actions of all the fibres. As a rule, however, the structure of muscles is not so simple. According to the form and the arrangement of the fibres, anatomists distinguish short, long, and flat muscles. The last-mentioned generally exhibit deviations from the ordinary parallel arrangement of the fibres. Either the fibres proceed at one end from a broad tendon, and are directed towards one point from which a short round tendon then effects their attachment to the bones (fan-shaped muscles); or the fibres are attached at an angle to a long tendon, from which they all branch off in one direction (semi-pennate muscles), or in two directions like the plumes of a feather (pennate muscles). In the radiate or fan-shaped muscles the pull of the separate parts takes effect in different directions. Each of these

parts may act separately, or all may work together; and in the latter case they combine their forces, as is invariably the case with forces acting in different directions, in accordance with the so-called parallelogram of forces. As an example of this sort of muscle the elevator of the upper arm—which was before alluded to in the second chapter, and which on account of its triangular shape is called the deltoid muscle—may be examined. Contractions of the separate parts really occur in this. When only the front section of the muscle contracts, the arm is raised and advanced in the shoulder socket; when only the posterior part of the muscle contracts, the arm is raised backward. When, however, all the fibres of the muscle act in unison, the action of all the separable forces of tension constitute a diagonal which results in the lifting of the arm in the plane of its usual position.

In some semi-pennate and pennate muscles the line of union of the two points of attachment does not coincide with the direction of the fibres. When the muscle contracts each fibre exerts a force of tension in the direction of its contraction. All these numerous forces, however, produce a single force which acts in the direction in which the movement is really accomplished, and the whole action of the muscle is the sum of these separate components, each derived from a single fibre. In order to calculate the force which one of these muscles can exert, as well as the height of elevation proper to it, it would be necessary to determine the number of the fibres, the angle which each of these makes, with the direction finally taken by the compound action, as well as the length of the fibres—these not being always equal. This task if only carried out in the case of a single muscle would be a very great test of patience. Fortu-

nately no such tedious calculations are requisite for our purpose. The force may be directly determined by experiment in the case of many muscles, by the method already described in Chapter IV. § 6; the height of elevation possible under the conditions present in the body may be yet more easily found; and as regards the work which the muscle is able to perform, it makes no difference whether the fibres are all parallel and act in their own direction, or if they form any angle with the direction of work.<sup>1</sup>

2. The direction in which the action takes effect does not, however, depend only on the structure of the muscle, but chiefly on the nature of its attachment to the bone. Owing to the form of the bones and their sockets, the points of connection by which the bones are held together, the bones are capable of moving only within certain limits, and usually only in certain directions. For instance, let us watch a true hinge-socket, such as that of the elbow, which admits only of bending and stretching (*cf.* ch. ii. § 4). As in this case, the nature of the socket is such that motion is only possible in one plane, the muscles which do not lie in this plane can only bring into action a portion of their power of tension, and this may be found if the tension exercised by the muscle is analysed in accordance with the law of the parallelogram of forces, so as to find such of the component forces as lie within the plane.

It is different in the case of the more free ball-sockets, which permit movement of the bone in any direction within certain limits. When a socket of this sort is surrounded by many muscles, each of the latter, if it acts alone, sets the bone in motion in the direction

<sup>1</sup> See Notes and Additions, No 2.



of its own action. If two or more of the muscles assume a state of activity at the same time, then the action will be the resultant of the separate tensions of each, and this may also be found by the law of the parallelogram of forces.

There is yet another way in which the work performed by the muscles is conditioned by their attachment to the bones. The latter must be regarded as levers which turn on axes, afforded by the sockets. They usually represent one-armed, but sometimes two-armed levers. Now, the direction of the tension of the muscles is seldom at right angles to that of the moveable bone lever, but is usually at an acute angle. In this case, again, the whole tension of the muscle does not take effect, but only a component, which is at right angles to the arm of the lever. Now, it is noticeable that in many cases the bones have projections or protrusions at the point of the attachment of the muscles, over which the muscle tendon passes, as over a reel, thus grasping the bone at a favourable angle; or, in other cases, it is found that cartilaginous or bony thickenings exist in the tendon itself (so-called sesamoid bones), which act in the same way. The largest of these sesamoid bones is that in the knee, which, inserted in the powerful tendon of the front muscle of the upper thigh, gives a more favourable direction to the attachment of this tendon than there would otherwise be.

Sometimes the tendon of a muscle passes over an actual reel, so that the direction in which the muscle-fibres contract is entirely different from that in which their force of tension acts.

3. The last important consequence of the attach-

ment of the muscles to the bones is the extension thus effected. If the limb of a dead body is placed in the position which it ordinarily occupied during life, and if one end of a muscle is then separated from its point of attachment, it draws itself back and becomes shorter. The same thing happens during life, as is observable in the operation of cutting the tendons, as practised by surgeons to cure curvatures. The result being the same during life and after death, this phenomenon is evidently due to the action of elasticity. It thus appears that the muscles are stretched by reason of their attachment to the skeleton, and that, on account of their elasticity, they are continually striving to shorten. Now, when several muscles are attached to one bone in such a way that they pull in opposite directions, the bone must assume a position in which the tension of all the muscles is balanced, and all these tensions must combine to press together the socketed parts with a certain force, thus evidently contributing to the strength of the socket connection. When one of these muscles contracts, it moves the bone in the direction of its own tension, but in so doing it extends the muscle which acts in an opposite direction, and the latter, because of its elasticity, offers resistance to the tension exerted by the first muscle, so that as soon as the contraction of the latter is relaxed the limb falls back again into its original position. This balanced position of all the limbs, which thus depends on the elasticity of the muscles, may be observed during sleep, for then all active muscular action ceases. It will be observed that the limbs are then generally slightly bent, so that they form very obtuse angles to each other.

Not all muscles are, however, extended between

bones. The tendons of some pass into soft structures, such as the muscles of the face. In this case also the different muscles exercise a mutual power of extension, though it is but slight, and they thus effect a definite balanced position of the soft parts, as may be observed in the position of the mouth-opening in the face. If the tension of the muscles ranged on both sides is not equal, the mouth opening assumes a crooked position. This happens, for example, when the muscles of one half of the face are injured; and it thus appears that in this case the elastic tension is too weak to allow of the retention of the normal position of the mouth.

In muscles attached to bones the elastic tension is, however, much greater, a circumstance which naturally exercises an influence on their action during contraction.

4. As yet attention has only been paid to one kind of muscle-fibre, that which from the very first we distinguished as striated fibre. There is, however, as we have seen, another kind, the so-called *smooth muscle-fibre*. These are long spindle-shaped cells, the ends of which are frequently spirally twisted, and in the centre of which exists a long rod-shaped kernel or nucleus. Unlike striated muscle, they do not form separate muscular masses, but occur scattered, or arranged in more or less dense layers or strata, in almost all organs.<sup>1</sup> Arranged in regular order, they very frequently form widely extending membranes, especially in such tube-shaped structures as the blood-vessels, the intestine,

<sup>1</sup> An instance of a considerable accumulation of smooth muscle-fibres is afforded by the muscle-pouch of birds, which, with the exception of the outer and inner skin coverings, consists solely of these fibres collected in extensive layers.



&c., the walls of which are composed of these smooth muscle-fibres. In such cases they are usually arranged in two layers, one of which consists of ring-shaped fibres surrounding the tube, while the other consists of fibres arranged parallel to the tube. When, therefore, these muscle-fibres contract, they are able both to reduce



FIG. 25. SMOOTH MUSCLE-FIBRES (300 TIMES ENLARGED).

the circumference, and to shorten the length of the walls of the tube in which they occur. This is of great importance in the case of the smaller arteries, in which the smooth muscle-fibres, arranged in the form of a ring, are able greatly to contract, or even entirely to close the vessels, thus regulating the current of blood through the capillaries. In other cases, as in the intestine, they serve to set the contents of the tubes in motion. In the latter cases the contraction does not

take place simultaneously throughout the length of the tube ; but, commencing at one point, it continually propagates itself along fresh lengths of the tube, so that the contents are slowly driven forward. The principal agents in this are the circularly arranged fibres, which at one point completely close the tube, while, by the contraction of the longitudinal fibres, the wall of the tube is drawn back over its contents, thus providing for the propulsion of the contents. This is called *peristaltic motion*. It takes place along the whole of the digestive canal, from the throat to the other end, and in this case affects the forward motion of the food, as also, finally, the expulsion of the undigested residue.

5. Peristaltic motion may be very well observed by laying bare the throat of a dog, and then placing water in the mouth of the animal, so that the motion of swallowing takes place. It may also be seen in the intestines when laid bare, as also in the urinary duct, in which each drop of urine leaving the kidneys produces a wave which propagates itself from the kidneys to the urinary bladder. Such movements may also be artificially elicited by mechanically or electrically irritating some one point of the intestine, urinary duct, or other such part, or by irritating the nerves appropriate to these parts. The most striking feature is the slowness with which these motions take place. Not only does a long time, observable without any artificial aid, elapse after the application of the irritant before the motion begins, but, even if the irritation is sudden and instantaneous, the motion excited at one point passes along very gradually, slowly increasing up to a definite point, and then again gradually decreasing. This slowness of motion essentially distinguishes smooth from

striated muscle-fibres. But, as we know, this is not a distinction of kind, but only one of degree; for we found that in the case of striated muscle also there is a stage of latent irritation, then a gradually increasing, and then again a gradually decreasing contraction. But that which in striated muscle occupies but a few parts of a second, in smooth muscle-fibres occupies a period of several seconds. No artificial aid is, therefore, required in this case to distinguish the separate stages. At present, research into the nature of smooth muscle-fibre has not resulted in the acquirement of more than this somewhat superficial knowledge. Owing especially to the difficulty of isolating the fibres, and to the rapidity with which they lose their irritability when separated from the body, it is very difficult to experiment with them. It is especially not yet clear by what means the transference of the irritation arising at one point to the other part is effected. The transference never occurs in the case of striated muscle. If a long, thin, parallel-fibred muscle is separated out on a glass plate, and a very small part of it is then irritated, the irritation immediately propagates itself in a longitudinal direction in the muscle-fibre immediately touched. It is impossible to produce contraction in a striated muscle-fibre only at one point in its length, at least while the muscle-fibre is fresh. In dying muscle-fibres such local contractions do indeed occur. Each separate muscle-fibre, therefore, forms a closed whole in which the contraction excited at one point spreads over the whole fibre. The speed with which it spreads within the fibre has even been measured. As the striated muscle-fibre in contracting becomes also thicker, a small light lever, if attached to the fibre, is somewhat raised,



and this rise can be indicated on a rapidly-moving myograph plate. If two of these small levers are placed near the ends of a long muscle, and one of the ends is then irritated, the nearer lever is first raised, the more remote not till later. This difference may be read off the plate of the myograph, and thus the speed of the propagation from one lever to the other may be calculated. Aeby, who first tried this experiment, found that the speed was from one to two metres in the second, or, in other words, that a contraction excited at one point of a muscle-fibre requires a period of from about  $\frac{1}{200}$  to  $\frac{1}{100}$  of a second to advance one centimetre. More recent measurements by Bernstein and Hermann show the higher value of from three to four metres in the second. On the death of the muscle, the rate of propagation becomes continually less, finally ceasing entirely in muscles which are just about to pass into a state of death-stiffness, so that on irritation only a slight thickening is seen at the point directly irritated, and this does not propagate itself. Under all circumstances, however, the excited contraction is confined to the fibres which are themselves actually irritated, the neighbouring fibres remaining perfectly quiescent. In smooth muscle-fibres, however, it is found that the contractions excited at one point propagate themselves in the adjacent fibres also. The marked distinction which thus appears to exist between smooth and striated muscles would, it is true, disappear if the views of Engelmann, resulting from his study of the urinary duct, are confirmed. According to that writer, the muscular mass of the urinary duct does not consist during life of separate muscle-fibre cells, but forms a homogeneous connected mass which only separates

into spindle-shaped cells at death. If this view could also be extended to the smooth muscle masses of other parts, a real connection would exist throughout the muscle-membranes, and the phenomena of the propagation<sup>2</sup> of irritation would admit of a physiological explanation.

6. As a rule, such parts as are provided only with smooth muscle-fibres are not voluntarily movable, while striated muscle-fibres are subject to the will. The latter have, therefore, been also distinguished as voluntary, the former as involuntary muscles. The heart, however, exhibits an exception, for, though it is provided with striated muscle-fibres, the will has no direct influence upon it, its motions being exerted and regulated independently of the will.<sup>1</sup> Moreover, the muscle-fibres of the heart are peculiar in that they are destitute of sarcolemma, the naked muscle-fibres directly touching each other. This is so far interesting that direct irritations, if applied to some point of the heart, are transferred to all the other muscle-fibres. In addition to this, the muscle-fibres of the heart are branched, but such branched fibres occur also in other places, for example, in the tongue of the frog, where they are branched like a tree. Smooth muscle-fibres being, therefore, not subject to the will, are caused to contract, either by local irritation, such as the pressure of the matter contained within the tubes, or by the nervous system. The contractions of striated muscle-fibres are effected, in the natural course of organic life, only by the influence of

<sup>1</sup> Striated muscles also occur in the intestine of the tench (*Tinca vulgaris*), which in this differs from all other vertebrate animals. It is doubtful whether this tissue is capable of voluntary motion, but it is very improbable

the nerves. We must now, therefore, examine the characters of nerves, after which we shall try to explain the nature of their influence on muscles.

It must also be observed that the distinction between striated and smooth muscle-fibres is not absolute; for there are transitional forms, such as the muscles of molluscs. The latter consist of fibres, exhibiting to some extent a striated character, and, in addition to this, the character of double refraction. At these points the disdiaclasts are probably arranged regularly and in large groups, while at other points (as in true smooth muscle-fibres) they are irregularly scattered and are therefore not noticeable.



## CHAPTER VII.

1. Nerve-fibres and nerve-cells; 2. Irritability of nerve-fibre;
3. Transmission of the irritation; 4. Isolated transmission;
5. Irritability; 6. The curve of irritability; 7. Exhaustion and recovery, death.

1. In the body of an animal nerves occur in two forms: either as separate delicate cords which divide into many parts and distribute themselves throughout the body, or collected in more considerable masses. The latter, at least in the higher animals, are enclosed in the bony cases of the skull and vertebral column, and are called *nerve-centres*, or *central organs of the nervous system*; the nerve-cords pass from these centres to the most distant parts, and are spoken of as the *peripheric nerve-system*. When examined under the microscope these peripheric nerves are seen to be bundles of extremely delicate fibres united into thicker bands within a membrane of connective tissue. Each of these nerve-fibres when examined in a fresh state, and enlarged 250 or 300 times, is exhibited as a pale yellow transparent fibre in which no further differentiation is visible. The appearance of the fibre soon, however, changes; it becomes less transparent, and a part lying along the axis becomes marked off from the circumference. This inner part is usually flat and band-like, and when seen under a higher power exhibits a very minute longitudinal

striation, as though it were formed of very delicate fibrillæ, or small fibres. It is called the *axis-band*, or *axis-cylinder*. The outer part has a crumpled appearance, and oozes at the cut ends of the nerve in drops which soon coagulate; it is called the *medullary*, or *marrow-sheath*. The medullary sheath entirely surrounds the axis-cylinder; as, however, when in a fresh,

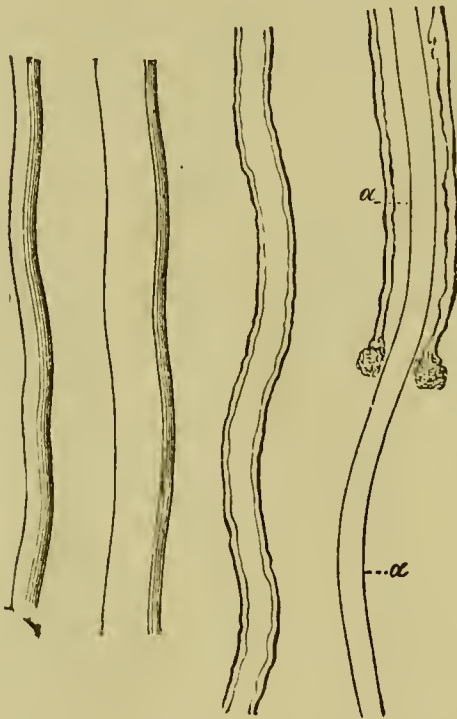

FIG. 26. NERVE-FIBRES.

*α α*, the axis-cylinder, still partially surrounded by the medullary sheath.

uncoagulated condition, it refracts light in exactly the same way as the axis-cylinder, it is undistinguishable from the latter, nor do the two become really separately visible till after the coagulation of the marrow. The medullary-sheath and the axis-cylinder are further enclosed in a tough elastic tube, which is called the *neurilemma* or *nerve-sheath*.

These three parts are not present in all peripheric nerves. Some of the latter have no medullary sheath, and are, therefore, axis-cylinders immediately surrounded by the nerve-sheaths. When many nerve-fibres are united into a bundle, these marrowless fibres are grey and more transparent, and are therefore sometimes called grey nerve-fibres. Those nerve-fibres which have medullary sheaths appear more yellowish white. If the nerves are traced to the periphery, more and more nerve-fibres are continually found to branch off from the common stem, so that the branches and branchlets

gradually become thinner. At last only separate fibres are to be seen, these being, however, still in appearance exactly like those constituting the main stem. Such fibres as up to this point have had medullary sheaths now frequently lose them, and therefore become exactly like grey fibres. The axis-cylinder itself then sometimes separates into smaller parts; so that a nerve-fibre, thin as it is, embraces a very large surface. The ends of the nerve-fibres are connected sometimes with muscles, sometimes with glands, and sometimes, again, with peculiar terminal organs.

In the central organs of the nervous system many nerve-fibres are found which are in appearance indistinguishable from those of the peripheric system. There are fibres with axis-cylinder, medullary sheath, and neurilemma, others without medullary sheath, and, finally, others in which no neurilemma can be detected, and which may therefore be described as naked axis-cylinders. But, besides these, very delicate fibres, far finer than the axis-cylinders, occur. The central organs of the nervous system are however especially marked by the abundant occurrence of a second element, which, though it is not altogether unrepresented in peripheric nerves, yet is only found in the latter distributed in a few places, whilst in the central organs it constitutes an important portion of the whole mass. This consists of certain cell-like structures called *nerve-cells*, or *ganglion-cells*. In each ganglion-cell it is possible to distinguish the cell body, and a large kernel (*nucleus*) within this; within the kernel, a smaller kernel (*nucleolus*) may also frequently be distinguished. Some ganglion-cells are also surrounded by a membrane which occasionally passes into the neurilemma of



nerve-fibres, which are connected with the cell. The kernel is finely granulated and is composed of a

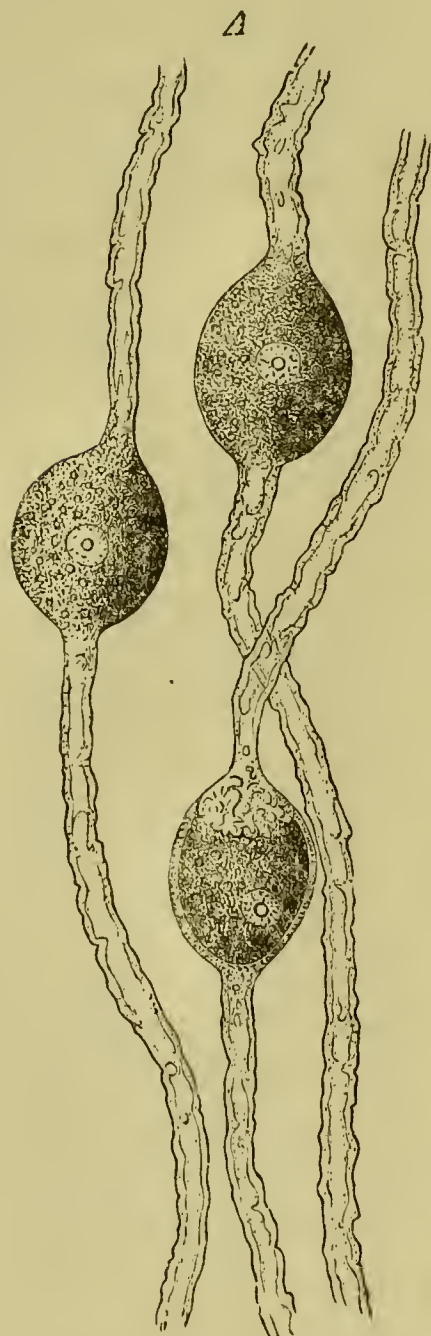

FIG. 27. GANGLION-CELLS WITH NERVE-PROCESSES.

protoplasmic mass, which, when heated, or subjected to certain other influences, becomes dull and opaque, but which in a fresh condition is usually somewhat transparent. The form of the ganglion-cells is very variable. Sometimes they appear almost globular; in other cases they are elliptic; others, again, are irregular, provided with numerous offshoots. Most ganglion-cells have one or more projecting processes; some are, indeed, found without processes, but it is certain that this condition is merely artificially produced, the processes having been torn off during the preparation of the ganglion-cell. Ganglion-cells are occasionally inserted in the course of the nerve-fibres, so that the processes differ in no way from other nerve-fibres, as is shown in fig. 27. In the ganglion-cells of the dorsal marrow, which have many processes, some of these appear exactly like the rest of the cell body—

that is to say, they are finely granulated; these are called protoplasmic processes. On the other hand, in

almost every cell a process may be distinguished which is altogether distinct in appearance from the rest. The protoplasmic processes become gradually finer and separate into more parts, and the processes of neighbouring cells are partly connected together. But the one process which is distinguishable from the rest passes along for a certain distance as a cylindrical cord, and then, suddenly becoming thicker, it encases itself in a medullary sheath, and in appearance entirely resembles the medullary fibres of the peripheric system. It is extremely probable, although it is hard to prove it with certainty, that a fibre of this sort passing out of the dorsal marrow is directly transformed into a peripheric nerve-fibre, while the protoplasmic processes continuing on their course within the central organ serve to connect the ganglion-cells.

The nerve-system, the main parts of which we have thus roughly examined, effects the motions and sensations of the body. These qualities belong, however, mainly to the central parts, in which ganglion-cells occur. The peripheric nerve-fibres act merely as conducting or transmitting apparatus to or from the central organs. Before examining the peculiar action of the central nervous system, it is desirable to devote some attention to this conducting apparatus and to discover its nature.

2. On exposing one of the peripheric nerves of a living animal and allowing irritants to act upon this, in the way which was described in the case of muscles, two effects are usually observable. The animal suffers pain, which it expresses by violent motion or cries, and, at the same time, individual muscles contract. On tracing the irritated nerve to the periphery, it will be

found that certain of its fibres unite with those muscles which pulsated. We already know that the other end of the nerve is connected with the nerve-centre. If the nerve is cut at a point between the irritated spot and the nerve-centre, the muscular pulsation occurs as before on the re-application of the irritant, but the sensation of pain is absent. If, on the other hand, the nerve is cut at a point nearer the periphery, no muscular pulsation results from irritation, but pain is felt. It thus appears that the peripheric nerves, when irritated at any point in their course, are able to cause effects both at their central and peripheric ends, provided that the conductive power of the nerves remains uninjured in both directions. This enables us to study more closely the action of the nerves on the muscles, by extracting and preparing a portion of the nerve with its muscle, in an uninjured condition, and then subjecting this nerve to further research.

That a nerve is irritable, in the same sense as we found that the muscle was, is already shown by these preliminary experiments. But while it was possible to observe the effects of the irritation on the muscle directly, the nerve does not exhibit any immediate change, either in form or appearance. Even under the strongest microscopic power nothing is discernible, and it would be impossible to know if a nerve is in any way irritable if the muscle which occurs at one end of it did not show by its pulsation that some change must have occurred within the nerve. The muscle is therefore used as a re-agent to test the changes in the nerve itself. The requisite experiments may be either with warm-blooded or with cold-blooded animals. As, however, the muscles of warm-blooded animals, when with-



Drawn from the influence of the circulation of the blood, soon lose their power of activity, the nerves and muscles of frogs are preferable for these experiments. The lower part of the thigh of a frog, with a long portion of the sciatic nerve, which is very easily separable up to the point where it emerges from the vertebral column, is best suited for this purpose. In some cases it is better to use only the calf-muscle with the sciatic nerve; the muscle must be fastened in the same way as in the former experiments, and its contractions must be made evident by use of a lever.

If the muscle, thus fastened, is pinched at any point in its course it pulsates. The same result follows if a thread is passed round the nerve, and the latter is thus constricted, or if a small piece is cut from the nerve with a pair of scissors. These are mechanical irritants which act on the nerve. Pulsation will, however, also be seen if the nerve is smeared with alkaline matter, or acid—these are chemical irritants. A portion of the nerve may be heated; that is, it may be thermically irritated. In all these cases, the nerve at the point irritated, immediately, or, at least very soon, loses its capacity for receiving irritation. But if the nerve is placed on two wires, by means of which an electric current is passed through one point in the nerve, it may, in this way, be repeatedly electrically irritated without its irritability being immediately destroyed. It therefore appears that, in this respect, a nerve acts exactly as does a muscle. If a constant electric current is applied, the result is usually a pulsation on the closing and the opening of the current, but sometimes a lasting contraction ensues while the current flows through the portion of the nerve. If

inductive shocks are applied, each separate shock produces a muscular pulsation, and if many separate inductive shocks are applied to the nerve, the muscle passes into a state of tetanus. These inductive shocks must be applied to the nerve at some distance from the muscle. Each inductive shock induces a muscular pulsation. On cutting the nerve with a pair of scissors, between the point irritated and the muscle, all influence upon the muscle ceases. It is useless to place two cut surfaces together, even with the greatest care; they may adhere, and the nerve, when superficially examined, may appear uninjured, but irritants applied above the point of section cannot act through the nerve upon the muscle. The same thing occurs if a thread, passed round the nerve, is drawn tight between the point irritated and the muscle. The thread may be removed, but the crushed spot proves an impassable barrier to all influence on the muscle. If, however, the wires are moved and the inductive currents are applied to another point below the cut or the constriction, the action at once recommences.

3. The conclusion to be drawn from these experiments is, either that the nerve, even if only a small portion of it is irritated, passes at once into an active condition throughout its entire length as far as the muscle, or that the irritant acts directly only on the spot immediately irritated, and that the activity which is excited in the nerve at this point propagates itself along the fibres until it reaches the muscle in which it causes a contraction. If the latter view is correct, it must also be inferred that any injury to the nerve-fibre prevents the propagation of the activity in the latter; and it may also be deduced from the experiments with

the constricted nerves, that even if the nerve-sheath is in no way injured, the crushing of the contents of the nerve is in itself sufficient to prevent propagation of the activity. It can be shown that this latter view of the nature of the case is actually correct. For it is possible to determine the time which elapses between the irritation of the nerve and the commencement of muscular pulsation. For this purpose the same methods are applicable as we employed in the case of muscles. Electric measurement of time, or the myograph represented in fig. 17, may be used for this purpose. As however in the present case the point to be determined is, not the form of the muscle-curve, but the moment of its commencement, du Bois-Reymond simplified the apparatus so that the curve is drawn on a flat plate, which is pushed forward by spring power. Fig. 28 represents the apparatus. It stands on a strong cast-iron stand from which rise the two massive brass standards *A* and *B*. A light brass frame carries the indicating plate, which is of polished looking-glass, 160 mm. in length by 50 mm. in breadth. The frame runs with the least possible amount of friction on two parallel steel wires stretched between the standards. The distance between the standards is equal to twice the length of the frame, so that the whole length of the plate passes across the indicating pencil when the frame is pushed from standard to standard. Round steel rods are fastened to the short sides of the frame; and these rods in length somewhat exceed the path along which the frame passes, and they then pass, with as little friction as possible, through holes in the standards *A* and *B*. The end *b* of one of these rods is surrounded by a steel spring. By compressing this between the standard *B* and a knob on



the end of the rod, and thus driving the frame with the rods from *B* to *A*, in a direction opposite to that of the arrow on the indicating plate, a point is reached at which the 'trigger' which is seen on the standard *A*, and which acts upward, fits into a corresponding notch in the rod at *a*, thus preventing the re-extension of the spring. It therefore remains compressed till pressure

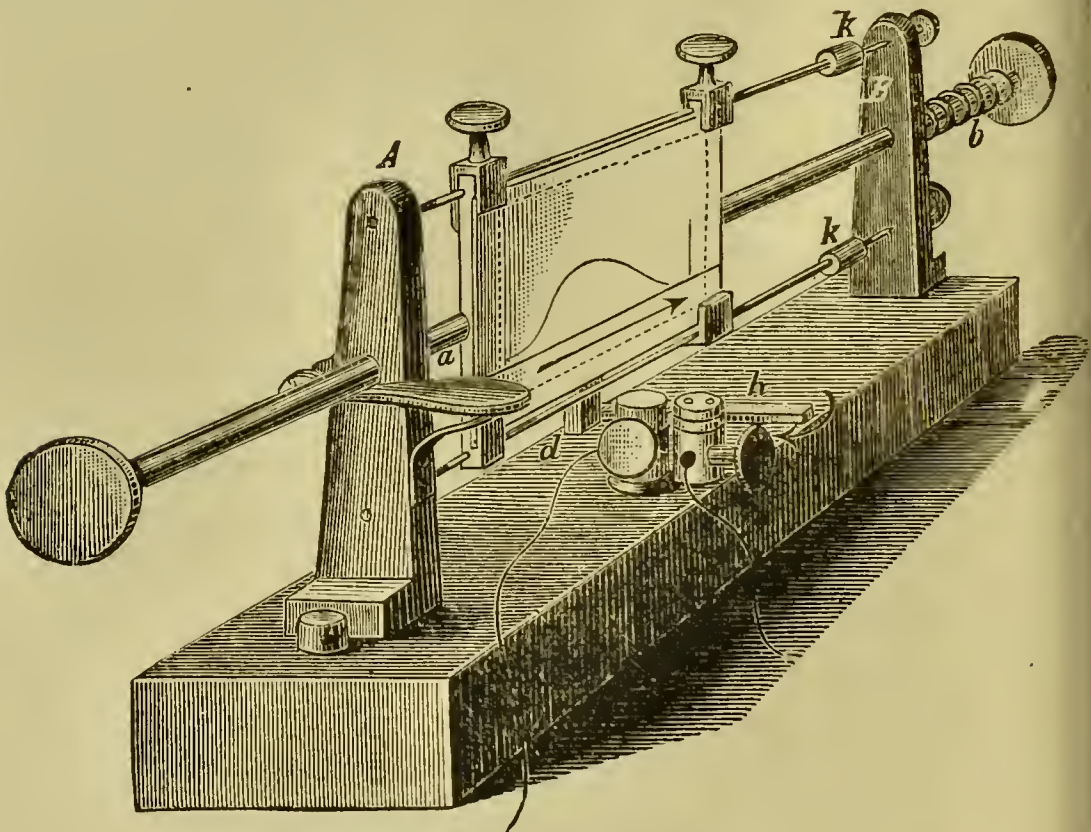

FIG. 28. SPRING MYOGRAPH, AS USED BY DU BOIS-REYMOND.

on the trigger frees the frame, which then traverses the whole length of the wires at a speed depending on the strength of the spring, &c., in the direction from *A* to *B*, that indicated by the arrow.

In order to describe the muscle-pulsation on this plate, side by side with it there is a lever with an indicating pencil, such as was used in the former experiment, to indicate the height of muscular elevation

and the elastic extension (see fig. 8, p. 26). This part is omitted in fig. 28, in order to make the indicating plate more visible. The rate at which the plate flies from *A* to *B* at first increases up to the point at which the spring exceeds the position in which it was when at rest. When the frame is in the position corresponding with this point, a projection *d*, which is situated on the lower edge of the frame, strikes the lever *h* and thus opens the main current of an inductorium, by which an inductive current is caused in the secondary coil of the inductorium; and this traverses and irritates the muscle. The result of this is that the muscle is irritated exactly at the moment at which the glass plate assumes a definite position relatively to the indicating pencil of the lever. If the glass plate is first pushed toward *A*, and is then slowly pushed toward *B*, until the projection *d* just touches the lever, and if the muscle is then caused to pulsate, the indicating pencil, being raised by the pulsation, describes a vertical line, the height of which represents the height of elevation of the muscle. If the glass plate is again brought back to *A*, and, by pressing the trigger, is then caused to fly suddenly and with great speed toward *B*, then the irritation of the muscle will occur when the glass plate is in exactly the same position, the indicating pencil standing exactly at the vertical stroke before described. The muscular pulsation thus produced will, however, in this case be indicated on the rapidly moving glass plate, with the result of giving, not a simple vertical stroke, but a curved line. The distance of the point of commencement from the vertical stroke expresses the latent irritation.

If, instead of irritating the muscle itself, a point

in the nerve is exposed to the irritation, the muscle in this case also describes the curve of its pulsation on the rapidly moved plate of the myograph. Arranging matters so that two curves of pulsation are allowed to describe themselves in immediate sequence, but with the difference that the nerve is irritated in one case at a point near the muscle, but in the other case at a point far from the muscle, two curves will be obtained on the plate of the myograph, which will appear exactly alike but yet will not cover each other. On the contrary, they are everywhere somewhat separated from each other, as is shown in figure 29.<sup>1</sup> In this

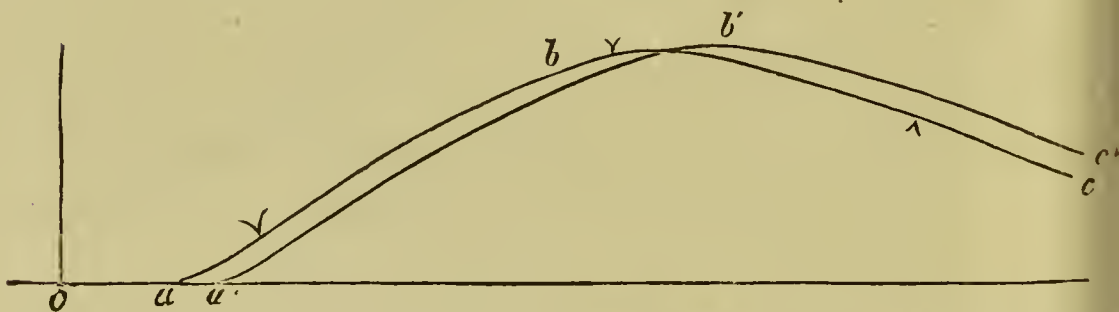

FIG. 29. PROPAGATION OF THE EXCITEMENT WITHIN NERVES.

figure, *abc* is the curve first described, on irritation of the nearer portion of the nerve; in order to distinguish it from the other it is marked by small nicks; *a'b'c'* represents the curve indicated immediately after the former, but obtained as the result of the irritation of a portion of the nerve remote from the muscle. The second curve is seen to be somewhat separated from the other; it does not commence so soon after the moment of irritation (which is indicated by the vertical stroke *o*); that is, a longer time elapsed between the moment of

<sup>1</sup> The curves in fig. 29 were described when the glass plate moved more rapidly, so that they appear more extended than those represented in figure 18.



irritation and the pulsation of the muscle in the latter case than in the former; and this difference evidently depends only on the fact that in the latter case the excitement within the nerve had to traverse a longer distance, and therefore reached the muscle later, so that the pulsation did not begin till later.

This time may be measured, if the rate at which the plate moved is known; or if simultaneously with the muscle-pulsation the vibrations of a tuning-fork are allowed to indicate themselves on the plate. From the time thus found and from the known distance between the two irritated points of the nerve, the rate at which the excitement propagates itself along the nerve may be calculated. Helmholtz, on the ground of his experiments with the nerves of frogs, found it to be about 24 m. per second. It is not, however, quite constant, but varies with the temperature, being greater in higher and less in lower temperatures. It has also been determined in the case of man. If the wires of the inductive apparatus are placed on the uninjured human skin, it is possible, as the skin is not an isolator, to excite the underlying nerves, especially where they are superficially situated. On thus irritating two points in the course of the same nerve, the resulting phenomena are exactly the same as those just observed in the case of the nerves of frogs. In order to determine the commencement of the muscle pulsation in the uninjured human muscle, a light lever is placed on the muscle in such a way that it is raised by the thickening of the latter. Experiments of this kind were made by Helmholtz with the muscles of the thumb. The appropriate nerve (*n. medianus*) may be irritated near the wrist and near the elbow. From the resulting difference

in time and from the distance between the two irritated points the rate of propagation of the excitement was found to be 30 m. per second. The high figure as compared with that found with the nerves of frogs is explained by the higher temperature of human nerves. The rate of propagation would indeed be much lowered if the temperature of the arm were considerably decreased by the use of ice.

The above calculation of the rate of propagation is made on the assumption that this rate is constant throughout its duration. There is, however, nothing to show that this is the case. On the contrary, it is more probable that the propagation proceeds at first at a greater and afterwards at a less speed. This may be inferred from an experiment arranged by H. Munk. If three pairs of wires are applied to a long nerve, one close to the muscle, another at the centre, and the third considerably above, and then causing three consecutive curves to describe themselves on the myograph plate by irritating these three points, it will be found that the three curves are not equally removed from each other; on the contrary, the first and second stand very near together, while the third is far from the two former. More than double the time was required for the excitement to traverse the full distance from the upper to the lower end than it took to traverse the half-distance from the middle of the nerve to its lower end. The simplest explanation which can be given of this phenomenon is that the excitement during its propagation is gradually retarded, just as a billiard ball moves at first very quickly but afterward at a gradually decreasing speed. The retardation of the billiard ball is due to the friction of the underlying surface. From

this it may be inferred that a resistance to the transmission exists within the nerve, and that this gradually retards the rate of propagation. Such a resistance to transmission is also probable on certain other grounds, to which subject we shall presently revert.

4. If the main stem of a nerve is irritated by electric shocks, all the fibres are invariably simultaneously irritated. On tracing the sciatic nerve to its point of escape from the vertebral column, it appears that it is there composed of four distinct branches, the so-called roots of the sciatic plexus. These rootlets may be separately irritated, and when this is done contractions result, which do not, however, affect the whole leg but only separate muscles, and different muscles according to which of the roots is irritated. Now as the fibres contained in the root afterward coalesce in the sciatic nerve within a membrane, it follows from the experiment just described that the irritation yet remains isolated in the separate fibres and is not imparted to the neighbouring fibres. This statement holds good of all peripheric nerves. Wherever it is possible to irritate separate fibres the irritation is always confined to these fibres and is not transmitted to those adjacent. We shall afterwards find that such transmissions from one fibre to another occur within the central organs of the nervous system. But in these cases it can be shown with great probability that the fibres not only lie side by side, but that they are in some way interconnected by their processes. In peripheric nerve-fibres the irritation always remains isolated. Their action is like that of electric wires enclosed in insulating sheaths. One of these nerves may indeed be compared to a bundle of telegraph wires, which are



protected from direct contact with each other by gutta-percha or by some other substance. The comparison is, however, but superficial. No electrically-isolating membrane can really be discovered in any part of the nerve-fibre, but all their parts conduct electricity. When, as we shall presently find, electric processes occur within the nerve, these standing in definite relation to the activity of the nerves, we must assume that isolation as it occurs in the nerves is not the same as in telegraph wires. We cannot here trace the matter further, but must accept the fact of isolated conduction as such, reserving its explanation for a future occasion.

5. On irritating the nerves by means of currents from an inductive apparatus, it is found that the pulsations which occur are sometimes strong, sometimes weak. All nerves are not alike in this respect, and even the parts of one and the same nerve are often very different. We must accordingly suppose that nerves are variable in the degree in which they receive irritation. This is spoken of as the *excitability* of the nerve, to express the greater or less ease with which they may be put in action by external irritation. Two ways may be adopted to measure the excitability of a nerve or of a certain point in a nerve. Either the same irritant may always be used, and the excitability may be determined by the strength of the muscular pulsation evoked by this irritant; or the irritant may be altered until it just suffices to evoke a muscular pulsation of a definite strength. In the former case it is evident that the excitability must be estimated as higher in proportion as the muscular pulsation produced by the irritant is stronger; in the latter case the excitability is said to be greater in proportion

as the irritant which is able to evoke a pulsation of definite strength is weaker. Each of these methods when practically applied has advantages and disadvantages. The former is capable of detecting very minute differences in the excitability, but it can only do this within certain narrow limits; for when the excitability sinks, the limit for a definite irritant is soon reached, after which no further pulsation at all results; and when the excitability rises, the muscle attains its maximum contraction, above which it is incapable of further contraction. Changes above or below either of these limits are, therefore, beyond observation so long as the irritant remains the same. The best way to apply the second method practically is to find that strength of irritant which exactly suffices to produce a just observable contraction of the muscle. This assumes the power of graduating the strength of the irritant at pleasure. If inductive currents are used to effect irritation, this graduation may be made with the greatest precision by altering the distance between the primary and secondary coils of the apparatus. In du Bois-Reymond's sliding inductive apparatus, represented in fig. 13, p. 35, the secondary coil is, therefore, attached to a slide which may be moved forward in a long groove. This arrangement is used in order to find the particular distance of the secondary coil from the primary which results in a just observable contraction of the muscle; and this distance, which can be measured by means of a scale divided into millimetres, is regarded as the measure of excitability.<sup>1</sup>

6. If a recently prepared nerve, as fresh as possible, is placed on a series of pairs of wires, and the excita-

<sup>1</sup> See Notes and Additions, No. 3.

bility at the various points of the nerve is consecutively determined in the way described above, it is generally found that the excitability of the upper part of the nerve is greater than that of the lower. There is, however, no great regularity in this character. Sometimes a point is found in the centre of the nerve which is less irritable than those immediately above and below it. Very frequently the most excitable point occurs, not immediately at the cut end, but at some little distance from this; so that, on proceeding downward, it is found to increase at first, and then, at a yet lower point, to decrease again. If such a nerve is observed for some little time, its excitability at the various points being tested every five minutes, it is found that the excitability alters especially soon at the upper end; it decreases, and in a short time is entirely extinguished, so that no muscular pulsations can afterwards be elicited from the upper parts even by the most powerful currents. The nerve is then said to be dead in its upper parts, and this death proceeds gradually downward in the nerve, so that pulsations can only be obtained by irritating the part situated nearest the muscle, and at a little later period even this part becomes dead. After the whole nerve is dead, pulsations may yet always be obtained for a time by direct irritation of the muscle. The muscle does not usually die until much later than the nerve. Yet in a quite fresh preparation of the nerve and muscle, the latter is always less excitable than the former, and a much stronger irritant is required to excite the muscle directly, than indirectly through the nerve. In all these experiments the nerve must be carefully protected from drying up, as otherwise its excita-



bility is very soon destroyed, and in a very irregular manner.

We have seen that the nerve dies gradually from the top downward. This death does not, however, consist in a simple falling off in the excitability from its original degree till it completely dies out. If the excitability is tested from time to time at a point some distance from the cut end, it is found to increase at first until it reaches a maximum, at which it remains for some time stationary, and it is not till after this that it gradually decreases and finally expires. The further the point experimented on is from the point which has been cut, the more slowly do all these changes occur; but their sequence is in all cases essentially alike. The explanation of this may be that the upper parts of the nerve, which directly after the preparation is made usually exhibit the highest degree of excitability, are really already changed. It must be assumed that these changes intervene very quickly at a point close to the section, so that it is impossible to submit these points to observation until they are already in the condition which does not intervene till later at the lower points—in the condition, that is, of increased excitability. This view is confirmed by the following experiment: if the excitability is determined at a lower point of the nerve, and the latter is then cut through above this point, the excitability increases at the point tested, and this takes place more quickly in proportion as the cut was made nearer to the tested spot. Each of the lower points may, therefore, be artificially brought under the same conditions under which only the upper parts of the nerve usually lie, that is, it may be arranged that they are near the

point of section. These changes in the excitability may, therefore, be thus conceived: that when the nerve is cut some influence makes itself felt from this cut, and that this first increases the excitability of the nerve, then decreases, and then extinguishes it. If this view is right, we must assume that the high degree of excitability of a freshly cut nerve is also only the result of the incision which is made. This is not, however, exactly the case. The nerve with the muscle of a living frog may be freed and prepared up to the vertebral column without separating it from the dorsal marrow. On irritating the various points in such a nerve, differences, slight indeed but yet observable, are noticed in the excitability, the upper parts being always more excitable than the lower. Uninjured human nerves may also, as we have seen, be irritated at various points in their course, and in this case also it is found that irritation is invariably more easily effective in the upper than in the lower parts.

Pflüger, who first called attention to the differences of excitability at the various points of the nerve, thought that the explanation of this is that the irritation evoked at one point in the nerve, in propagating itself along the nerve, gradually increases in strength; he spoke of it as an *avalanche-like increase in the excitement within the nerves*. This explanation appears to contradict the above-mentioned fact as to the effect of cutting on the nerve, for in such cases it appears that the irritation is strengthened by the cutting away of the higher portion of the nerve, even though the length of that portion of the nerve which is traversed by the irritation remains unaltered. It must at any rate be admitted that at one and the same point in the nerve

the excitability may vary in degree, and it is therefore simpler to assume that the difference in the results of irritating the nerve at various points depends directly on differences in the excitability at those points, instead of being in the first place dependent on changes caused by transmission; it can even be shown to be probable on various grounds, as indicated above, that the excitement in propagating itself through the nerve meets with resistance, and is therefore rather weakened than strengthened. Why the excitability differs in different parts of the same nerve we cannot explain. As long as we are ignorant of the inner mechanism of nerve-excitement, we must be satisfied to collect facts and to draw attention as far as may be to the connection of details, but we must decline to offer a full explanation of these.<sup>1</sup>

7. The phenomena of exhaustion and recovery may be exhibited in nerves as in muscles. If a single point in a nerve is frequently irritated, the actions become weaker after a time, and finally cease entirely. If the nerve is then allowed to rest for a time, new pulsations may again be elicited from the same point. It is not known whether this exhaustion and recovery corresponds with chemical changes in the nerve. We are almost entirely ignorant of the whole subject of chemical changes within the nerve. Some observers maintain that in the nerve, as in the muscle, an acid is set free during the active condition, but this is denied by others. The generation of warmth in the nerve during its activity has also been asserted, but this is also doubtful. If any chemical changes do take place within the nerve, they are extremely weak and

<sup>1</sup> See Notes and Additions, No. 4.



cannot be shown with our present appliances. As motions of the smallest particles (molecules) probably take place in the nerve, though the external form remains unaltered, and therefore no work worthy of consideration is accomplished, it is easily intelligible that these processes may be accompanied only by extremely slight changes in the constituent parts.

The speed with which death and the changes in excitability connected with death take place mainly depends, apart from the length of the nerve, on the temperature. The higher the temperature the more quickly does the nerve die. At a temperature of  $44^{\circ}$  C. death occurs in from ten to fifteen minutes; at  $75^{\circ}$  C. in a few seconds; and in the average temperature of a room the lower ends of a long sciatic nerve may retain their excitability for twenty-four hours or longer after extraction and preparation. Drying at first increases the excitability, but afterwards rapidly decreases it. Chemical agents, such as acids, alkalis and salts, destroy the excitability the more rapidly the more concentrated they are. In distilled water the nerve swells and rapidly becomes incapable of excitement. There are, therefore, certain densities of salt solutions in which the nerve remains excitable longer than in thinner or in more dense solutions. A solution of common salt of 0.6 to 1 per cent., for instance, has almost no effect on a nerve submerged in it, and preserves the excitability of this nerve about as long as damp air. Pure olive oil, if not acid, may also be regarded as innocuous. These are, therefore, used when the influence of different temperatures on the nerve is to be studied.

## CHAPTER VIII.

1. Electrotonus; 2. Modifications of excitability; 3. Law of pulsations; 4. Connection of electrotonus with excitability; 5. Transmission of excitability in electrotonus; 6. Explanation of the law of pulsations; 7. General law of nerve-excitement.

1. It has already been observed that a constant electric current, if transmitted through the nerve, is able to excite the latter; but that this exciting influence takes effect especially at the moment at which the current is closed and opened, and that it is less effective during the course of the current's duration. As yet it has been desirable for our purpose, that of studying the process of excitement in nerves, to make use of inductive currents, which are of such short duration that the closing and the opening, the beginning and the end, immediately follow each other in quick succession. Without now entering into the question, to be discussed later, as to why the exciting action of the current is less during the steady flow of the latter than at the moments of closing and opening, we will now examine whether the electric currents which traverse the nerves do not act on the nerves in some other way, distinct from their exciting influence.

Let us suppose that the current traverses either the whole or a portion of a nerve. At the instant at which the current in the nerve is closed, the appropriate muscle

pulsates, thus indicating that something, which we have called excitement, has occurred within the nerve. While, however, the current flows steadily through the nerve, the muscle remains perfectly quiescent, nor is any change apparent in the nerve itself. Yet it may easily be proved that the electric current has effected a complete change in the nerve, not only in that part traversed by the current, but also in the neighbouring parts above and below the portion of the nerve subjected to the electric current. The great importance of this lies in the fact that it reveals relations between the forces prevailing in the nerves and the processes of the electric currents, which relations are of great importance in the explanation of the activity of nerves.

Our knowledge of nerves has not as yet reached a point at which it is possible to understand all the changes which occur within them under the influence of electric currents. Indeed, but one set of these changes can as yet be described: these are the changes in the excitability. Of all the vital phenomena of nerves, their capacity of being brought into an active condition by irritants has at present alone been studied by us. This, as has been said in the previous chapter, may be quantitatively determined. Experiment shows that the excitability may be altered by electric currents. If a small portion of a nerve is placed on two wires in such a way that an electric current may be caused to traverse this portion, it appears that not only the portion actually traversed by the current, but the nerve beyond this, also suffers changes in its excitability. In order to study these, let us imagine several pairs of wires applied to the nerve  $n n'$  (fig. 30). Through one of these pairs of wires,  $c d$ , let a constant current be



conducted; by means of proper apparatus the current may be strengthened or weakened, and may be closed and interrupted by means of a key at *s*. Let a current from a sliding inductive apparatus pass through another portion of the nerve, e.g. *a b*, and let us find that position of the secondary coil at which the muscle exhibits marked pulsations of medium strength. The changes which occur in these pulsations when the current in the portion *c d* is alternately closed and interrupted

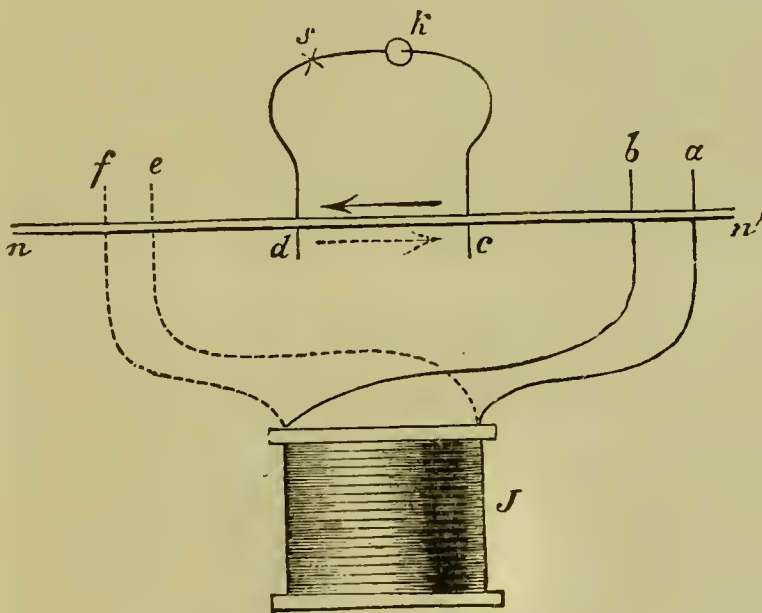

FIG. 30. ELECTROTONUS.

must now be observed. It is found that these changes depend on the direction of the current within the nerve. If the current passes in the direction from *c* to *d*, then the action of the same irritant is weakened in the portion *a b* as soon as the current is closed, but regains its former strength as soon as the current is interrupted. In this case, therefore, the excitability in the contiguous portion *a b* was lowered or hindered by the influence of the constant current traversing the portion *c d*. If, however, the constant current is reversed, so that it

passes from  $d$  to  $c$ , the influence of the irritant seems, on the contrary, to increase in  $a b$  when the current is closed, and to resume its original strength when the current is interrupted. In this case, therefore, it appears that the action of the current tends to increase the excitability. If the wires  $e f$  are next connected with the secondary coil of the inductive apparatus, and if the irritants are again applied in such a way that weak but noticeable pulsations occur, these latter are strengthened when the current in the portion  $c d$  passes from  $c$  to  $d$ ; and are, on the contrary, weakened when the current is in the opposite direction. In these two series of experiments the irritant was applied in one case above, in the other case below, the constant current. Both cases showed consistent results. As soon, that is, as the irritant acted on the side of the *positive electrode* or the *anode*, through which the current entered the nerve, the excitability was in both cases lowered. But when the irritant was applied on the side of the *negative electrode* or the *kathode*, through which the current emerged from the nerve, the irritant being strengthened, the excitability increased.

These changes in the excitability may be shown throughout the whole length of the nerve; but they are strongest in the immediate neighbourhood of the portion traversed by the constant current, gradually decreasing upward and downward from the electrodes. In order to find whether a change in the excitability also occurs within the electrodes, the current must be made to traverse a longer portion of the nerve, and the irritant must then be applied to a point within the electrodes. According to the point at which the electrode is applied, various changes may be shown to occur

here also. If the irritant is near the positive electrode, the excitability is lowered; near the negative electrode it is increased; and between the two occurs a point at which no noticeable change in the excitability takes place under the influence of the constant current.

From all these experiments we may infer that a nerve, one part of the length of which is traversed by a constant current, passes throughout its whole length into an altered condition, and that this is expressed in the excitability. One part of the nerve, that on the side of the positive electrode, exhibits decreased excitability; the part of the nerve corresponding with the negative electrode exhibits increased excitability. This altered condition is spoken of as the electrotonus of the nerve, the condition which exists on the side of the anode being distinguished as *anelectrotonus*; that on the side of the kathode as *katelectrotonus*. Where the anelectrotonus approaches the katelectrotonus, a point occurs between the electrodes at which the excitability remains unchanged; this is called the *neutral point*. The neutral point does not, however, always lie exactly between the electrodes; but its position depends on the strength of the applied currents. When the currents are weak, it lies nearer the anode; when they are stronger, it is situated nearer the kathode; and when the currents are of a certain medium strength, the neutral point is exactly midway between the two electrodes.

This electrotonic condition of the nerve may be exhibited as in fig. 31. In this  $n n'$  indicates the nerve,  $a$  and  $k$  the electrodes,  $a$  signifying the anode,  $k$  the kathode. The direction of the current within the nerve is, therefore, that indicated by the arrow. In order to



indicate the change which the excitability undergoes at any definite point in the nerve, let us suppose a straight line drawn at this point at right angles to the longitudinal direction of the nerve, and let this line be made longer in proportion as the change is greater. In order, moreover, to show that the changes which occur toward the anode are of an opposite tendency to those toward the kathode, let the line on the anode side be drawn downward, that on the kathode upward. By connecting together the heads of these lines a curve is obtained which diagrammatically represents the changes at each

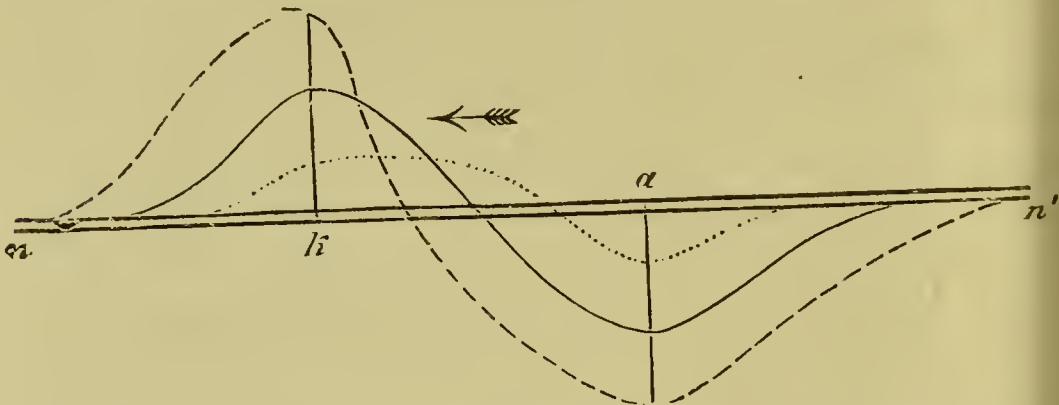

FIG. 31. ELECTROTONUS UNDER THE INFLUENCE OF CURRENTS OF VARYING STRENGTH.

point. Of the three curves, the middle represents the condition under the influence of a current of medium strength; the other two curves, indicated, the one by short lines, the other by a dotted line, represent the conditions under the influence of a strong and of a weak current respectively. These curves show that the changes are more marked in proportion as the current is stronger; that they are most strongly developed exactly at the electrode points; and, finally, that the neutral point, under the influence of currents of different degrees of strength, assumes a variable position between the electrodes.

2. Apart from these changes in the excitability which are thus observable while a continuous current passes through the nerve, others can also be shown to occur immediately after the opening of the current. Indeed, the excitability altered in electrotonus does not immediately revert to its normal value when the current is interrupted, but only regains this after the lapse of a short time. The duration of the changes in the excitability observable after the opening of the current is greater in proportion as the current is stronger and its duration is longer. These changes, which, to distinguish them from the electrotonic changes, are called *modifications* of the excitability, are not merely the continuance of an electrotonic condition, but are sometimes completely different from the latter. If, for instance, the experiment is tried at a point near the anode, at which the excitability is decreased during the continuance of the current, the excitability is found to be increased immediately after the opening of the current, and it is not till after this that the original normal excitability is regained. Similarly, in the neighbourhood of the kathode, the excitability decreases for a short time after the opening of the current, after which it again increases, and only gradually regains its normal condition. As a rule, these modifications do not last more than a few parts of a second. If, however, the constant current has been long present in the nerve, these modifications may endure for a somewhat longer period. On account of their transient nature it is difficult to observe and test them. The change of condition which follows the opening of the current within the nerve may, moreover, lead to excitement in the latter; so that, on the opening of a current which has been

present in the nerve for some time, a series of pulsations or an apparent tetanus is occasionally observed. This phenomenon has long been known as an opening tetanus, or as *Ritter's tetanus*. The connection existing between these changes in the excitability, and the fact that the nerve may be excited by electric currents, has led to the adoption of a view of the electric excitement in nerves which we shall not be able to develop until we have more closely studied electric excitement itself.

3. If a continuous current is passed through a nerve, and is alternately closed and opened, the excitement appears to occur irregularly, sometimes at the closing, sometimes at the opening of the current, and occasionally even at both. Closer observation has, however, shown that very definite laws control this, provided that attention is paid to the strength of the current and its direction within the nerve. Let us first examine these phenomena as they occur in fresh nerve, and, as we found that the conditions in the nerve change very rapidly in the neighbourhood of the cut end, let us commence our observations at a low point in a fresh nerve, of which as great a length as possible has been extracted. For this purpose it is especially necessary to possess a convenient means of graduating at will the strength of the applied currents. Various methods have been used for this purpose. The best is that which is based on the distribution of the currents in branching conductors. The electric current, on being made to traverse a conductor which separates at any point into two branches, divides, the strength of the currents distributed into these two branches not being always equal, but being in each branch in inverse ratio to the resistance offered in that branch. Supposing that the nerve



is inserted in one branch, and that the resistance of the other branch is altered, then the strength of the current passing through the nerve will change, although the conductor which contains the nerve remains unaltered; the current within the nerve will increase in strength when the resistance in the other branch is increased, and it will decrease when the resistance in this branch is decreased.

The resistance of a wire being proportionate to its length, it is only necessary to arrange, as the conductor

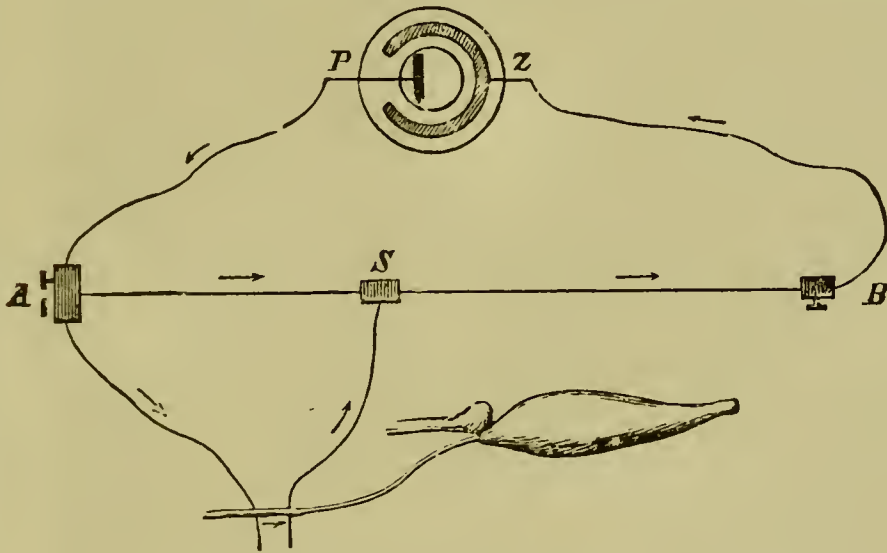

FIG. 32. RHEOCHORD.

A S, a wire the length of which can be in some way altered. The simplest way of doing this is by extending the wire in a straight line and moving a sliding-piece along it, so that any required length of the wire may be brought into the conductor. Such an apparatus is called a *rheochord*, from  $\rho\acute{\epsilon}\omicron\varsigma$ , a current, and  $\chi\acute{o}\rho\delta\eta$ , a chord—because the current is conducted along a wire extended like a chord. A rheochord of the simplest kind is represented in fig. 32. The current of the chain P Z traverses the wire A B. From A a branch con-

ductor passes to the nerve, and returns from there to the slide *S*, which slips along the wire *A B*. The branch-current traversing the nerve is strengthened or weakened according as this slide is placed further from or nearer to *A*.

By means of a rheochord of this sort there is no difficulty in making the currents within the nerve so weak that they exercise no influence at all. If their strength is then gradually increased, a pulsation is always first seen to occur in the fresh nerve when the current is closed, whatever the direction of the current within the nerve. In order to be able to indicate the direction, it has become customary to speak of such a current, when it passes within the nerve from a central to the more peripheric parts, as *descending*, and when it passes in the opposite direction, as *ascending*.

Ascending and descending currents, therefore, when they are weak, afford pulsations only on the closing of the current. If the strength of the current is increased, pulsations gradually begin to occur also on the opening of the current, at first usually with the descending current, though, when the strength is increased yet more, they occur in connection with the ascending current also. Finally, the pulsations in all four cases are of equal strength. If, however, the strength of the current is yet further increased, two of these four pulsations again become weaker—the closing pulsation with the ascending current, and the opening pulsation with the descending current. A strength of current is at last reached at which these two pulsations entirely cease, so that pulsations occur only on the closing of the descending, and on the opening of the ascending currents. These phenomena,

which represent the dependence of the excitement of the nerve on the strength and direction of the current, are spoken of as the law of pulsations. This law is represented in the following table, in which S signifies closing, O opening, Z pulsation, and R rest—i.e. no pulsation—the duration of the currents being indicated by the arrows.

LAW OF PULSATIONS IN THE CASE OF FRESH NERVE.

	Current Weak		Current of Medium Strength		Current Strong	
↓	S, Z	O, R	S, Z	O, Z	S, Z	O, R
↑	S, Z	O, R	S, Z	O, Z	S, R	O, Z

As soon as the nerve dies, the phenomena under the law of pulsations change. If weak currents are applied to a fresh nerve, which in either direction produce pulsations only on the closing of the current, and if then, the currents remaining entirely unaltered, their influence on the nerve is tested from time to time, it will be found that pulsations gradually begin to occur on the opening of the current; these are at first weak, but they continually become stronger till they are fully equal in strength to the pulsations resulting on the closing of the current. This condition is retained for some time, after which the closing pulsations of the ascending current and the opening pulsations of the descending current become weaker, and finally entirely disappear, so that the descending current produces only closing pulsations, and the ascending current only opening pulsations; and this condition endures until the excitability at the points examined is entirely expended, the pulsations be-



coming gradually weaker, and finally disappearing entirely. The law of pulsations in the case of dying nerve may also be represented in tabular form, three stages of excitability being distinguished; the signs remain the same as in the former table.

LAW OF PULSATIONS IN THE CASE OF DYING NERVE.  
(Under the Application of Weak Currents.)

	First Stage		Second Stage		Third Stage	
↓	S, Z	O, R	S, Z	O, Z	S, Z	O, R
↑	S, Z	O, R	S, Z	O, Z	S, R	O, Z

It is at once apparent that these two cases of the law of pulsation, occurring in different circumstances, entirely agree. The sequence of the phenomena which occur at the death of the nerve on the application of currents of little power is exactly the same as that which may be elicited from a fresh nerve by gradually increasing the strength of the current. In other words, if the nerve is irritated with weak, unvaried currents, these act on a fresh nerve, after a time, in exactly the same way as currents of medium strength, and, after a somewhat longer time, as powerful currents would have acted. In order to understand this, it is necessary to recall our previous experiences of the changes in the excitability at the death of the nerve. We found that in that case the excitability at first rises and attains a maximum before it again falls. Supposing, therefore, a fresh nerve is irritated by means of currents of definite but weak strength, and supposing that this nerve is examined after the lapse of a short time, during which its excitability has risen, it is evident that these weak cur-

rents must already act as would stronger, and that, when the excitability has risen yet further, that they will act as very strong currents. The expressions weak, strong, and medium currents bear no absolute meaning, the same in the case of all nerves, but must always be understood relatively to the excitability of the nerve. That which in the case of one nerve is a weak current may evidently act as much stronger in the case of another nerve the excitability of which is much greater; and, moreover, one single nerve, at different times, may be conditioned in this respect as though it were two different nerves, if its excitability has in the interval undergone considerable changes. There can, therefore, be no difficulty in understanding how, as the excitability gradually rises, the action of weak currents gradually becomes equal to that of medium and strong currents. One striking fact must, however, be observed. As the excitability after it has reached its highest point begins to fall again before it entirely disappears, it might be supposed that the same currents which at the extreme height of the excitability acted as strong currents, would now act again as currents of medium strength, and then as weak currents, before they entirely lose their power. According to this, the third stage of excitability, in which a closing pulsation is observable in the case of the descending current, an opening pulsation in the case of the ascending current, should be succeeded by a fourth and a fifth stage, of which the fourth should resemble the second, and the fifth the first. This has indeed been said to occur by some observers, but it does not appear as a rule. In explanation of this, it has been assumed that no real, but only an apparent decrease of the excitability takes place after

it has reached its highest point. It must, moreover, be remembered that it is never merely a single cross-section of a nerve which is irritated, but always a portion of greater extent, and that the excitability measured by us is in reality only the average excitability of the various points within the irritated portion. It may further be assumed that the excitability at each point, when it has reached its height, is very rapidly, if not instantaneously, destroyed. As this, however, occurs sooner at the higher than at the lower points, it follows also that the excited portion, beginning from the top, gradually becomes a powerless thread, which is, however, still capable of transmitting electricity. The excitement occurs in reality only in the lower division of the portion irritated, and this, as long as it retains any power of action, must remain at the highest point of excitability.<sup>1</sup>

4. In studying the law of pulsations we attended only to the closing and opening of the current, entirely disregarding the period during which the continuous current flowed through the nerve. In reality, the nerve, as a rule, remains unexcited during this period. Sometimes, however, especially on the application of but moderately powerful currents, an enduring excitement expressing itself as a tetanus in the muscle is observable while the current lasts. Ascending and descending currents do not behave quite alike in this matter. The latter are followed by tetanus, even in the case of currents of somewhat high power, while the ascending currents are only followed by tetanus when they are weak. In all cases this tetanus is, however, but slight, and cannot be compared with that which

<sup>1</sup> See Notes and Additions, No. 5.



may be induced by repeated separate irritations, for instance, by inductive shocks, or by frequently and repeatedly closing and opening a current. It thus appears that variable currents are better adapted for effecting the excitement of a nerve than are constant currents. Inductive currents, though their duration is extremely short, may be regarded as similar to constant currents which are re-opened immediately after being closed. True pulsations may indeed be unfailingly elicited, even with constant currents, if, by using suitable apparatus, they are but momentarily closed, and are then again reopened. But experience of the law of pulsations shows that either the closing or the opening are under certain circumstances alone sufficient to elicit pulsations. As we know that the altered condition called electrotonus is produced in the nerve by closing the current, and that on the opening of the current this condition gives place, if not immediately, yet after a short time, to the natural condition, we may, therefore, assume that the excitement of the nerve is actually due to the fact that the nerve passes from a natural into an electrotonic condition, or back again from this into its natural state. We may suppose that the smallest particles of the nerve are transferred, on the intervention of electrotonus, from their normal into changed positions, and that this motion of the particles is under certain circumstances connected with excitement. We have, however, found that a nerve, when electrotonus intervenes, is distinguishable into two parts, the conditions of which evidently differ; for in the one, that of katelectrotonus, the excitement is increased, while in the other, that of anelectrotonus, it is decreased. It might, therefore,

be possible that these two conditions differ in the relation which they bear to the excitement. Indeed, Pflüger supposed that excitement occurs only at the commencement of katelectrotonus and at the cessation of anelectrotonus. On the basis of this hypothesis the phenomena of the law of pulsations may be explained; and it becomes intelligible why on the closing and opening of the current pulsations sometimes occur and are sometimes absent. In order, however, fully to

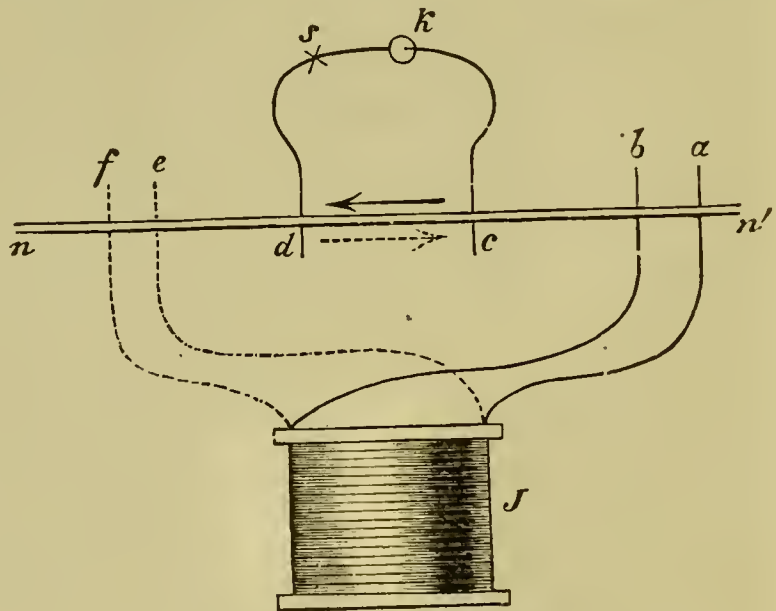

FIG. 33. ELECTROTONUS.

understand this hypothesis and the law of pulsations based upon it, we must study the phenomena of electrotonus more closely than we have yet done.

5. We have already seen that the excitability is increased on the side of the kathode during the closing of the current, and is decreased on the side of the anode. Easy as it is to prove this law under the application of weak, or medium currents, it is sometimes very hard to do so when the current causing the electrotonus is strong. Let us again imagine that the

nerve,  $nn'$  (fig. 33) is traversed between  $c$  and  $d$  by an ascending current, and that it is irritated between the points  $e$  and  $f$ , above the portion traversed by the current. The muscle is accordingly at  $n'$ , as in our previous observations. Irritation takes place on the side of the kathode. An increase in the excitability should therefore occur. This may easily be shown when the currents used for effecting electrotonus are weak. If, however, the current used for this purpose is somewhat strengthened, no increase in the excitability is observable; and, indeed, if the currents are sufficiently strong, it becomes quite impossible to effect contraction in the muscle by irritation at  $ef$ . This may seem to afford an exception to the law of the electrotonic changes in the excitability. But from the previous experiments it is evident that this must not be inferred. Possibly the excitability is in reality increased at  $ef$  in entire accordance with the law; but in order that the action of the excitement at this point should become visible, the excitement must pass through the portion under the influence of electrotonus, as well as through the anelectrotonic portion lying below the latter, and it may be supposed that this propagation of the excitement meets with an insuperable obstacle in the condition of strong anelectrotonus which prevails there. It can indeed be shown that this is the case. If the current is reversed, so that it flows in a descending direction through the nerve, then irritation at the portion  $ab$  will invariably show the existence of heightened excitement, however strong the current may be. But the portion  $ab$  is now under exactly the same conditions as was the portion  $ef$  previously. It is in itself very improbable that the nerve acts differently



in two such entirely similar cases. The difference between the two cases consists solely in the fact that in the latter the katelectrotonic point examined is situated immediately next to the muscle, so that its condition of excitability can be indicated directly by the muscle; while in the case first observed, the condition of excitability at the point *e f*, before it can find expression in the muscle, must find means of passing through the otherwise altered portions *cd* and *ab*. Now it may, on the other hand, be shown that transmission in a nerve under the influence of electrotonus really takes place at an altered speed. In the katelectrotonic portion the rate of propagation is but little altered—is, perhaps, slightly increased; but in the anelectrotonic portion it is markedly decreased. From this it may be inferred that anelectrotonus not only decreases the excitability, but also hinders the propagation of the excitement; and that where the anelectrotonus is strong, propagation is even entirely prevented.

6. This not only explains the apparent exception to the laws of electrotonus, but also affords explanation of the fact that strong ascending currents, when closed, are followed by no pulsations. We know that a strong electric current induces katelectrotonus in the upper half, anelectrotonus in the lower. According to Pflüger's hypothesis, excitement occurs in the nerve only at the point at which katelectrotonus intervenes; that is, on the closing of the ascending current, in the upper portion of the nerve. In order to reach the muscle, this excitement must pass through the lower portion of the nerve, and as this is strongly anelectrotonic, it presents an obstacle to the further passage of the excitement. The excitement which occurs in the upper half is, there-

fore, unable to reach the muscle, so that pulsation is necessarily absent on the closing of the current.

In order to apply the corresponding case to the opening of a descending current, the help of another hypothesis is required, according to which the great modification which follows the disappearance of katelectrotonus, and which so greatly decreases the excitability, also involves a hindrance to transmission. This assumption has not yet been experimentally proved; proof is indeed difficult, on account of the ephemeral character of the modifications. The similarity of negative modification to anelectrotonus, both decreasing the excitability, favours the hypothesis that in negative modification also an obstacle is afforded to transmission. According to this view, the case is the same on the opening of a descending current as on the closing of an ascending current. According to Pflüger's hypothesis excitement occurs on the opening of a current only in that portion of the nerve at which anelectrotonus disappears. This, in the case of a descending current, is the upper portion of the nerve. In order to reach the muscle thence, the excitement would have to traverse the lower portion, which is at the same time taken possession of by a strong negative modification, and this prevents propagation of the excitement; no opening pulsations, therefore, occur in the case of the descending current.

Pflüger supported his hypothesis by the following experiment. Mention has already been made of the so-called Ritter's tetanus, which intervenes when a current which has traversed a nerve for some time is interrupted. According to Pflüger's hypothesis, this excitement should also be located on the side of the

anode. If an ascending current is passed through a nerve, the anode side is situated in its lower portion; but if the current is descending, then it is situated in the upper portion. If Ritter's tetanus is induced by means of a descending current, and if the nerve is bisected between the electrodes immediately after the opening of the current, the tetanus at once ceases. If the same experiment is tried with an ascending current, then the cutting of the nerve in no way influences the tetanus.

Yet another proof of the truth of this hypothesis is afforded by Pflüger's study of the excitement of the sensory nerves by an electric current. As the terminal apparatus of sensory nerves, by the action of which the irritation is recognised, is situated at the opposite end of the nerve, it seems that the law of pulsations should prevail in an opposite way to that in which it prevails in the case of the motor nerves. Pflüger ascertained that in reality strong ascending currents induce sensation only when closed, strong descending currents only when opened. The explanation is the same in this case as in that of the motor nerves. On the closing of the descending current, excitement occurs in the lower portion of the nerve. In order to effect sensation the excitement must pass to the spinal marrow and the brain; it would have, therefore, to pass through the upper parts of the nerve, where it would be checked by the strong anelectrotonus which prevails there. The opening of the ascending current has a similar irritating effect on the lower parts of the nerve. In order to reach the spinal marrow and brain, this excitement would have to pass through the upper parts, where, in this case, it would be checked by the strong negative modification.



The only explanation of the fact that weak currents, whatever their direction, act only on being closed, is that the changes in the nerve probably begin more quickly than they disappear on the closing of the current. The differences are, however, very slight; and a very slight strengthening of the current suffices to elicit opening pulsations of the nerve also. This is especially true of the descending current; if the nerve is not quite fresh, opening pulsations may occasionally be observed even in the case of very weak currents which do not as yet afford any closing pulsations. This is connected with the circumstance that the excitability is somewhat greater in the upper than in the lower portions of the nerve. The natural superiority of the closing pulsation is thus cancelled in the case of the descending current, and opening pulsation is consequently rendered more easy.

7. From what has been said it seems very probable that every excitement in the nerve is due to a change in its condition, which might be directly shown in the case of the electric current by the electrotonic change in the excitability. The more quickly these changes occur, the more easily are they able to excite the nerve. This law is exhibited even in the case of non-electric excitement. It is, for instance, possible by gradually increasing pressure on the nerve entirely to crush the latter without producing any excitement, though every sudden pressure is, as we have seen, inseparable from excitement. A similar fact may be observed in the case of thermic and chemical irritation. From this it may be inferred that the excitement in the nerve is due to a certain form of motion of its smallest particles, and that a sudden blow is better

adapted for exciting this motion than is slow action. That even slight mechanical disturbances are capable of producing excitement, although the nerve is not crushed, has been proved by Heidenhain. He attached a small ivory hammer to the instrument which we have already described under the name of Wagner's hammer, and, having laid the nerve on a small ivory anvil, placed the latter under the hammer in such a way that the latter tapped gently on the nerve. The result of this was strong tetanus lasting for several seconds. To obtain a more accurate conception of the mechanism of nervous excitement, it would be necessary first to learn accurately the arrangement of the smallest particles in the quiescent nerve. Now we shall later on examine certain behaviour of the quiescent nerve from which conclusions may be drawn as to the regular arrangement of the smallest particles. While postponing the closer examination of these details, we may at present try to explain the facts of excitement as clearly as circumstances permit. For this end we will assume that the particles of the nerve are retained in an entirely definite relative position by molecular forces. Excitement can, accordingly, only intervene when the particles are displaced from this position and are set in motion. The more powerful are the forces which retain the particles in their balanced position, the greater must be the forces which move them, and, therefore, the smaller is the excitability. It must also be explained that the separate particles of the nerve mutually influence each other, each particle influencing the other and helping to retain it in its relative position. A comparison drawn by du Bois-Reymond may be used to make this somewhat involved explanation more

intelligible. It is a well-known fact that a magnetic needle suspended by a thread assumes such a position, in consequence of the magnetic attraction of the earth, that one of its ends points to the north, the other to the south. Now, supposing a series of many magnetic needles, all suspended one behind the other in the same meridian line, as in fig. 34, then each of these needles

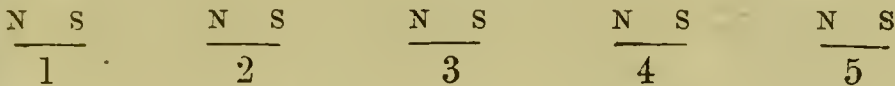

FIG. 34. A SERIES OF MAGNETIC NEEDLES ARRANGED AS A DIAGRAM OF THE PARTICLES OF A NERVE.

will be yet more firmly retained in its position by its neighbours, for the adjacent north and south poles of the needles mutually attract each other. If, for example, we wish to move the middle needle, No. 3, more force must be used to do this than would be necessary if the needle were alone. But when the centre needle is turned, the immediately adjacent needles cannot remain at rest, but are similarly deflected; these exercise a similar deviating influence on their neighbours; and so on. So that the disturbance created at one point in this series of magnetic needles passes like a wave through the whole series.

This evidently bears much resemblance to that which takes place in nerves. It explains not only how a disturbance commencing at any point in the nerve propagates itself, but also how each separate part of the nerve is able to influence the other parts. We have already found that the excitability of any point of the nerve increases if the immediately superior portion of the nerve is cut away. The magnetic needles show that just in the same way each is more readily move-



able when some of its neighbours have been removed. Without, therefore, assuming other resemblances between the forces which act on the magnetic needles and those present in the nerve, we may accept the comparison so far that we may imagine the nerve to consist of separate minute particles, arranged one behind the other in the longitudinal direction of the nerve, and mutually retaining each other in their position. Now, if there are forces which retain the particles in this relative position yet more firmly, it is evident that they must lessen the excitability; while, on the other hand, such forces as tend to move the nerve-particles from their relative positions must at the same time decrease the strength of their connection, and must therefore render the nerve more excitable. As regards the electric current, we have seen that the two poles act on the nerve in opposite ways. We may, therefore, assume that by one pole, the positive, the nerve particles are retained in their quiescent position, while by the negative pole, on the other hand, they are disturbed from this position. If this is the case, it explains the fact that excitement occurs only at the negative pole when the current is closed. The excitability is increased at the positive pole on the opening of the current; here, therefore, there occurs a movement of the particles such as follows the closing in the negative pole, so that in this case the excitement can occur on the opening of the current.

The fact that the nerve remains unexcited by changes in its condition, although these same changes if they occur suddenly do induce excitements, bears so significantly on the explanation of the nervous processes, that we must study it in yet greater detail. The fact

may be most easily and surely shown in the case of electric excitement, as there is no difficulty in allowing the strength of the currents to increase or decrease more or less gradually. Let the apparatus be arranged as in fig. 35 in which the nerve is traversed by a

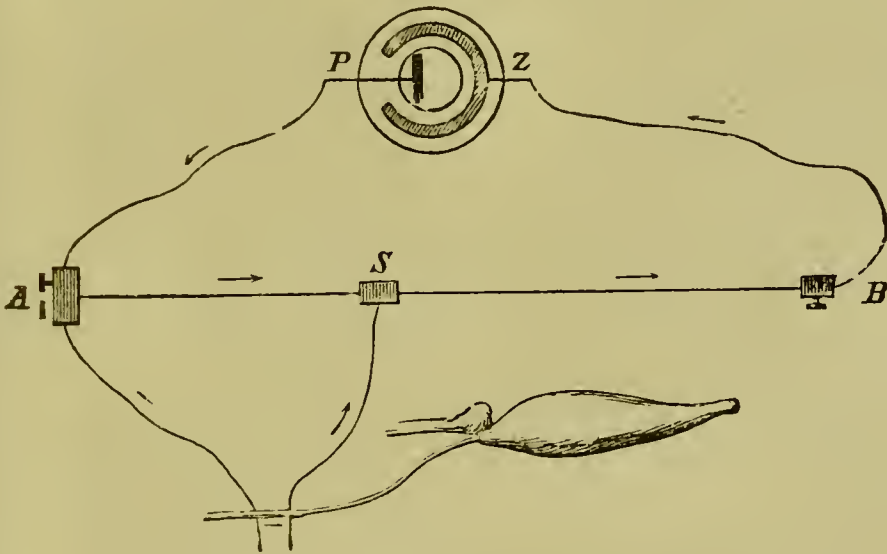

FIG. 35. RHEOCHORD.

current, the strength of which may be altered by moving the slide *S*. Let a key be inserted in the circle, and let the slide be so placed that pulsations occur on the closing and the opening of the current. On placing the slide *S* close to *A* (in which position the resistance in the branch *A S* is nil, so that no current passes through the nerve), and pushing it slowly forward to its former position at *S*, the current within the nerve slowly increases from zero to its former strength: on again pushing the slide slowly back till it touches *A*, the strength of the current again slowly decreases to 0. In neither of these cases is the nerve excited. As soon, however, as the movement of the slide is in any way effected

<sup>1</sup> E. du Bois-Reymond has described apparatus of this sort under the name of *Schwankungsrheochord*.

with great speed,<sup>1</sup> the nerve is excited and the muscle pulsates. When, therefore, the current being closed or opened by means of the key, the nerve is excited, this is due to the fact that the strength of the current increases with great rapidity from zero to its full strength, or sinks from the latter to zero.

The facts thus observed explain why inductive shocks, which are of but very short duration, and in which closing and opening follow each other in such rapid succession, are so especially capable of exciting the nerve. All inductive shocks are not, however, equally adapted for this purpose. When, making use of the inductive apparatus already described, the current in the primary coil is closed and then interrupted, the result is the creation of two currents differing in their direction in the secondary coil, these being the closing inductive current and the opening inductive current. If these are made to pass through a nerve, the exciting influence of the latter is always much greater than that of the former. This can be very plainly shown by placing the secondary coil at a distance from the primary. By this means, a distance may always be found at which the opening inductive current is active, while the closing inductive current as yet exercises no influence; if the coils are then brought nearer to each other, the latter also becomes active. If, however, when the coils of the inductive apparatus are in any position, the secondary coil is connected with a multiplier, then the deflections of the magnetic needle are always of equal strength in the case of both inductive currents. The nerve, therefore, exhibits a difference which the multiplier is incapable of indicating. It has, however, been shown that the two inductive currents



differ entirely in duration. The closing inductive current increases slowly, and decreases just as slowly, while, on the other hand, the opening inductive current very rapidly attains its full strength and ends just as quickly. It is to this difference that the latter evidently owes its greater physiological effect.<sup>1</sup>

Let us return to the experiment as first arranged with the rheochord. Instead of pushing along the slide between *A* and *S*, it may be moved backward or forward between any two points. The current in the nerve, in this case, never ceases, but is either strengthened or weakened according to the direction in which the slide is moved. If the latter is moved suddenly and with great speed, it may produce excitement; but the nerve always remains unexcited when the movement is gradual. It therefore appears that it is not the actual closing and opening of a current which is required to excite the nerve, but that any change, whether it strengthens or weakens the current, is sufficient to effect this, provided that the alteration is sufficiently great and sufficiently rapid. Closing and opening are but special cases of alteration of the current in which one of the limits to the strength of the current = 0. The following law regarding the electric excitement of nerve may therefore be stated: *any change in a current traversing a nerve may excite the latter if it is sufficiently strong, and if it occurs with sufficient speed.* We have however seen that this law has very many exceptions. For under certain circumstances a greater alteration (the closing of a strong ascending current) may appear to be without effect, although one less strong takes effect. If, however, it is

<sup>1</sup> See Notes and Additions, No 6.

admitted that in such cases excitement does in reality take place, but that it is not observable on account of external circumstances (hindrance to the propagation to the muscle), then these exceptions may be said to be merely apparent. Moreover, assuming that the changes in the strength of the currents within the nerve only excite in consequence of the fact that they bring about changes in the molecular condition of the nerve, and combining with this all that we know of the effect of other forms of nerve irritation, the following law regarding nervous excitement may be regarded as the final result:—

*Excitement of the nerve depends on a change in its molecular condition. It occurs as soon as such a change is effected with sufficient speed.*

It may be added that this law is in all essential points true also of muscle. But it appears that the molecules of muscle are more sluggish than are those of nerve, so that in the former very transient influences may more easily be without effect.<sup>1</sup>

<sup>1</sup> See Notes and Additions, Nos. 7 and 8.

## CHAPTER IX.

1. Electric phenomena; 2. Electric fishes; 3. Electric organs; 4. Multiplier and tangent galvanometer; 5. Difficulty of the study; 6. Homogeneous diverting vessels; 7. Electromotive force; 8. Electric fall; 9. Tension in the closing arch.

1. As yet in examining the essential qualities of muscles and nerves we have disregarded a series of important phenomena common to both, in order that we may now treat them as a whole. We refer to the electric actions which proceed from these tissues. Muscles and nerves are especially distinguished among all other tissues of the animal body by the fact that they exercise very regular and comparatively powerful electric action; and from the relation existing between electric currents and the excitability of muscles and nerves it may be inferred that these independent electric actions bear some relation to the essential qualities of muscles and nerves.

It is true that electric action is exhibited in other animal, as well as vegetable tissues; but these are very slight, and are apparently insignificant.<sup>1</sup> Electric currents are so easily generated under all circumstances that it is not very surprising that traces of them are

<sup>1</sup> An exception is perhaps afforded by the electric phenomena of the leaves of *Dionæa muscipula* which will presently be mentioned.



everywhere to be found. In the researches in which we are about to engage, we must always endeavour as far as possible to exclude these accidental currents, or at least to distinguish them from those currents which it is our task to examine, and the causes of which lie in the animal tissues themselves. Apart from muscles and nerves, but one tissue seems endowed with somewhat strong electric action; this is that of the glands. This has, indeed, not as yet been fully proved, but it has been shown to be in a very high degree probable. In connection with this it is a very interesting fact that the glands are in some physiological respects very similar to the muscles, and that they bear the same relations to nerves as do muscles.

2. There is, on the other hand, a tissue in which electric action is exhibited in far greater strength, so that its nature was known long before it was recognised that muscles and nerves possess the same capacity. This tissue does not, however, occur in all animals, but only in a few fishes, which on this account are called electric fishes. In these animals special organs of peculiar structure occur, in which, as in an electric battery, currents of very considerable strength arise, the discharge of which is caused by the influence of the will, the animal using this power to frighten its enemies, or to benumb and kill its prey. Long before the world knew anything accurately as to the physical nature of electric phenomena, such powerful influences as are exhibited in electric fishes did not fail to attract the attention of chance observers. Notices of these remarkable phenomena are actually found in ancient writers; and the Roman poet Claudius Claudianus<sup>1</sup>

<sup>1</sup> He lived in Alexandria toward the end of the fourth century.

has given a very vivid description of these actions in the following lines:—

‘Who has not heard of the power of the dreadful ray, of the benumbing force to which it owes its name.<sup>1</sup> Formed only of gristle, it swims slowly against the waves or creeps sluggishly on the waterwashed sand. Nature has armed it with an icy poison, has poured into its marrow coldness to freeze and stiffen all living things, and has filled it with everlasting winter. To these gifts of nature it adds craft, and, conscious of power, it remains quietly stretched among the sea-grasses; yet when some animal, swimming upward to the sea-top, passes near, unpunished it fearlessly feeds on the living limbs. Nor when, having carelessly bitten at some bait, it feels the line, the bent hook in its mouth, does it attempt flight, biting itself free, but craftily creeping yet nearer to the dark hair-line, conscious of its power, it pours the electric breath from its poisonous veins far and wide over the water. The electric fluid flashes along hook and line, harming even the fisherman where he stands above the water; from the lowest depth the dreadful lightning flashes, and passing along the hanging line, by the magic of its power carries cold as of ice through the rod, wounding the strong arm and curdling the blood of the fisherman, who, terror-struck, throws away the baneful prey, and, careless of his line, hurries homeward with dismay.’

After the theory of electricity had received a new development in consequence of the discoveries of Galvani and Volta, these fishes were frequently studied

Older notices of the *Torpedo* occur in Pliny, Ælian, Oppian (whose poem on fishing Claudianus appears to have known), and in Aristotle.

<sup>1</sup> *Torpedo*, from *torpor* = numbness.

by various observers, and the electric character of their innate force was incontrovertibly shown. Faraday's study of the electric eel, and du Bois-Reymond's of another electric fish, are especially important.

There are three fishes, especially, which have been proved to possess this capacity for giving electric shocks. These are, the electric ray of the Adriatic and Mediterranean (*Torpedo electrica* and *T. marmorata*); the electric eel (*Gymnotus electricus*), which occurs in the fresh waters of South America; and lastly, another electric fish (*Malapterurus electricus* or *M. beninensis*), which has but recently been carefully studied, and which occurs in the rivers of the Bay of Benin on the east coast of Africa. We cannot omit this opportunity of inserting Alexander von Humboldt's description of the electric eel and its action<sup>1</sup>:—

‘The crocodile and the jaguar are not, however, the only enemies that threaten the South American horse; for even among the fishes it has a dangerous foe. The marshy waters of Bera and Rastro are filled with innumerable electric eels, which at pleasure are able to discharge a deadening shock from every part of their slimy, yellow-speckled bodies. This species of gymnotus is about five or six feet in length. It is powerful enough to kill the largest animals when it discharges its nervous organs at one shock in a favourable direction. It was once found necessary to change the line of road from Uritucu across the savannah owing to the number of horses which, in fording a certain rivulet, annually fell a sacrifice to these electric eels, which had accumulated there in great numbers. All other species of fish shun the vicinity of these formidable creatures.

<sup>1</sup> *Views of Nature.*



Even the angler, when fishing from the high bank, is in dread lest an electric shock should be conveyed to him along the moistened line. Thus, in these regions, the electric fire breaks forth from the lowest depths of the waters.

‘The mode of capturing the *gymnotus* affords a picturesque spectacle. A number of mules and horses are driven into a swamp, which is closely surrounded by Indians, until the unusual noise excites the daring fish to venture on an attack. Serpent-like, they are seen swimming along the surface of the water, striving cunningly to glide under the bellies of the horses. By the force of their invisible blows numbers of the poor animals are suddenly prostrated; others, snorting and panting, their manes erect, their eyes wildly flashing with terror, rush madly from the raging storm; but the Indians, armed with long bamboo poles, drive them back into the midst of the pool.

‘By degrees the fury of this unequal contest begins to slacken. Like clouds that have discharged their electricity, the wearied eels disperse. They require long rest and nourishing food to recover the galvanic force which they have so freely expended. Their shocks become weaker and weaker. Terrified by the noise of the trampling horses, they timidly approach the brink of the swamp, where they are wounded by harpoons, and drawn on shore by non-conducting poles of dry wood.

‘Such is the remarkable contest between horses and fish. That which constitutes the invisible but living weapon of these inhabitants of the water—that which, awakened by the contact of moist and dissimilar particles, circulates through all the organs of animals and

plants—that which, flashing amid the roar of thunder, illuminates the wide canopy of heaven—which binds iron to iron, and directs the silent recurring course of the magnetic needle—all, like the varied hues of the refracted ray of light, flow from one common source, and all blend together into one eternal all-pervading power.’

3. All electric fishes are distinguished by the possession of peculiar organs in which the electric discharge originates. These resemble powerful batteries, which can be put in action by the will of the animal, and which then generate currents which, passing through the water, meet and act upon other animals which happen to be near, so that the latter may even be thus killed. These *electric organs*, as they are called, are formed on the same plan in all the three above-mentioned genera of fishes. They consist of a large number of minute and delicate plates which, arranged side by side and enclosed in coverings of connective tissue, form the whole organ. In the *Torpedo* these organs lie flat on either side of the vertebral column. In the *Gymnotus* and the *Malapterurus* they are arranged longitudinally; and in the latter they form a closed tube, in which the animal is concealed, its head and tail, as it were, alone projecting. The separate plates of which the organ consists are arranged, therefore, horizontally in the *Torpedo*, vertically in the *Gymnotus* and *Malapterurus*. Each of these plates consists of an extremely delicate membrane which, when the organ is in a state of activity, exhibits positive electricity on the one side, negative on the other. The currents of the numerous plates combine as in a battery, and thus all together afford a very powerful current. With each

plate is connected a nerve-fibre, by means of which the animal is capable of voluntarily effecting the electric discharge, just as voluntary muscular contractions can be effected by means of the nerve. These nerves may also be artificially irritated, with the result of producing one or more electric shocks, just as irritation of a motor nerve elicits one or more muscular contraction. The analogy of electric organs and of muscle is, in fact, from a physiological point of view, complete.

Mention must yet be made of the fact that forms nearly allied to these fishes—for instance, the various forms of *Mormyrus*, which in structure resemble rays—possess similar organs, though these have not as yet been shown with any certainty to be capable of any electric action. It has, moreover, been assumed that the luminous organs of certain insects are to be referred to electric forces; but this has not been in any way proved.

4. Before entering further into the statement of the electric phenomena in animal structures it will be necessary to say something of electric phenomena in general, and of the means of exhibiting them.

It is well known that an electric current results when two different metals are in contact with each other, or with a fluid. Electricity occurs in this case as a current, that is, in a state of motion; while in other cases it exists in a quiescent condition. On immersing a piece of copper and a piece of zinc, as in fig. 36, in a glass containing diluted sulphuric acid, and then uniting these above the fluid by a wire, the positive electricity passes through the wire from the



FIG. 36.  
AN ELECTRIC  
CURRENT.



copper to the zinc, and through the liquid from the zinc to the copper. A magnetic needle is used to indicate the presence of such a current. An electric current, if made to pass parallel to a magnetic needle, deflects the latter from its normal position, and tends to place it at right angles to its original position. According to the direction in which the positive electricity flows, and according to the position of the conducting wire relatively to the magnetic needle, the north pole of the needle is deflected either to the east or to the west; so that not only the actual presence of an electric current may be shown by means of a magnetic needle, but its direction in the wire may also be determined. This simple means, however, only serves the purpose when the current is comparatively strong, for the magnetic needle is retained in its position by the attraction of the earth, and the magnetic current must overcome this before it can deflect the needle. In order to detect weak currents, the wire through which the current flows is wound in several coils round the needle. As each coil exercises a force tending to cause the deflection of the needle, the deflecting force is increased; and an instrument of this sort is, therefore, called a *multiplier*.<sup>1</sup> In order to increase the sensitiveness of this still further, the attraction of the earth must be annihilated as far as possible, so that even weak currents are able to cause deflection. This is accomplished, for instance, by arranging a fixed magnet above or below the magnetic needle, so that it acts on the latter in a direction con-

<sup>1</sup> If attention is paid to certain circumstances, which cannot be mentioned in detail here, the same instrument can also be used to measure the strength of currents; it is, therefore, also called a *galvanometer*.

trary to that of the attraction of the earth, and by carefully bringing this magnet nearer until the action of the earth is almost entirely cancelled. Or two mag-

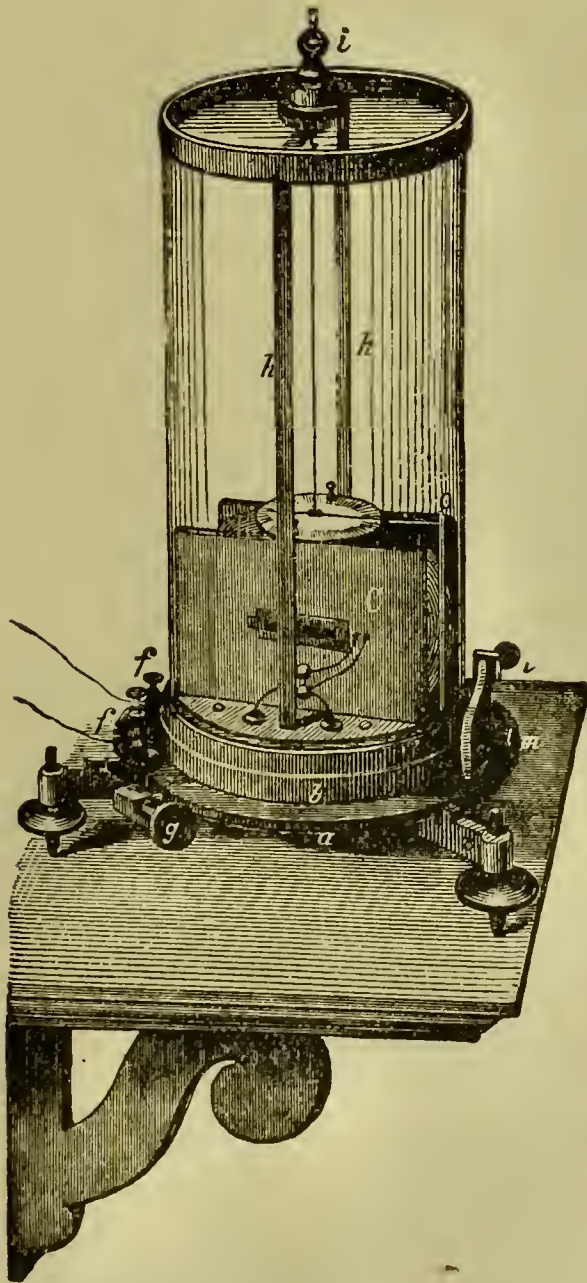

FIG. 37. A MULTIPLIER.

netic needles, as similar as possible, are connected by a fixed intermediate piece in such a way that the corresponding poles are turned in opposite directions. As the force of gravitation now tends to turn the two

needles in opposite directions, the force of attraction of the earth-magnetism is entirely, or almost entirely removed, so that even very weak electric currents, if caused to pass round the needle in a suitable way, can cause a noticeable deflection of the needle.

Fig. 37 represents a sensitive multiplier of a form well suited for physiological experiments. The two needles are connected together, and are suspended by means of a thread of silk from the frame  $h' h$ ; the screw  $i$  serves to raise the needles to a proper height, so that one of them can move freely within the coils of the wire, the other above the latter and over a graduated circle, by which the deflection effected by the current can be measured. The very thin wire, enclosed in silk, is wound on to the frame  $C$ ; the binding screws  $f' f$  serve to transmit the current.

The use of the multiplier for physiological purposes has recently considerably decreased, owing to the more perfect adaptation of another form of apparatus, called the tangent galvanometer, for such purposes. The advantage of this consists in the fact that it is not only very sensitive, but it also allows the strength of the current to be measured. If, for example, the deflections of the magnetic needle are very slight, the strength of the currents may be regarded as proportionate to the trigonometrical tangents of the angle of deflection.<sup>1</sup> In order to measure slight deflections of this sort, our former method of observation by means of the mirror and lens may be used (chap. iv., § 3, p. 57). Either the magnet is in itself reflecting, or it is connected with a mirror, and is suspended by a silk thread in a copper sheath,  $A$ , which is closed by plates of looking-

<sup>1</sup> See Notes and Additions, No. 9.



glass. The electric current can be transmitted through the coils  $B' B$ , which move on slides, in order that by their greater or lesser distance from the magnet, the

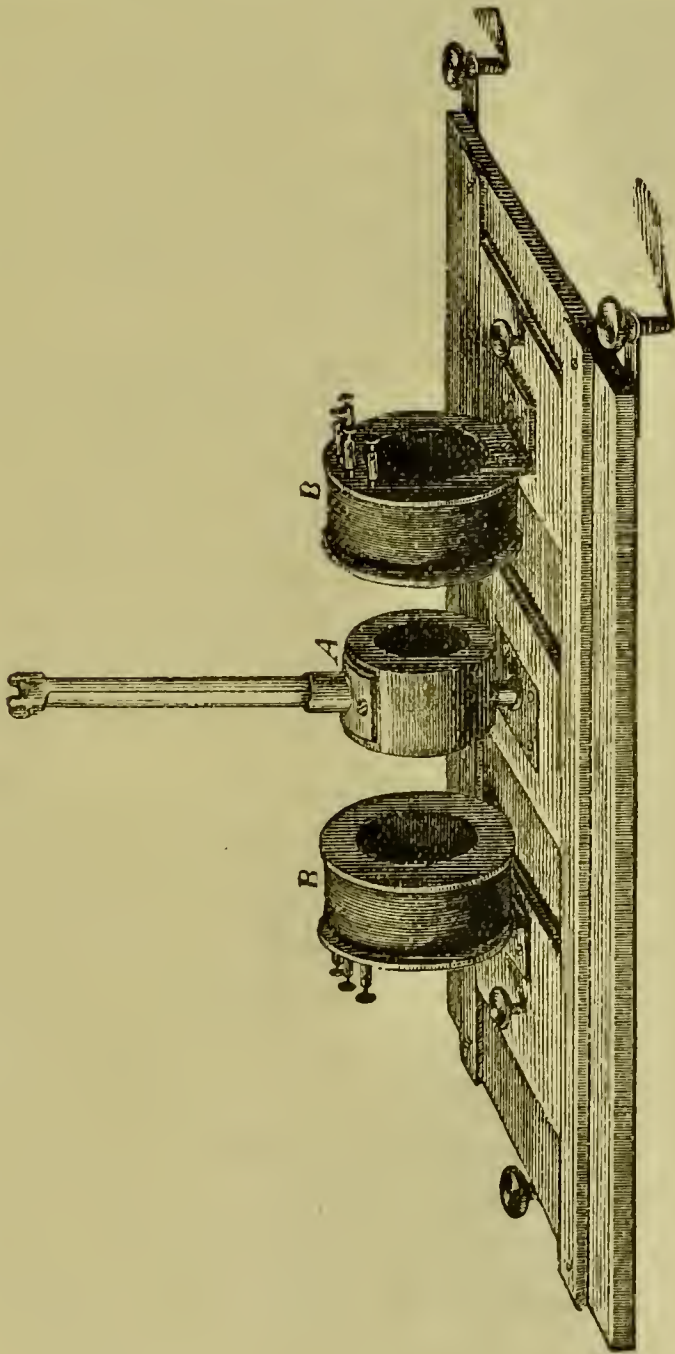

FIG. 58. REFLECTING GALVANOMETER.

sensitiveness of the instrument may be graduated at will. In order to measure the deflections, a graduated scale is placed parallel to the mirror when in its qui-

escent position, and its reflection is observed through the lens as described in Chap. IV., § 3. This may also be used to render the deflection visible to a large audience, by allowing the light of a sufficiently powerful lamp to fall on the mirror and throwing the reflection on to a screen by means of a lens. In order to increase the sensitiveness of the instrument, the influence of gravitation on the deflecting magnet is decreased, as already described, by means of a properly arranged magnet.

5. Having, in one or other of these ways, provided as sensitive a multiplier as may be, all that is necessary is to connect the animal substances which are to be examined with this, and then to observe whether deflection occurs or not; whether, that is, with the arrangement selected a current is present or not. But the more sensitive is the multiplier, the harder is it to connect any part of an animal with it in such a way that no current occurs, and it would be a mistake to suppose that all these currents are elicited by the animal substances themselves. If, for example, the ends of the wires of the multiplier are connected with two wires of the same metal—for example, copper; and if these wires are immersed in a conducting fluid—for example, diluted sulphuric acid—considerable deflection of the needle always occurs, owing to the fact that the copper wires are never so homogeneous that they do not themselves generate a slight current. If platinum wires are used instead of copper, these can, it is true, be rendered homogeneous by careful cleaning; but this homogeneity soon disappears, so that even with this metal currents result which depend solely on the dissimilar nature of the metallic surfaces. Fortunately,

there are combinations of metals with fluids which are free from these faults. Two pieces of zinc, the surfaces of which have been amalgamated by smearing with quicksilver—which have, therefore, been equally covered with a coating of zinc-amalgam, a combination of zinc and quicksilver—act as though entirely homogeneous if they are immersed in a solution of sulphate of zinc; and these metals retain their homogeneity even when electric currents traverse the metals and the fluids. The wire of the multiplier may be connected with strips of amalgamated zinc of this sort, and these may be immersed in a solution of sulphate of zinc without any deflection being indicated even by a very sensitive multiplier. While, therefore, it might lead to serious error if the wires of the multiplier were brought into immediate contact with the animal substances to be examined—as electricity would, in such case, be generated at the point of contact itself—it is possible, by using this amalgamated zinc and solution of sulphate of zinc, to exclude any foreign source of electricity, and, provided that the animal tissue is properly inserted, to be sure that the observed deflections of the magnetic needle are really due to electric forces situated in the animal substances themselves. The point to be aimed at in this experiment is, therefore, to place the animal substances in such a position that any currents generated in them can only pass to the wire of the multiplier through the zinc solution and the plates of amalgamated zinc.

6. In order to attain this object, du Bois-Reymond, to whom is chiefly due our knowledge of the electric phenomena of animal tissues, arranged the apparatus in the following way (fig. 39). The ends of the wires



of the multiplier were connected with two troughs or vessels of cast zinc, the outer surfaces of which had been lacquered, while the inner cavity had been carefully amalgamated. A solution of sulphate of zinc was poured into this cavity, and pads, formed of many folds of blotting-paper saturated with the same solution, were folded over the edge of the vessels in such a way that

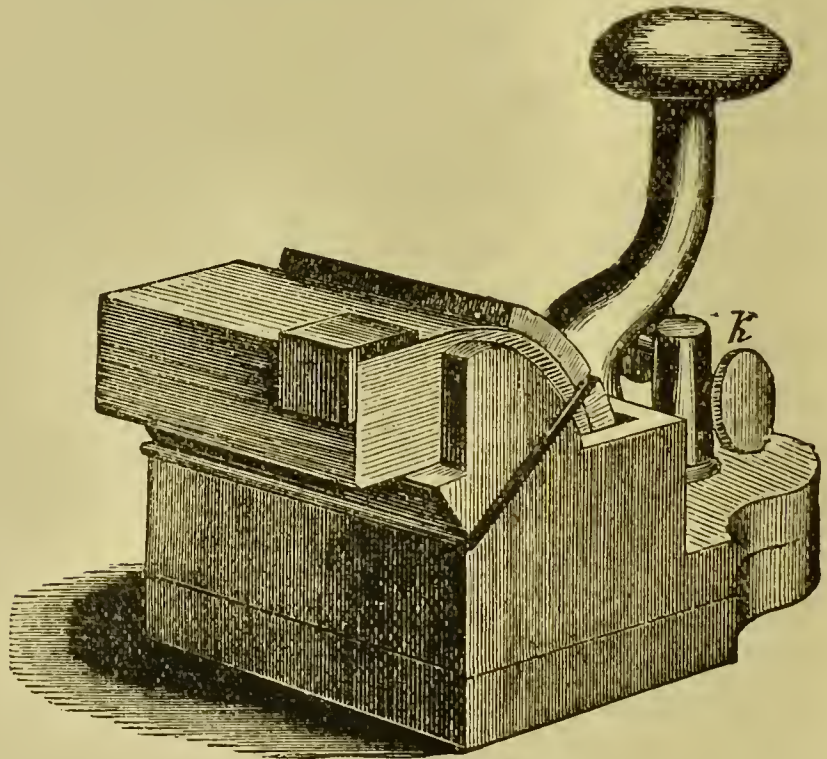

FIG. 39. HOMOGENEOUS DIVERTING VESSEL, AS USED BY E. DU BOIS-REYMOND.

part was immersed in the solution, part protruded over the edges, and these pads end in a sharply cut cross-section. Small discs of an isolating substance (vulcanised india-rubber), with the help of caoutchouc bands, retained the pads in their places. The vessels being pushed toward each other till the pads touched, or the intermediate space between the pads being bridged by a third pad, also saturated with a solution of sulphate of zinc, the needle of the multiplier continued unmoved.

thus affording proof that no cause of the generation of currents is present in any part of the apparatus. If the body to be examined is then substituted for the third pad, with the result of deflecting the needle, proof is afforded that some cause effecting the generation of a current exists in the body. The only disadvantage of the arrangement is that the animal substances thus examined, being in contact with the concentrated solution of sulphate of zinc, are corroded, and their vital qualities are injured. To avoid this, so-called protective shields, i.e. thin plates of plastic clay (porcelain) which has been mixed with a diluted solution of common salt ( $\frac{1}{2}$  to 1 per cent.), are used. These are placed on the pads of blotting-paper, where the tissue to be examined touches the latter. The clay protects the tissue from direct contact with the solution of sulphate of zinc, though, clay being a conductor, the electric action present in the tissues can reach the zinc and the wires of the multiplier.

7. In examining muscles or nerves by this method, according to the way in which the animal substance is applied, sometimes no deflection of the magnetic needle is observable, sometimes slight, and sometimes stronger deflections appear. The same body, for example a piece of muscle, may in one position afford a very strong current, while in another position it affords none at all. In order to understand this, we must examine the way in which the electric currents present within the tissue examined are able to impart themselves to the wire of the multiplier, in the case of the method of experiment selected.

Let us revert to the simple apparatus (fig. 36, p. 159), in which we first studied the action of electric currents

on a magnetic needle. A piece of zinc and a piece of copper are immersed in diluted sulphuric acid, their projecting edges being connected by a piece of wire. When in this condition the apparatus is said to be closed. Within it circulates a current which passes within the wire from the copper to the zinc, and within the fluid from the zinc to the copper. If the closing wire is observed by itself, no current arises in it until it is joined to the apparatus. And if the apparatus is observed by itself, that is, without the closing wire, there is no current present in it. It is only in a closed circle that a current can be generated. It is, however, in the apparatus that the cause which under favourable circumstances gives rise to the electric current, lies; for if the wire by itself is bent into a circle no current is generated within it. Even the cause of the generation of currents within the apparatus may be shown. If when the apparatus is open, that is, when the circuit is not completed by the addition of the connecting wire, the projecting edges of the copper and zinc are connected with an electrometer, the gold leaflets are seen to diverge, thus showing that an electric tension prevails at these metallic ends projecting from the fluid. This tension is positive at the copper end, negative at the zinc end. On connecting the two metals by a closing wire, the opposed electric currents unite, and this is the cause of the current in the wire. The force which within the wire exhibited electric tension continues to act, and causes the current to continue to traverse the wire. This is called the *electromotive force* of the apparatus. It expresses itself, when the apparatus is not closed, in the electric tension at the projecting metallic ends or poles of the apparatus; and when the



poles are connected together by a closing arch, it finds expression in the current which it generates in this arch.

Supposing that the two metals contained in the fluid did not protrude from the latter, but were in contact with each other within the fluid, then it is evident that the apparatus would be closed in this case also, but the closing arch would then lie within the fluid. Through this the current must pass from the copper to the zinc, and from the zinc to the copper through the fluid. That this is really the case can easily be shown, for on the immersed metallic surfaces globules are seen to be generated, due to the gases generated by the electric current by the separation of the water into its constituent parts, hydrogen being found at the copper, oxygen at the zinc point. In this case, therefore, the apparatus is in itself closed. No external closing-arch is present, the existence of a magnetic current at which can be indicated by means of a magnetic needle. Yet with a multiplier it is possible to show the currents circulating in the fluid, and in the immersed metals; this may be done by a principle spoken of as the distribution of electric currents.

Let us assume that an apparatus *k* is not directly closed by a closing-arch, but that from each pole passes a wire which touches the conductor, the form of which does not matter, shown in fig. 40 at two points, *A B*. It can be shown that the electric currents pass in this case through the body, but distribute themselves, not merely in straight lines connecting *A* and *B*, but throughout the body, so that they represent a number of lines of conduction, all of which meet together at the points *A* and *B*, where the electric currents enter

and leave the body. If the body which is inserted is of simple form, the separate lines of transmission may easily be calculated from the form; in bodies of irregular shape this is somewhat hard to do, but even in such cases it is possible to determine experimentally, not only that the electricity distributes itself throughout the body, but even the lines along which the separate currents pass.

Taking a simple example, for instance, a thick cylindrical rod, in which the electricity passes in at the

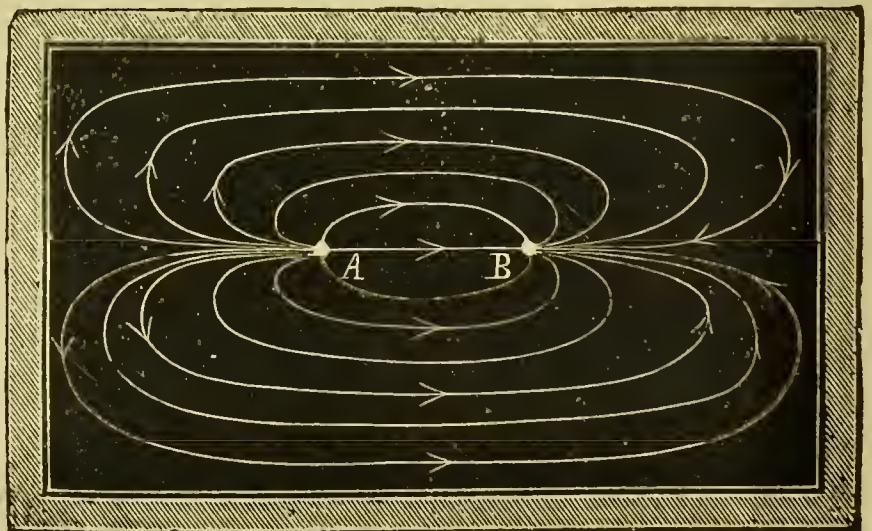

FIG. 40. DISTRIBUTION OF THE CURRENTS IN IRREGULAR CONDUCTORS.

surface of one end and out at the other, it is *prima facie* probable that the lines simply traverse the length of the rod parallel to its axis. We may in imagination replace the rod by a bundle of wires, each of which will in this case be traversed by a portion of the whole current. If one of these wires is cut, and its ends are connected with the multiplier, it is evident that that part of the current which traverses this wire must pass to the multiplier and cause a deflection of the needle. But even if the wire is not cut, but is con-

nected with the multiplier at two points in its length, in this case also a part of the current must, in accordance with the law of the distribution of currents, branch off through the multiplier.

8. This may be made intelligible in another way. We saw that a certain electric tension exists at the poles of an open apparatus, and that the opposed tensions of the two poles are the causes of the current in the closing wire. If the poles were but once charged with proper quantities of electricity, these would unite in the wire, with the result of producing an instantaneous current. But as, in consequence of the electromotive force of the apparatus, the tension at the poles is continually renewed, the current is continuous. So that at both ends of a closing wire opposed tensions prevail constantly, and these act on the natural electricity present in the wire, as in every other body, and set it in motion. Consequently, while the current flows through the wire, different tensions must prevail at the various points of the wire. At the point of contact with the positive pole there is a definite positive tension; at the point of contact with the negative pole there is a similar negative tension, and in the middle of the wire there must be a point at which the tension = 0. This may be diagrammatically shown by representing the tension which prevails at each point of the wire by a line described at right angles to the wire, the length of which represents the tension proper to the point in case. Let  $ab$  (fig. 41) be the wire; then the line  $ac$  is the expression of the tension existing at one of its ends, which is connected with the positive pole. In order to indicate that the tension at the other end,  $b$ , is negative i.e. of an opposite kind, let the line  $bd$  be



drawn downward from  $a$   $b$ . In the centre there is no tension. At any point between the middle and the end  $a$ , say at  $e$ , a positive tension must prevail which is less than that at  $a$ , but greater than 0. It is expressed by the line  $e$   $f$ . Similarly at any point between the middle and the end  $b$ , say at  $g$ , there is a definite negative tension which may be expressed by the line  $g$   $h$ . The same thing may be done for each of the other points in the wire. If the wire is quite uniform, the positive tension decreases quite regularly from the end  $a$  to the middle, and in the same way the negative tension decreases quite regularly from the end  $b$  to the middle. Uniting the ends of the lines which

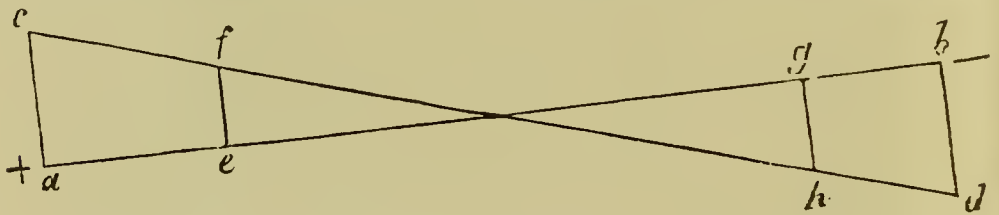

FIG. 41. THE FALL IN THE ELECTRICITY.

thus express the tensions, the result is an oblique straight line which cuts the wire in the centre, and the distance of which from the wire at any point represents the tension at that point.

This regular decrease in the tensions prevailing in the wire may be shown by means of an electrometer, if the latter is brought into contact with each point in the wire. The gradual decrease of the tensions in the wire is evidently also the essential cause of the movement of the electricity through the wire, for at each point in the wire there are adjacent portions in which the tensions gradually become less from left to right, so that the electricity is enabled to flow from left to right. The case is evidently like that of a tube through

which water flows, for in that case also the pressure of the water gradually and regularly decreases from one end to the other. To express this similarity we will apply to electric currents a term borrowed from flowing liquids, and will call the gradual decrease in the tension *the fall in the electricity*.

Let us compare two wires of the same thickness, but of unequal length,  $a b$  and  $c d$  (fig. 42). If  $a b$  is inserted between the poles of a chain, the fall is represented by the oblique line  $e f$ . Supposing  $a b$

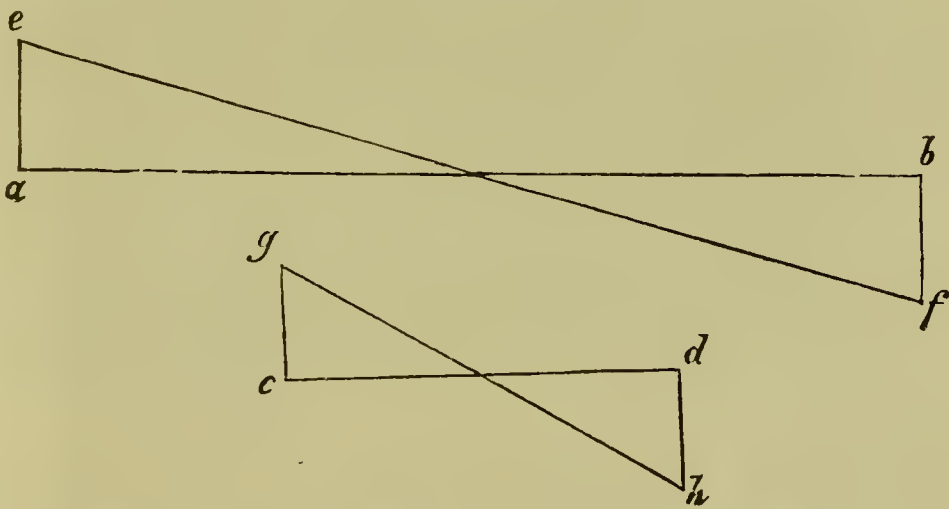

FIG. 42. THE ELECTRIC FALL IN DIFFERENT WIRES.

removed, and  $c d$  inserted between the poles of the same chain, the tensions at the ends would be the same, so that the fall in the case of the wire  $c d$  may be represented by the oblique line  $g h$ . It will be observed that in the case of the shorter wire the line runs much more abruptly, the fall is greater, and the current of electricity advances much more rapidly in this wire. Assuming now that the two wires  $a b$  and  $c d$  are simultaneously attached to the poles of the chain, in this case also the tensions at the two ends must be equal, but the fall must be different. Supposing that

instead of these two wires a number of separate wires are used, then the same thing happens; and if the wires are welded together into a common conducting body, this does not essentially alter the conditions of the fall, so that we may imagine the whole body to consist of these separate wires, in each of which a definite fall, the steepness of which depends on the length of the particular wire, prevails. These wires are, however, merely paths along which the electric currents pass, and of which we have already spoken. In the case of these paths also definite falls must prevail, and these must be more steep in proportion as the points at which the electric currents enter and make their exit are nearer together.

9. Let us return to the case of a simple wire through which a current passes. On uniting two points in this with two electrometers, these exhibit varying tensions, and the difference is greater the further the two points are separated from each other. If the points are then connected by a bent wire, it is evident that the different tensions at the points of contact must effect a disturbance in the natural electricity within the applied wires, and consequently must generate an electric current from the point at which the tension is greater to that at which it is less. If a multiplier is inserted in the applied wire, the needle will be deflected. This is as true of a regular as of an irregular conductor. If in the body *A B* (fig. 43), electricity moves along various paths, and if, as we have seen, different tensions prevail at two points in such a path, a current must arise if the ends of a bent wire are applied to these points, and if the bent wire is supplied with a multiplier the needle will be de-



flected. On the other hand, in two different paths of conduction there must always be points at which the tension is the same. For in each path the tension begins at a certain positive value (at *A*), and passes through a value = 0 to a certain negative value (at *B*). The needle of the multiplier must, therefore, remain at rest if the two ends of the wire of the multiplier are

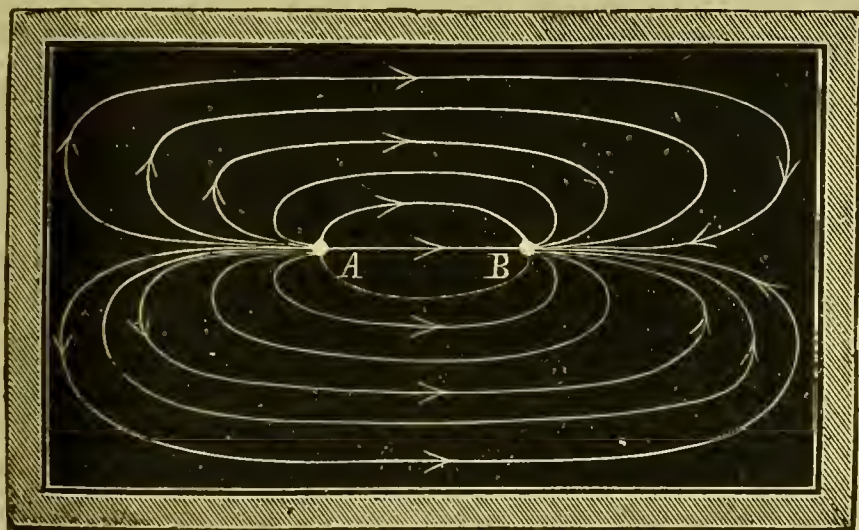

FIG. 43. PATHS OF ELECTRICITY IN A CONDUCTOR.

applied, not to two points of different tension, but to two points of equal tension. This enables us to observe whether in any body in which electric currents move in any form, two points have similar or dissimilar tension, and by systematic experiments of this kind we shall evidently gradually obtain an insight into the form and relative position of the paths of conduction within the body examined.

## CHAPTER X.

1. Diverting arches; 2. Current-curves and tension-curves; 3. Diverting cylinders; 4. Method of measuring tension differences by compensation.

1. If the two ends of a bent wire are applied, in the way described in the last chapter, to any conductor which is traversed by currents, then part of the currents present in the conductor may flow through this wire. Part of the current is, as it were, conducted out of the body in order to facilitate its examination. Under certain circumstances this may cause an alteration in the conditions of the currents within the conductor. We will, however, assume that this is not the case, but that the tensions at the points at which the wire is applied to the conductor are not altered.<sup>1</sup> The direction and strength of the current which arises in the conductor will then depend only on the differences in tension at the point of contact, and on the resistance offered by the wire.

A wire of this sort applied to a conductor traversed by currents is called a *diverting arch*; the ends of the wire with which it touches the body to be examined are called the *feet of the arch*; and the distance between these feet is called the *distance of tension*.

<sup>1</sup> The circumstances under which the exceptions occur cannot be explained here; yet matters may be so arranged that such exceptions do occur.

The further nature of the arch does not matter. It may consist of one or more wires, and it may or may not include moist conductors. Only one condition must be fulfilled: no electric actions must be caused by the contact of the diverting arch with the conductor which is to be examined. Now, we have already seen that this is unavoidable when metallic wires are applied to moist animal substances. The ends of the wire of the arch must, therefore, be connected with the zinc diverting-vessels described above (fig. 38). In this arrangement the clay shields, saturated with a salt-solution, represent the feet of the diverting arch. Such an arch, which neither in itself nor by its application to the conductor under examination affords any cause for the generation of currents, is an homogeneous arch.

In order to attain a thorough knowledge of the distribution of tensions in a conductor, it would apparently be necessary to touch all points of the latter in turn with the feet of the diverting arch. This is easily done in the case of the surface of the body, but as regards the inner parts it is hard and often impracticable. We must therefore rest satisfied with an examination of the surface; but it may be shown that trustworthy conclusions as to the character of the inner parts may be drawn from this study of the surface.

2. Two cases must be distinguished. Either the body to be examined is in itself incapable of electric action, and the electric currents, the internal distribution of which is to be examined, are imparted to it from external sources; or electromotive forces are situated within the body itself, and it is the currents generated by these which form the object of research.



The case of organic tissues, with which we are concerned, is of the latter sort; for we have seen that when these are inserted between the ends of a homogeneous arch, electric action takes place under certain circumstances. The fact that in other cases no such action occurs will be intelligible after the account just given, for we may assume that in such cases the two points which are touched by the ends of the arch are similar in tension.

Let  $BCDE$  (fig. 44) represent a section through

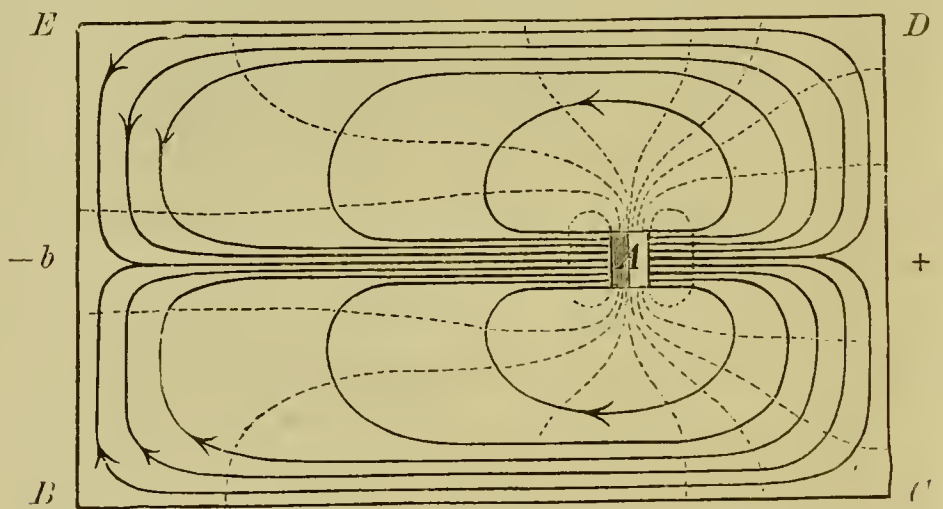

FIG. 44. CURRENT-CURVES AND TENSION-CURVES.

a body in which an electromotive force is present. For the sake of simplicity we will assume that the body is a regular cylinder, and that the electromotive force is situated in its axis; then that which we show in the case of  $BCDE$  will be equally true of every other section. Let the point  $A$  represent the seat of electromotive force<sup>1</sup> which sets the positive electricity in motion toward the right, the negative electricity toward the left. The whole body is then occupied by

<sup>1</sup> In order to have a physical basis for this electromotive force we may imagine the cylinder to consist of a fluid, and that at the point  $A$  is situated a body consisting half of zinc, half of copper.

current-paths. We naturally think of these paths within the cylinder as planes, so that we obtain current-planes, which enclose each other like the scales of an onion, and which in the section which we figure form closed curves all of which pass through the point  $A$ . They are represented on the figure by unbroken lines. On each of these paths a definite fall prevails, as we know—that is, in each of these the point immediately on the right nearest to  $A$  is the most positive, the tension gradually decreasing toward and up to the middle, where it = 0, then becomes negative, the greatest negative tension being immediately next to  $A$  on the left. This is true of all paths or lines of conduction. In each there is a point at which the tension = 0; on the right of this the tension = + 1; yet further to the right it = + 2, and so on up to the greatest tension at  $A$ ; and similarly in each curve, to the left of the zero point there are points at which the tension = - 1, - 2, and so on. If all the points of equal tension are united, the result is a second system of curves, which are at right angles to the current curves, and which are represented in our figure by dotted lines. There is a curve which unites all points at which the tension = 0, another which unites those points at which the tension = + 1, and so on. These may be called *tension-curves* or *iso-electric curves*. In the cylinder the section of which is here drawn, these curves evidently represent planes which cut the planes of the currents already mentioned, and which may be called *tension-planes* or *iso-electric surfaces*. On the outside of the cylinder these iso-electric surfaces are exposed, and meet the surface in bent lines, which in the simple figure which lies before us are all parallel, that is, surfaces

which cut the surfaces of the cylinder parallel to the surfaces of its ends. The iso-electric surface representing a tension = 0, cuts the cylinder near its centre, and divides it into two unequal halves, of which the right is positive, and the left negative. The other iso-electric curves cut the surfaces of the cylinder in parallel curved lines; and the iso-electric curves representing the greatest positive and the greatest negative tensions meet the surfaces at the central points of the end surfaces of the cylinder which, in the figure given, are marked + *b* and - *b*.

The conditions are not always as simple as in this case. If the body under examination is not a regular cylinder, and if the electromotive force is not situated exactly in its axis, then the arrangement of the iso-electric surfaces is more complex. The body under examination is, however, always occupied by a system of current-planes inserted one within the other, and a system of iso-electric surfaces can be constructed which cut the outer surfaces of the body in curves of one form or another. Along each curve of the outer surface corresponding with an iso-electric surface the same tension always prevails; on two of these curves if adjacent the tensions always differ. Regarding therefore only the surface, it may be said that if an electromotive force is present within the body, this must correspond with a definite arrangement of tensions on the surface of the body. By studying this superficial arrangement of the tensions we may therefore draw conclusions from this as to the situation of the electromotive force within the body.

3. The diverting vessels (fig. 38) above described are not always sufficient for the purposes of research.



Apart from the fact that the insertion of the animal substances between the pads cannot always be conveniently managed, it is impossible to bring individual points of the substance into contact with the pads. This does not matter at all when the iso-electric curves run parallel to each other, as in the case described in § 2, on the outer surface of the cylinder. In such cases it is always sufficient to apply the sharp edges of the clay discs to the surface in such a way that all the points which come in contact with these edges belong to the same iso-electric curve. But even in observations on

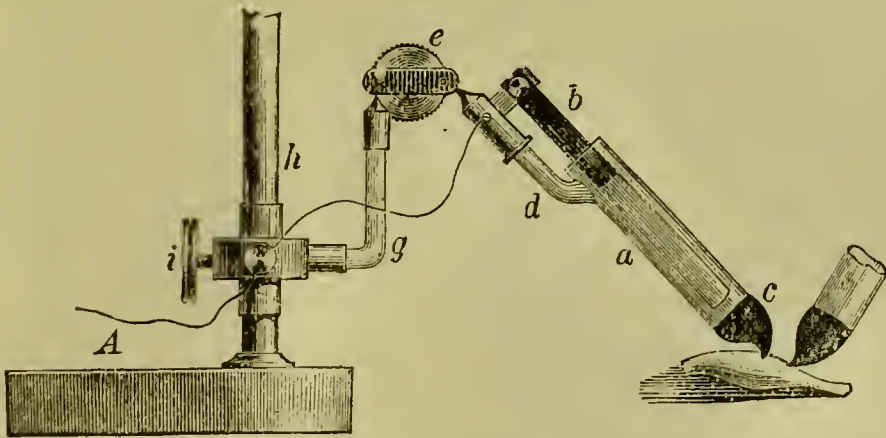

FIG. 45. DIVERTING CYLINDERS AS USED BY E. DU BOIS REYMOND.

the surfaces of the ends of the cylinder the case is different. Here the iso-electric curves form concentric circles. In such cases it is absolutely necessary to carry out with somewhat greater accuracy the theoretic condition that the diverting arch should touch the conductor which is to be examined at two points. Another form of diverting apparatus, invented by du Bois-Reymond, is used both for this purpose and for conducting currents to the body under examination in cases where it is important to avoid electrical polarisation. These, which are usually called *unpolarisable electrodes*, are represented in fig. 45. The glass

cylinder *a*, somewhat flattened, is attached to the stand *A*. The socket *e* and the motor apparatus on the column *h* allow the glass cylinder to be placed in any desired position. Within the cylinder is a strip of amalgamated sheet zinc *b*, which can be connected with the multiplier by means of a wire. The glass cylinder is closed below with a stopper of plastic clay moistened with a solution of common salt, the projecting ends of which can be moulded into a point which touches the smallest possible point on the conductor to be examined. The space within the glass cylinder is filled with a concentrated solution of sulphate of zinc, and thus forms an unpolarisable and homogeneous conductor between the strip of zinc and the clay point. A second and exactly similar apparatus, which is only partly represented in the figure, provides for the diversion from the other point of the conductor.

Whatever form of diverting apparatus is employed, the determination of the fact whether the two points touched by the feet of the diverting arch have like or unlike tension will be more accurate the more sensitive is the multiplier which is inserted in the diverting arch. By placing the body to be examined in such a way that the various points in its surface successively lie on the pads of the above-described diverting vessel (see ch. ix. § 5), or by touching them with the ends of the diverting cylinder just mentioned, it may be discovered which points have equal tension (for in such cases the multiplier will indicate no deflection), or, if the points touched are unequal in tension, it may be discovered at which the positive tension is greatest. For, from this latter point a current must pass through the multiplier to the point at which the positive tension is

less (or, in other words, the negative tension is greater), a fact which can be recognised by the direction of the deflection exhibited by the multiplier. In order, however, thoroughly to understand the position of the iso-electric curves, it would also be necessary to know the absolute amount of the iso-electric tension at each point. Instead of this, however, it is sufficient to determine the difference between the tensions at each two points, which may be found by very accurate and trustworthy methods.<sup>1</sup>

4. To calculate these differences from the extent of the deflection of the multiplier would, for reasons which cannot here be further explained, be very inconvenient and would afford very inaccurate results. But these differences may be measured with quite sufficient precision by a method invented by Poggendorff and afterwards improved by du Bois-Reymond.

If it is required to determine the weight of any body, the latter is placed in one of a pair of scales, and weights are placed in the other until the two are again in equilibrium. As in this case the action of the two weights on the beam of the scales is to raise each other up, they must be equal. This well-known principle is, however, capable of an important generalisation. It is, for example, required to determine the attraction exercised by a magnet on a piece of iron. The iron is attached to one end of the beam of the scales, weights to the other, till the beam is again balanced. The magnet being then placed under the iron, the balance of the beam is again disturbed by the magnetic attraction, and weight must be added to the other scale before it is restored. It is evident that the

<sup>1</sup> See Notes and Additions, No. 10.



amount of weight required for this latter purpose affords a measure of the force of attraction between the iron and the magnet.

In the present case a certain deflection in the multiplier results from the difference in tension at the feet of the diverting arch. It is required to measure the difference. If it is in any way possible to influence the deflection of the multiplier in an opposite direction, and exactly to such a degree that the multiplier no longer indicates any deflection, then the two influences must

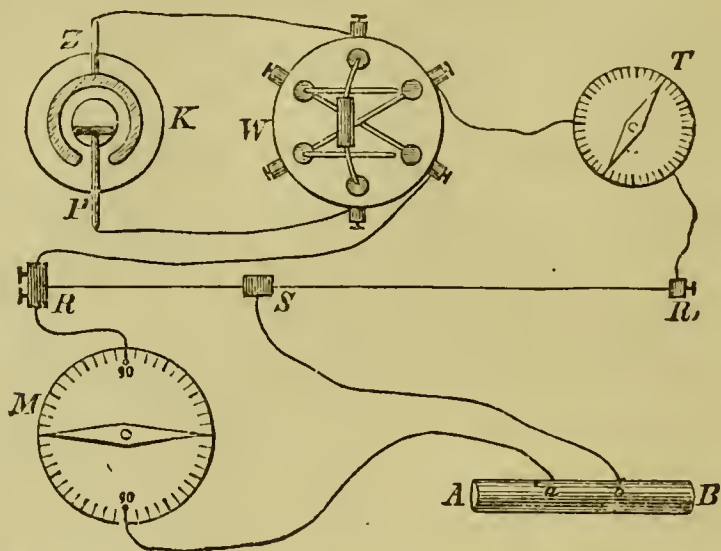

FIG. 46. MEASUREMENT BY COMPENSATION OF THE DIFFERENCE OF TENSION.

be equal, and the one may serve as a measure for the other. The experiment indicated in these instances is called *measurement by compensation*. In order to apply it to the case in point, the action of one difference of tension is cancelled by that of another which may be altered at will. The rheochord, which has already been described, affords a convenient means of doing this.

Let  $R R'$  (fig. 46) be a wire extended in a straight line (the line of the rheochord) through which a current is

passed from the apparatus  $K$ .  $W$  indicates an arrangement by which the current of this apparatus may be made to pass as desired either from  $R$  to  $R'$  or in the opposite direction.  $T$  is a multiplier by the deflection of which proof may be obtained that the current of this apparatus remains constant in its strength. The other parts given in the figure we will for the present disregard. According to what we have already seen (ch. ix. § 7) a definite electric fall must be present in the rheochord. Let us assume that the current passes from  $R'$  to  $R$ , that the tension at  $R = 0$ , and that it increases toward  $R'$ . As the rheochord line is entirely homogeneous, this increase must take place quite regularly; i.e. the tension at every point of the chord must be proportionate to the distance of that point from  $R$ . Now let us imagine that a body,  $A B$ , within which an electromotive force is present, is to be examined. Naturally two points on its surface,  $a$  and  $b$ , have different tensions, and it is this difference which is to be measured. The point  $a$  must be united by means of a wire (in which is inserted as sensitive a multiplier as possible) with  $R$ ; the point  $b$  must be connected by a wire with a sliding-piece  $S$  which moves on the rheochord line. Two differences of tension now act on the multiplier. Firstly, the differences of tension between the points  $R$  and  $S$  of the rheochord; and, secondly, that between the points  $a$  and  $b$ . If at  $b$  there is a greater positive tension than at  $a$ , then the two differences of tension are opposed in action.<sup>1</sup> As the

<sup>1</sup> If the positive tension were greater at  $a$  than at  $b$ , then it would be necessary to reverse the direction of the current within the rheochord. The commutator  $W$  is therefore inserted to effect this reversal of the current.

difference in tension between  $R$  and  $S$  can be altered by changing the position of  $S$ , the slide  $S$  may be placed in such a position that the two influences exactly balance each other, or, in other words, in such a position that the multiplier indicates no deflection. Thus it is evident that

$$S - R - \frac{b - a}{\text{Difference in tension at the two points of the conductor.}} = 0$$

or  $S - R = b - a$ ;

the difference, that is, of the tension between  $b$  and  $a$  is equal to the difference of tension between  $S$  and  $R$ .

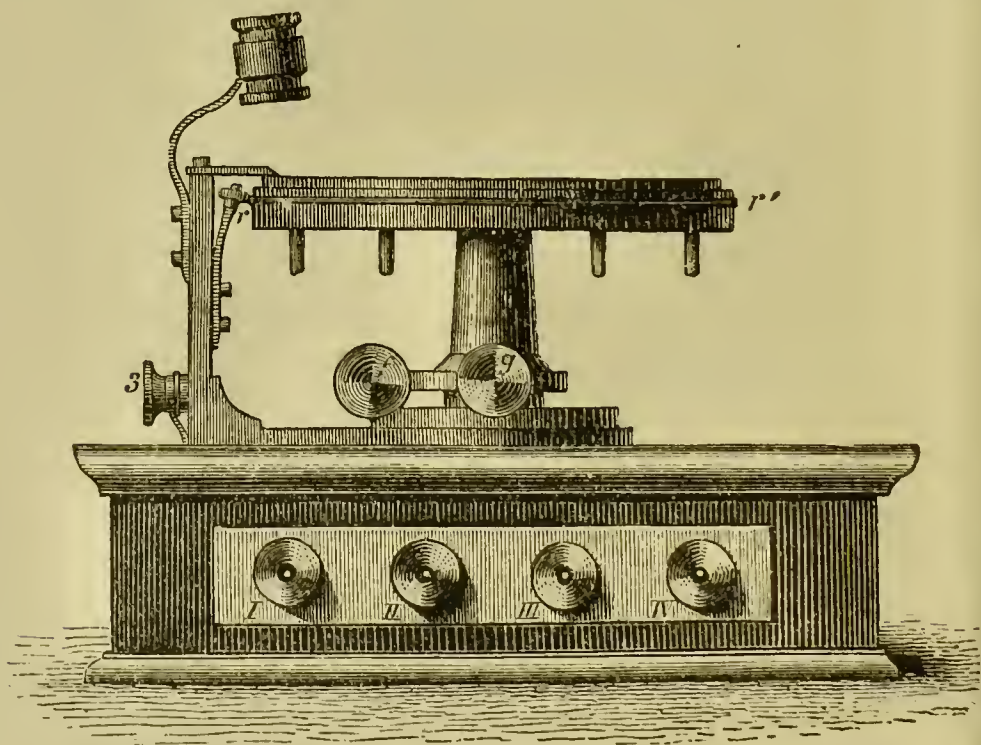

FIG. 47. DU BOIS-REYMOND'S ROUND COMPENSATOR.

The latter is expressed in millimetres, each of which indicates a certain constant amount when a definite rheochord wire is used, and when the current which is conducted through the latter is of a definite strength.

To facilitate measurements of this kind, du Bois-



Reymond invented a 'round compensator' (fig. 47), in which the wire of the rheochord  $r r'$  is placed on the circumference of a circular disc of vulcanised india-rubber. The beginning and the end of the wire are connected

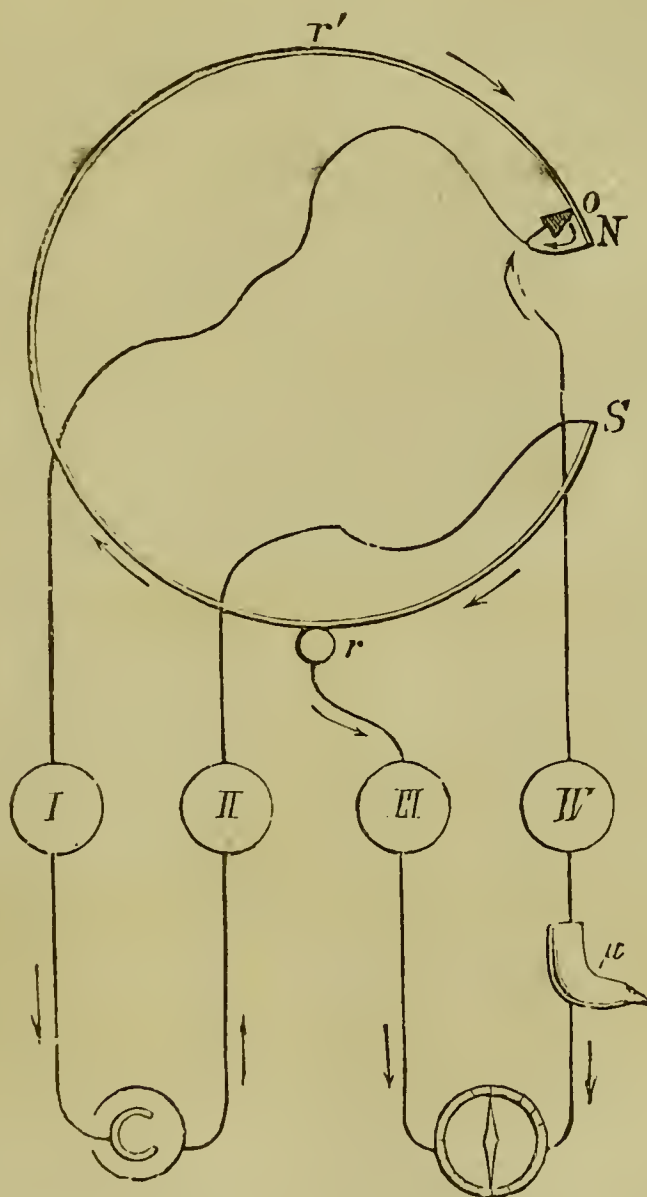

FIG. 48. DIAGRAM OF ELECTRIC MEASUREMENT BY MEANS OF A ROUND COMPENSATOR.

with the clamps I and II; from the beginning a wire also passes to the clamp IV. The clamp III is connected with the small reel  $r$ , which is pressed by

a spring against the wire, and replaces the slide. By turning the disc the length of the inserted portion of the rheochord is altered.

The whole arrangement is shown more clearly in fig. 48, which may at the same time serve as a diagram of the experiments with muscles and nerves, to which we are now about to turn our attention.  $N r' r S$  is the circular rheochord wire, through which the current of the measuring apparatus passes in the direction of the arrow;  $\mu$  is a muscle, two of the points on the outer surface of which, being connected with the multiplier, afford a current, which is exactly compensated by that portion of the current which branches off from the rheochord at the points  $r$  and  $o$ . The particular length  $o r$  of the rheochord wire at which this exact compensation is accomplished, indicates according to the fixed standard (the degree of compensation) the difference in tension at the particular points on the muscle which are tested. This length may be found by turning the round disc, together with the platinum wire, until the multiplier no longer indicates any deflection. By means of a magnifying glass, the length of the inserted wire, from its commencement at  $o$  to the reel at  $r$ , can be read off on a graduated scale.

## CHAPTER XI.

1. A regular muscle-prism ; 2. Currents and tensions in a muscle-prism ; 3. Muscle-rhombus ; 4. Irregular muscle-rhombi ; 5. Current of *m. gastrocnemius*.

1. Beginning the study of the electric phenomena exhibited in animal tissues with muscles, we will at first experiment only with single, extracted muscles. Even these, however, exhibit phenomena so complex in some respects, that it will be better to take first a comparatively simple case. In taking one not exactly under natural conditions—if, that is, we use a muscle artificially prepared for the purpose of experiment—this proceeding will find ample justification in the greater ease with which we shall thus be enabled to understand the more complex examples which we must afterwards examine.

Taking a regularly shaped muscle, in which the fibres are parallel, we will cut out a part of this by making two even cuts at right angles to the direction of the fibres. A piece of this sort may be called a *regular muscle-prism*. It is, according to the shape of the muscle used, either circular or more oval, or flat and band-like ; its shape makes no difference, and the length and diameter are of equally little account. The only essential point is that all the muscle-fibres are



parallel to each other, and that the two cuts are made at right angles to the direction of the fibres. Fig. 49 diagrammatically represents a regular muscle-prism of this sort. The horizontal stripes represent the separate bundles of the fibres. The outer surface of the prism, which therefore corresponds with the upper surface of the fibres, is called the *longitudinal section* of the prism; and the terminal surfaces, at right angles to the longitudinal section, are the *cross-sections* of the muscle-prism. The lines running at right angles to the direction of the fibres are, as we shall presently find, tension-curves.

A regular muscle-prism such as this exhibits a very

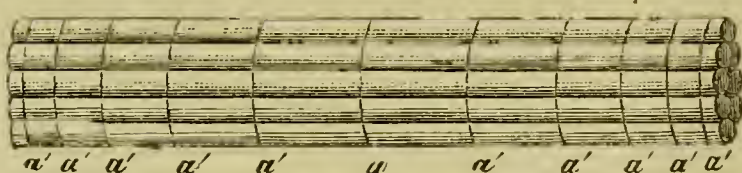

FIG. 49. A REGULAR MUSCLE-PRISM.

simple distribution of tension. All the lines of tension, or the iso-electric curves, run on the surface and are parallel to the cross-sections. Round the middle of the muscle-prism passes a line separating it into two symmetrical halves; this we will call the equator. The *greatest positive tension* to be found anywhere on the surface prevails at this point. Every point on the equator has a greater positive tension than any other point on the longitudinal, or the cross-section. On either side from the equator, the positive tension gradually decreases along the longitudinal section quite regularly in both directions, until, at the point where the longitudinal meets the cross-section, it = 0.

On the cross-sections themselves the tension is

everywhere negative, and the greatest negative tension prevails at the centre of these, and decreases from these points up to where the cross-sections meet the longitudinal section.

2. From this distribution of the tensions it is easy to infer the phenomena which the muscle shows when it is inserted between the pads of the diverting vessels above described, or between the diverting cylinders which represent the feet of the diverting arch. It is evident that no current will result when two points on the equator, or two points on any one of the tension-curves are tested. Nor will any current result when two different points, on either side of the equator, are connected, if these points are equidistant from the equator. Nor will any current result when the two cross-sections are applied to the pads; but, on the contrary, a current will be observed as soon as any point on the longitudinal section and any one on either of the cross-sections are connected, or when two points on the longitudinal section, situated at unequal distances from the equator, touch the pads; or, finally, when two points on the same cross-section, or two points, one on each of the two cross-sections, situated at unequal distances from the central point, are connected. The strongest current will result when a point on the equator is connected with the central point on one of the cross-sections; weaker currents are generated when two unsymmetrical points on the longitudinal section, or two unsymmetrical points on the cross-section are connected. All these cases are represented in fig. 50. The rectangular figure *a b c d* represents a section through the muscle-prism; *a b* and *c d* are transverse sections through the longitu-

dinal section, and  $a c$  and  $b d$  are transverse sections through the cross-section. The curved lines represent the diverting arches, and the arrows show the direction of the currents which are generated in these. No currents are generated in arches 6, 7, or 8, for these unite symmetrical points.

Moreover, the rate at which the tension decreases in the longitudinal section is, not regular, but at a gradually increasing speed from the equator to the ends. If, therefore, we find these iso-electric curves, the

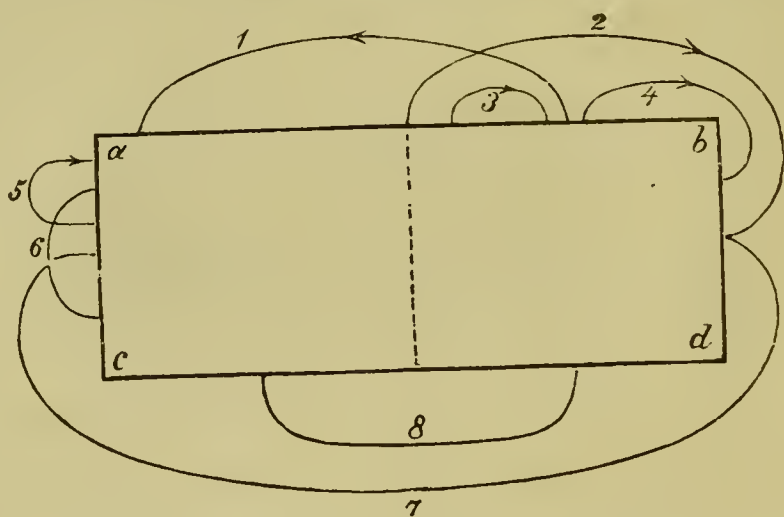

FIG. 50. CURRENTS IN A MUSCLE-PRISM.

tensions of which differ by a definite amount, these, in the centre of the muscle-prism, are at some distance from each other, but gradually approach more closely together toward the edge of the cross-section. If the tension prevailing at each point in one side of a longitudinal section is represented by the height of a straight line drawn at right angles to that side of the longitudinal section, then the curve which unites the heads of these lines is level at the centre of the longitudinal section, but sinks rapidly down toward the edges of the cross-section. A somewhat similar fact is observable on



the cross-sections, where the tension-curves, corresponding with equal differences of tension, are nearer together toward the edge of the longitudinal section than in the middle. If the feet of the diverting arch are equidistant, the currents, both from the longitudinal section and from the cross-sections, are therefore stronger the nearer is the point under examination to the limit between the longitudinal and cross-sections. Fig. 51 shows this circumstance: *A* in the figure represents the tensions on one of the longitudinal sections

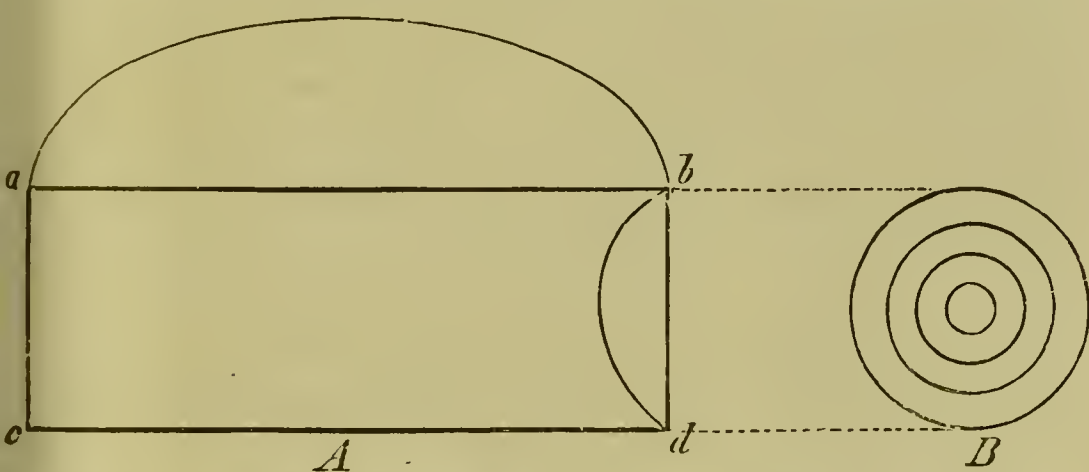

FIG. 51. TENSION ON THE LONGITUDINAL AND CROSS SECTIONS OF A MUSCLE-PRISM.

and on one of the cross-sections of the transverse section represented in fig. 50; while at *B* the tension-curves in a cross-section itself are represented. The latter, if the muscle-prism is perfectly round, are concentric circles. In order to judge of the direction and strength of the current resulting when a conducting arch is applied to any two points of a muscle-prism, it is only necessary to determine the difference of tensions at the feet of the arch, and, in so doing, to notice that when positive tension prevails at one of these points, negative tension at the other, the current through the arch is always in

the direction from the positive to the negative point; but that, if the feet are both positive, or both negative, the current passes from the more to the less positive point, or from the less to the more negative point. From the curves in *A* and *B*, fig. 51, which show the tensions, the currents indicated in fig. 50 may therefore easily be discovered.

3. Once more let us take a muscle, the fibres of which are parallel, and cut a piece out of this, but in such a way that the cross-section, instead of being at right angles to the direction of the fibres, is obliquely directed toward the latter. A piece of this sort may be called a *muscle-rhombus*; if the cross-sections are parallel to each other, it is a *regular muscle-rhombus*; if otherwise, an *irregular muscle-rhombus*. In such a muscle-rhombus, the distribution of the tensions, and, consequently, the form of the iso-electric curves, is much more complex than in a muscle-prism. In this case the curves are not, as in a muscle-prism, parallel, but are sometimes of very complex form.

It is true that in this case also there is the main distinction between the longitudinal section, or outer surface of the muscle-rhombus, and the cross-sections. The former are always positive, the latter negative. But both in the longitudinal and cross-sections a difference is noticeable between the obtuse and the acute angles. The positive tension is greater at the obtuse than at the acute angles of the longitudinal section; and, similarly, the negative tension is greater at the acute than at the obtuse angles of the cross-sections. Consequently, a peculiar displacement of the tension-curves, of which fig. 52 is intended as a representation, takes place in a regular muscle-rhombus.

Let us suppose that the muscle from which the rhombus was cut was cylindrical. The two cross-sections will then form ellipses; in the case of a regular muscle-rhombus, equal ellipses. A section through the longitudinal axes of both these ellipses will therefore give an asymmetrical parallelogram with two obtuse, and two acute angles (a rhomboid). Such a section is represented in the figure. In it,  $a b$  and  $c d$  correspond with the longitudinal section,  $a c$  and  $b d$  the cross-sections. The latter are identical with the longitudinal axis of the actual cross-sections. On the side corre-

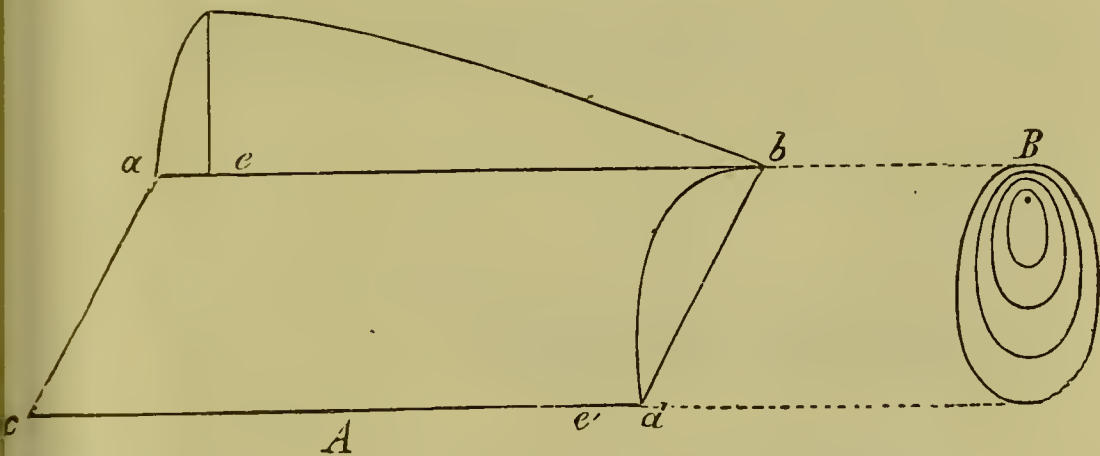

FIG. 52. TENSIONS ON A REGULAR MUSCLE-RHOMBUS.

sponding with the longitudinal section, the greatest positive tension is no longer found in the middle, but is removed toward the obtuse angles, at  $e$  and  $e'$ . The tensions fall very rapidly from here toward the obtuse angle, gradually toward the acute angle. In the cross-sections the greatest negative tension occurs near the acute angles; and the fall toward the acute angles is very abrupt, that toward the obtuse angles is gradual.

The iso-electric curves on such a regular muscle-rhombus in the cross-sections form ellipses, one pole of which corresponds with a focus on the edge of the



cross-section, near the acute angle. In the longitudinal section they form spiral lines, which run obliquely round the outer surface of the cylinder. The electromotive equator, which unites the points at which the greatest positive tension prevails, forms a line round the circum-

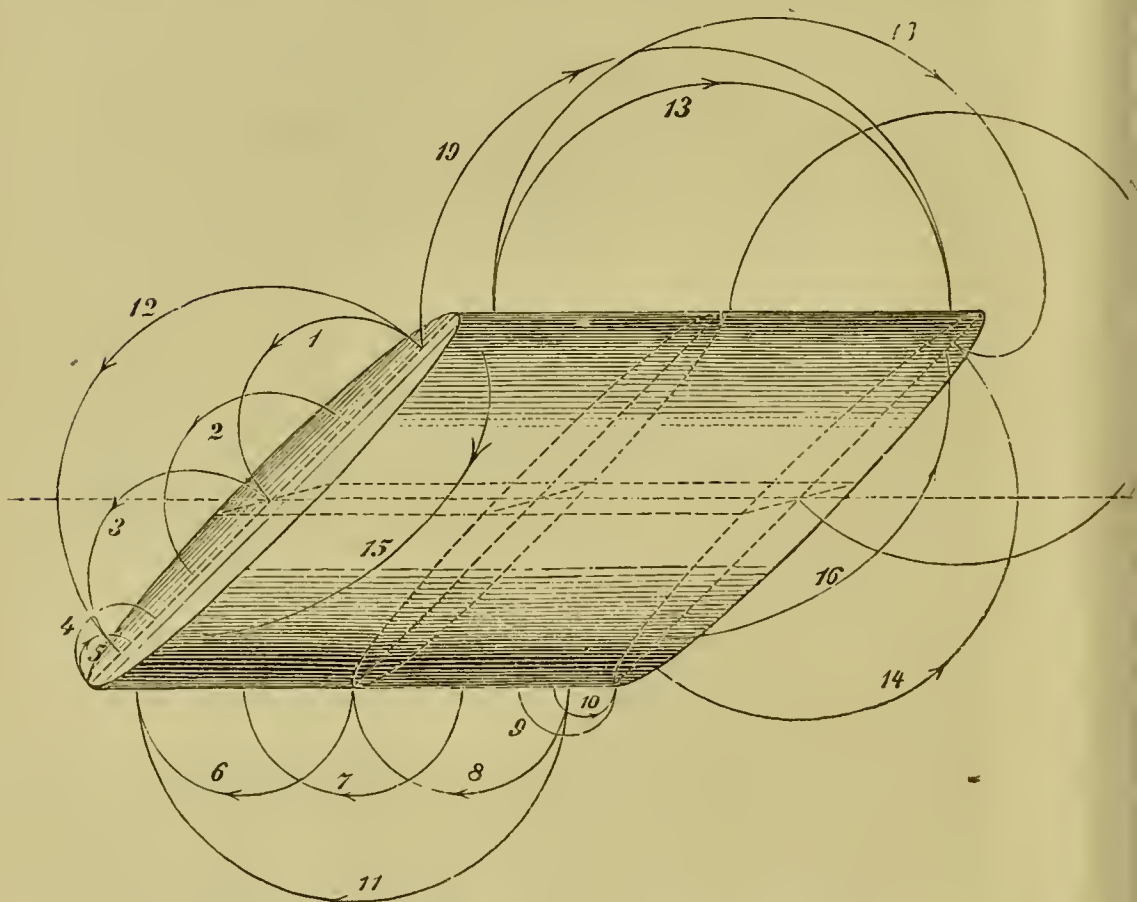

FIG. 53. THE CURRENTS IN A REGULAR MUSCLE-RHOMBUS.

ference, which separates the rhombus into two equal halves.

Supposing that a plane is drawn in such a regular muscle-rhombus, through the small axis of the elliptical cross-sections, a rectangular figure will be obtained. The muscle-fibres lying in such a section are all cut in a similar way, and their condition is exactly alike. Therefore in this section also the greatest tension or

the longitudinal, as on the cross-sections, is situated in the centre, and an arrangement of the tensions exactly similar to that in a muscle-prism is observable.

From what has been said, the direction and strength of the currents which are generated on the interconnection of any points in a muscle-prism by the application of an arch may easily be inferred. They are represented in fig. 53. The direction of the currents in the applied arches is in every case indicated by arrows; where there are no arrows the arch connects two points of equal tension, so that there is no current (e.g. arches 4 and 9). The currents all pass from the obtuse to the acute angle, through the applied arches, except in the fifth and tenth, in which the direction is reversed.

4. The phenomena in irregular muscle-rhombi do not differ essentially from those just described, but the arrangement of the tensions is asymmetrical. Passing to muscles in which the arrangement of the fibres is irregular, it is apparent that each cut made must always meet a part of the fibres obliquely, and that, therefore, the matter just explained must always be borne in mind in explanation of the phenomena, which are sometimes very complex. Not to enter too far into details, we need only say that the same fundamental principle asserts itself in all muscles; everywhere the longitudinal section, as distinguished from the cross-section, is positive; and in all cases there is a point or line in the longitudinal section which is the most positive, and a point in the cross-section which is most negative; so that, if an arch is applied, currents pass through this from the longitudinal to the cross-section, weaker currents between points in the longitudinal section, and

between points in the cross-section respectively. The position of these most strongly positive and most strongly negative points depends on the angles which the fibres form with the cross-sections, and may be found by the rules given in the last paragraph as to the influence of oblique section.

Of all the many muscles of the animal body one claims special attention, because, for purely practical reasons, it is most frequently used in physiological experiments: this is the calf-muscle (*m. gastrocnemius*). It is easily prepared, even without severing its connection with its nerve, a fact which, for reasons presently to be stated, is of great importance. It affords, as we shall see, a powerful current; it long retains its capacity for action; and, in short, it has many advantages by which we were induced, when studying the activity of muscle and the excitability of nerves, to make use of it almost exclusively. As, however, the structure of the muscle is very complex, the nature of its electric action is by no means easily understood. We must, however, describe at least its main outlines, as we must employ the muscle in further important experiments.

In order to understand this action we must previously observe that it is not absolutely necessary to cut a piece out of a muscle, but that entire muscles are also capable of affording currents. In dealing with the muscle-prism and muscle-rhombus, we assumed that the pieces were cut from parallel-fibred muscles. The longitudinal sections of these pieces retained their covering of muscle-sheath (*perimysium*) and, in fact, corresponded with the natural surface of the muscle. The cross-cuts were, however, made into the actual substance of the muscle, so that part of the interior



was laid bare. Such cross-sections may be termed *artificial*, while the longitudinal sections of these prisms or rhombi may be called *natural*. Longitudinal sections may also be formed artificially, by splitting the muscle in the direction of its fibres; and we may speak of natural cross-sections, by which we understand the natural ends of the muscle-fibres while still closed with the tendonous substance. Now the action both of longitudinal and of cross-sections is the same whether they are natural or artificial.<sup>1</sup> It is, therefore, always possible to obtain currents from an uninjured muscle exactly as from artificially prepared muscle-prisms and rhombi.

5. To the circumstance that it can, while still uninjured, afford powerful currents, is due the special importance of the *gastrocnemius*. This muscle may in all essential points be classed among the penniform muscles; though in reality it is thus conditioned only towards its upper tendon, the part toward the lower tendon being rather of the character of a semipenniform muscle. In order to understand its structure, let us imagine two tendonous plates, an upper and a lower, connected by muscle-fibres stretched obliquely between them, so as to form a semipenniform muscle. Now let us suppose the upper tendonous plate to be folded in the middle, as a sheet of paper might be, and that the two folded halves are in apposition. We now have an upper tendon plate, situated within the muscle, from which muscle-fibres pass obliquely in both directions; the lower tendon has, however, been so bent by the folding of the upper so that the whole muscle is shaped like a turnip split in a longitudinal direction, the flat

<sup>1</sup> Exceptions to this rule will presently be mentioned.

surface of which (turned toward the bone of the lower leg) is formed solely of muscle-fibres, exhibiting a delicate longitudinal streak as the only indication of the tendon buried within it; the arched dorsal surface is, on the contrary, clothed, as regards the lower two-thirds of its length, with tendonous substance which passes below into the so-called *tendo Achillis*.

It is evident that such a muscle has naturally an oblique cross-section, represented by this tendonous covering, and a longitudinal section which includes the whole of the flat, and a little of the curved portion. This muscle can, therefore, without any further pre-

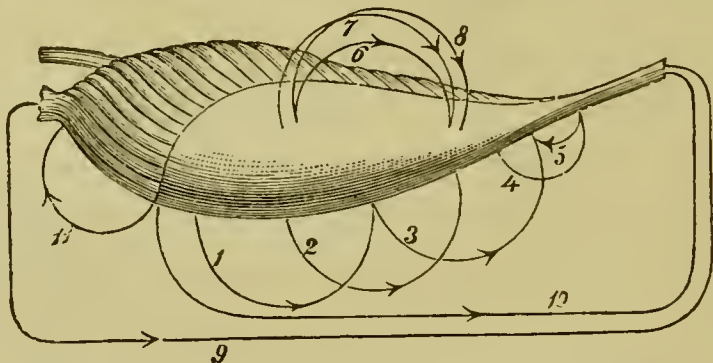

FIG. 54. THE CURRENTS OF A GASTROCNEMIUS.

paration afford currents; for which reason it may be most advantageously used in a large number of experiments.

Regarding once more the structure of the *gastrocnemius*, as it has just been described, a natural longitudinal section is recognisable in the whole flat part and a little of the upper portion of the curved surface; and a natural cross-section is to be recognised in the greater and lower part of the curved upper surface. No second cross-section exists in this muscle, for the upper tendon is buried within the muscle. The currents which the muscle sends through an arch applied so as to connect

different points on its outer surface will now easily be understood, and are as represented in fig. 54. It is most especially necessary to notice that a strong current must be generated on the interconnection of the upper with the lower end of this muscle, and that the current within the arch is directed from the upper to the lower end of the muscle. The upper end must be strongly positive; for it represents the middle of the longitudinal section. The lower end must be strongly negative; for it is the acute angle of an oblique cross-section. There are very few points so alike in the matter of tension that no current results from their connection. A case of this kind is, however, shown in the fourth arch.



## CHAPTER XII.

1. Negative variation of the muscle-current ; 2. Living muscle is alone electrically active ; 3. Parelectromy ; 4. Secondary pulsation and secondary tetanus ; 5. Glands and their currents.

1. The powerful current afforded by an entire *m. gastrocnemius* enables us to answer the important question as to the *character of electric phenomena during contraction*. All that is necessary is to prepare this muscle, together with its nerve, and to insert its upper and lower ends between the pads of the diverting vessel already described, and then to place the nerve on two wires so that it can be irritated by inductive currents ; it must then become evident whether the activity of the muscle has any influence on its electric action or not.

In order to carry out the experiment, let us suppose the muscle, as shown in fig. 55, placed between the pads of a diverting vessel, these pads being brought somewhat near each other, so that the contact of the muscle with the pads is not disturbed by the contraction of the former. The nerve, which has been extracted with the muscle, is laid on two wires which are connected with the secondary spiral of the inductive apparatus. A key, inserted between the nerve and the spiral, regulates the inductive currents so that the nerve is not excited. When all is arranged, and the multi-

plier has assumed a fixed deflection, the extent of which depends on the strength of the muscle-current, the key at *S* is opened. Inductive currents pass through the nerve, and the muscle contracts. At the same instant the deflection of the multiplier is observed to decrease. If the irritation of the nerve is interrupted, the deflection of the multiplier again increases; and when the irritation is again commenced, it again decreases, and this process continues as long as the muscle continues to afford powerful contractions.

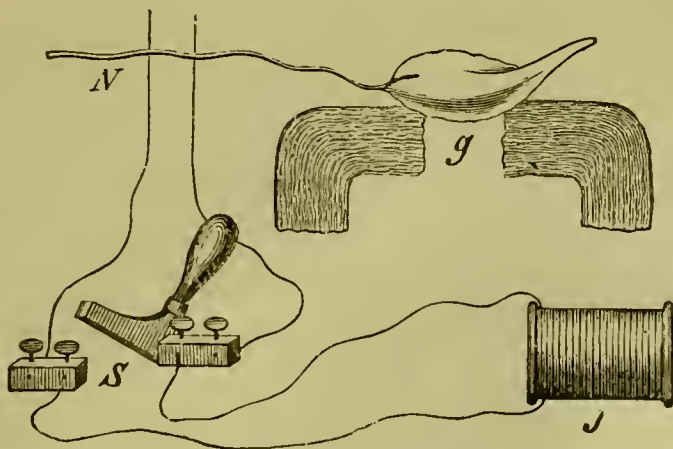

FIG. 55. THE MUSCLE-CURRENT DURING CONTRACTION.

This experiment, therefore, shows that the current of the *gastrocnemius* is weakened during contraction. This may be most strikingly shown by a variation of the experiment just described. After the muscle has been placed in position and a deflection of the multiplier has been caused, the muscle-current may be compensated, as described in Chapter X. § 4. Two currents, equal but in opposite directions—the current of the muscle and that of the compensator—now, therefore, pass through the muscle and cancel each other. As long as these two currents are equal, no deflection can occur in the multiplier. When the nerve is then irri-

tated and the muscle contracts, the current becomes weaker; the current afforded by the compensator thus gains preponderance, and effects a deflection which is, of course, in exactly the opposite direction to that which was originally effected by the muscle.

There is strong reason to believe that this alteration in the strength of the muscle-current really depends on the activity of the muscle and is not occasioned by any accidental circumstances. Any form of irritant may be used indifferently to effect this activity. Chemical, thermal, or other irritants may be used in place of electricity to irritate the nerve; or the experiment may be made on a muscle which is still in connection with the whole nervous system, and the contraction may be effected by influences acting through the spinal marrow and the brain. But the result is always the same. Even when external circumstances entirely prevent contraction, the irritated muscle, without changing its form, exhibits this decrease in its current as soon as it is brought into the condition of activity by irritation. If, for example, care is taken that the muscle retains its form unaltered, by fastening it in a suitable clamp, and if this muscle is then irritated into activity, the current decreases in exactly the same way as when the experiment is carried out as before described.

It is an especially interesting fact that this same phenomenon may also be observed in the muscles of living and uninjured men. It is very hard to prove that the electric action of muscles of living animals in their natural position is exactly the same as that of muscles when extracted; but the fact that on contraction exactly the same electric processes occur in muscles whether they are in their natural position or have been



extracted is quite certain. E. du Bois-Reymond showed this in the human subject in the following way. The ends of the wire of the multiplier are connected with two vessels filled with liquid, and the index finger of both hands is dipped in these vessels, as in fig. 56.

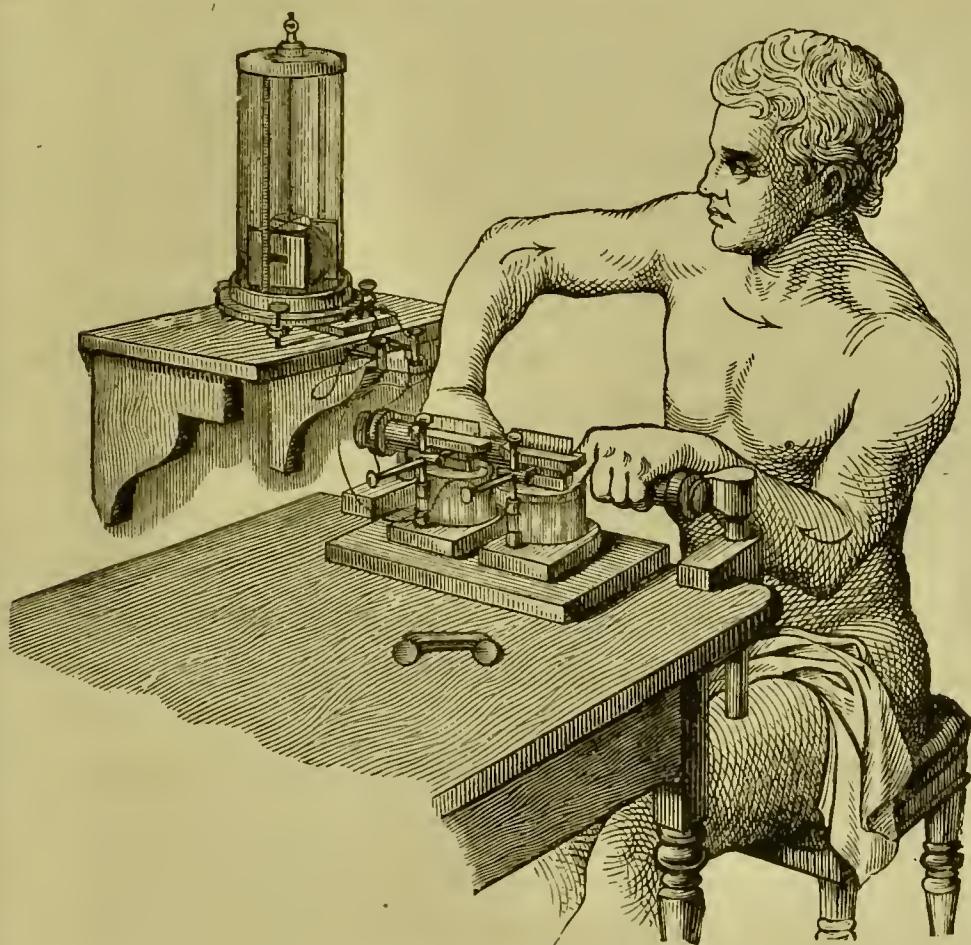

FIG. 56. DEFLECTION OF THE MAGNETIC NEEDLE BY THE WILL.

A rod arranged in front of the vessel serves to steady the position of the hands. Currents are then present in the muscles of both arms and of the breast, which, since the groups of muscles are symmetrically arranged, cancel each other, acting one on the other. If for any reason any current remains uncanceled, it may be compensated in the way before described. When all is thus arranged, and the man strongly contracts the

muscle of one arm, the result is an immediate deflection of the multiplier, which indicates the presence of a current ascending in the contracted arm from the hand to the shoulder. If the muscles of the other arm are contracted, a deflection occurs in the opposite direction. We are, therefore, able by the mere power of the will to generate an electric current and to set the magnetic needle in motion.

Summing up all that has been said, it appears that, during muscular contraction, the electric forces acting in the muscle undergo a change which is independent of the alteration of form in the muscle, and is connected with the fact of activity itself. As, during this alteration, the current which may be exhibited in an applied arch becomes weaker, the term *negative-variation of the muscle-current* has been applied to it.

2. The negative variation of the muscle-current on contraction, as described in the last paragraph, is a proof of the fact that in the electric action of muscle we have to do, not with an accidental physical phenomenon, but with an action very closely connected with the essential physiological activities of muscle. It is therefore worth while to trace an action of this sort more accurately, as it may possibly aid in the explanation of the activity of the muscle.

It may, in the first place, be safely asserted that all muscles of all animals, as far as they have at present been examined, exhibit the same electric action. Even smooth muscles act electrically in the same way; though in that case the phenomena are less regular, owing to the fact that the fibres are not so regularly arranged as in striated muscle. Moreover, the electric activity of smooth muscles seems to be somewhat weaker.

Further, it is to be observed that the electric activity of muscles is connected with their physiological power of accomplishing work. When muscles die, the electric phenomena also become weaker, and finally cease entirely when death-stiffness intervenes. Muscles which can no longer be induced to contract even by very strong irritants may indeed still show traces of electric action; but this power soon disappears. Nor does the electric activity, when it has once disappeared from a rigid and dead muscle, ever, under any circumstances, return.

Although it may be assumed as proved that the electric activity of muscle is connected with the living condition of the muscular tissue, it must not, however, be inferred from this that this activity is necessarily always present during life. It is conceivable that the preparation necessary for the study of electric action (the exposure of the muscle, its connection with the arch, &c.) might produce changes in the living muscle which are themselves the cause of electric activity. To satisfy this doubt it would be necessary to show the previous existence of electric activity, wherever it is possible, in uninjured men and animals. The great difficulty which lies in the way of such proof has already been mentioned. The more complex is the arrangement of the fibres and the position of the separate muscles present in any part of the body, the harder is it to say, *à priori*, how the separate currents of the various muscles combine. It must also be added, that the skin, through which the electric action is necessarily observed, is in itself somewhat electrically active,<sup>1</sup> and that, in other ways also, it increases the difficulty of proving the

<sup>1</sup> These skin-currents will be again mentioned.



presence of muscle-currents. Due regard being had to all these circumstances, the conclusion may yet be drawn that entirely uninjured muscles situated in their natural position are in themselves electrically active. It is true that this has been repeatedly denied by many observers. Our reason for reasserting it is that the explanation of the phenomena on the assumption of the absence of electromotive opposition in uninjured muscle necessitates very forced and complicated assumptions, while our view is able to explain all the known facts very simply and in a thoroughly satisfactory manner.

3. The electric action of muscles which, though extracted, are otherwise uninjured, is often very weak, and is sometimes even reversed; that is to say, the natural cross-section is not negative, but positive, in opposition to the longitudinal section. This condition is found chiefly in the muscles of frogs which have been exposed during life to severe cold. It is, however, only necessary to remove, in any way, the natural cross-section with its tendonous covering, in order to elicit action of normal character and strength. In parallel-fibred muscles it is often necessary to remove a short piece, of from 1 to 2 mm. in length, from the end of the muscle-fibres, before meeting with an artificial cross-section in which the action is powerful.

This phenomenon, which was called *parelectronomy* by E. du Bois-Reymond, because it differs from the usual electric action of muscles, gave rise to that explanation of the electric phenomena according to which the electric opposition between different portions of the muscle is not present in the normal muscle, but only intervenes on the exposure of the muscle. The difficulty mentioned above, of showing the muscle-currents

in uninjured animals, lent force to this explanation. Yet no sufficiently strong proof of this view has been brought forward to cause us to doubt the existence of electric action in uninjured and living muscles.

The question does not, however, essentially affect the physiological conception of the relation of this activity to the other vital qualities. It is unimportant whether the separate portions of the outer surface of a muscle are similar or dissimilar in the matter of tension. The only essential point is, as to whether electromotive forces are present within the muscle, and whether these are in any way related to the physiological work of the muscle. Negative variation has a deeply important bearing on this question, so that we will, after this digression, return to a more detailed study of this phenomenon.

4. It is unnecessary to tetanise the muscle in order to exhibit negative variation. If a sufficiently sensitive multiplier is used, a single pulsation suffices. Even without a multiplier, negative variation may be very well shown in the following way.

On a *gastrocnemius* prepared with its nerve (fig. 57), or on an entire thigh (*B*, fig. 58), the nerve of a second *gastrocnemius*, or thigh, *A*, is placed in such a way that one part of the nerve touches the tendon, another part touches the surface of the muscle-fibres. The nerve then represents a sort of applied arch, uniting the negative cross-section and the positive longitudinal section, and a current, corresponding with the difference of tension at these points of contact, passes through the nerve.<sup>1</sup>

<sup>1</sup> This current may at the moment of its generation, i.e. on the sudden application of the nerve, exercise an irritating effect on the nerve and may elicit a pulsation of the muscle. This is the

If the nerve of the muscle *B* is then irritated, either by closing or by opening a current, by an inductive shock, by scission; by pressure, or in any other way, the muscle *A* is observed to pulsate also. This is called *secondary pulsation*. The explanation is easy. The muscle-current from *B* during its pulsation suffered a negative variation. This variation took place also in that portion of the current which passed through the applied nerve; and, as every nerve is irritated by sudden change

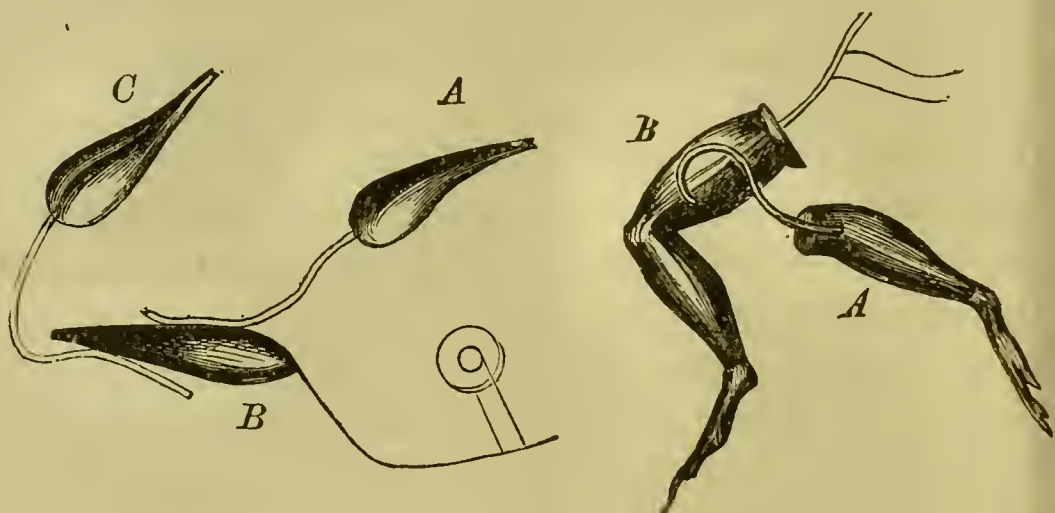

. FIG. 57 & 58. SECONDARY PULSATION.

in the strength of the current, the result was a secondary pulsation.

A variation of this experiment is very interesting. The heart of a frog continues to beat for some time after it has been extracted from the body. If the nerve of a muscle is placed on this heart so as to touch its base and point, the muscle pulsates at every beat of the heart. In this case, the heart-muscle affords the muscle-current, the negative variation of which irritates the applied nerve and causes secondary pulsation.

'pulsation without metals' (*Zuckung ohne Metalle*) which has gained celebrity from the writings of Volta, Humboldt, and others.



If the nerve of one muscle is placed on a second muscle in such a way that no observable part of the current passes through the former (as shown in the nerve of the muscle *C*, in fig. 58), no secondary pulsation takes place in the muscle.

If the nerve of the first muscle is repeatedly irritated in such a way that the muscle *B* passes into a state of tetanus, then the muscle *A* assumes the condition of *secondary tetanus*. This important experiment shows that variations of electric activity take place in rapid succession in tetanised muscle. For it is only owing to such rapidly succeeding variations in the strength of the current that a persistent, tetanising irritation can occur in the second nerve. Just as the phenomenon of muscular tone led us to the conclusion that muscle-tetanus, though the similarity in external form is apparently complete, is not a state of rest, but that the molecules of the muscle must be in constant internal motion during tetanus, so we now find from the phenomenon of secondary tetanus that throughout its duration a continual variation occurs in its electric condition; and from this we may infer that electric variation is connected with the motion of the molecules which causes contraction.

More detailed study of negative variation has also shown that it occurs even in the stage of latent irritation, that is, at a time at which the muscle has not yet altered its external form in any way. It has also been found that the electric change which occurs on irritation propagates itself when the muscle-fibre is partially irritated at a rate equal to that of the propagation of the contraction (from 3 to 4 m. per second: *cf.* ch. vi. § 5, p. 100). When, therefore, a muscle-

fibre of some length is irritated at one point, an electric change at first occurs only at this point; this continues an extremely brief time, and then runs wave-like along the muscle-fibre; and this electric change is then followed by the mechanical change of contraction and thickening, which is called contraction, and which then propagates itself in a similar wave-like manner. If, however, the whole fibre is irritated at once, the electric change occurs simultaneously throughout the fibre, and this is then followed by the mechanical change.

5. The *glands* are in many points very similar to the muscles, though their structure is so different. A gland of the simplest form is a cavity lined with cells, opening by a longer or shorter passage through the outer surface of the mucous membrane, or the outer skin (*corium*), which lies above it. The cavity may be hemispherical, flask-shaped, or tubular. In the latter case the tube is often very long, and is either wound like a thread, or is coiled, and is sometimes expanded at its closed end in the form of a knob. These are all *simple glands*. *Compound glands* are found when several tubular or knob-shaped glands open with a common mouth. Substances, often of a very peculiar character, are found within the glands, and are secreted on to the outer surface through the mouth. These are the sweat and fat of the skin, which are prepared in the sweat or fat glands of the skin, the saliva and the gastric juice, which, owing to their power of fermentation, play an important part in digestion, the gall, which is formed within the liver, and other substances. The similarity alluded to between the muscles and the glands consists in the dependence of both on the nerves. If a nerve which is connected with a muscle is irritated, the muscle

becomes active, that is, it contracts; and if a nerve which is connected with a gland is irritated, the gland becomes active, that is, it secretes. If, for example, the nerves which pass into a salivary gland are irritated, the saliva may be made to ooze in a stream from the mouth of the gland. It is certainly an important fact that, except muscles (and disregarding the nerves, which will be spoken of in the following chapter), the glands are the only tissue which has been shown to possess regular electric activity. This is not, indeed, true of all glands, but only of the simple forms, the bottle-shaped or skin glands. Wherever a large number of these occur regularly arranged, side by side, it is found that the lower surface, that which forms the base of the gland, is positively electric, while the upper surface, that which forms the exit duct of the gland, is negatively electric. This is best shown in the skin of the naked amphibia, in which glands abound, and in the mucous membrane of the mouth, stomach, and intestinal canal of all animals. In these tissues all the glands are arranged in the same order, side by side, and all act electrically in the same direction.<sup>1</sup> In compound glands, on the contrary, the separate gland elements are arranged in all possible directions, so that the actions are irregular and cannot be calculated.

In the skin-glands of the frog, as in the glands of

<sup>1</sup> These currents of the skin-glands afford one of the reasons to which allusion has already been made (§ 2) why the indication of muscle-currents in living and uninjured animals is beset with difficulties. As the currents of the skin-glands at two points of the skin from which the muscle-current is to be diverted are not always of equal strength, therefore the action of the skin mingles with, and affects that of the underlying muscles, so as to hinder the detection of the latter.



the mucous membrane of the stomach and intestinal canal, it may be clearly shown that the electric force is really situated in the glands. On irritation of the nerves which pass into the skin by which the glands are excited into activity, the gland-current decreases in strength, and exhibits a negative variation, just as the muscle-current decreases when the muscle is excited into activity. In this case, also, a relation therefore exists between the activity and the electric condition: and this adds to the similarity between muscles and glands.

Engelmann tried to explain the secretion of the glands physically, by the electric currents present within them. This must, however, be regarded as not yet sufficiently confirmed to claim further attention in this place.

## CHAPTER XIII.

1. The nerve-current ; 2. Negative variation of the nerve-current ;
3. Duplex transmission in the nerve ; 4. Rate of propagation of negative variation ; 5. Electrotonus ; 6. Electric tissue of electric fishes ; 7. Electric action in plants.

1. In addition to the many points of similarity between muscles and nerves exhibited in their behaviour when irritated, it cannot escape notice that the nerves also exhibit electric phenomena, and that they do this in exactly the same way as does muscle. Nerves being formed of separate parallel fibres, these phenomena are exactly analogous to those in a regular muscle-prism ; only that in a cross-section of a nerve, on account of its small extent, differences of tension cannot be shown at the various points, and the cross-section must be regarded as a single point.

In an extracted piece of nerve all the points on the upper surface, that is, on the longitudinal section, are as a fact positive, in distinction from those on the cross-section, which are all of one kind. On the longitudinal section the greatest positive tension is always in the centre, and the tension decreases toward the cross-sections, just as in the muscle-prism, at first slowly, afterwards more abruptly, as shown in fig. 59.

Because of the small diameter of the nerve-trunks, distinction cannot, of course, be drawn between straight

and oblique cross-sections, such as we made in the case of muscle; nor can phenomena due to the oblique course of the fibres be detected, as in muscle. Where larger masses of nerve-substance occur, as in the dorsal marrow and brain, the course of the fibres is so complex that nothing can be affirmed except that the cross-sections are always negative in distinction from the natural upper surface or longitudinal section.

2. If a current is conducted from any two points on the longitudinal section of a nerve, or from one point on the longitudinal section or one on the cross-section, and if the nerve is then irritated, the nerve-current evidently becomes weaker. It does not matter what form of irritation is used, provided that it is sufficiently strong to cause powerful action in the nerve. It thus appears that in the nerve, as in the muscle, a change in the electric condition is connected with its activity, and that this change is a decrease, or negative variation of the nerve-current. We must now go back to the statement already made (chap. vii. § 2), that the active condition of the nerve is not shown by any change in the nerve itself. We then found it necessary, in order to observe the action of the nerve, to leave it in undisturbed connection with its muscle. The muscle was used as a reagent, as it were, for the nerve, because in the latter neither optical, chemical, nor any other indicable changes could be observed. In its electric qualities we have, however, now found a means of testing the condition of the nerve itself. Whatever view is taken as to the causes of electric action in nerves, it is at least certain that every change in the electric condition must be founded on a change in the nature or arrangement of the nerve substance; and that there-



fore the evident negative variation of the nerve-current is a sign—as yet the only known sign—of the processes which occur within the nerve during activity. This sign, therefore, affords an opportunity of studying the activity of the nerve itself independently of the muscle.

3. E. du Bois-Reymond made an important use of this fact in order to determine the significant question, whether the excitement in the nerve-fibre is propagated only in one, or in both directions. If an uninjured nerve trunk is irritated at any point in its course, two

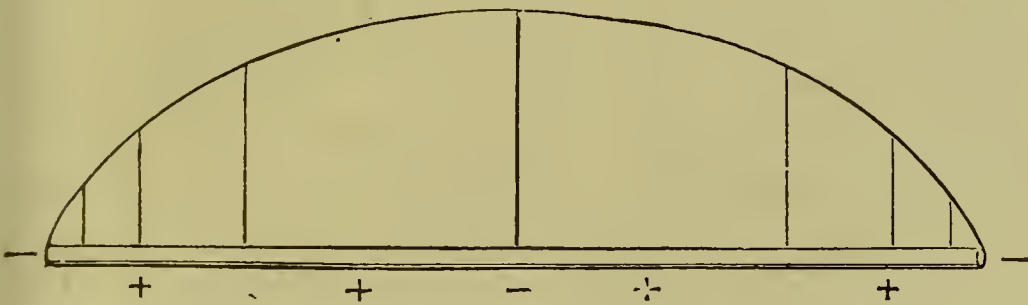

FIG. 59. TENSION IN NERVES.

actions are usually observable; the muscles connected with the nerve pulsate, and, at the same time, pain is caused. The excitement has therefore been transmitted from the irritated point both to the periphery and to the centre, and it exercises an influence in both places. Now, it may be shown that in such cases two different kinds of nerves are present in the nerve-trunk—motor nerves, the irritation of which acts on the muscle; and sensory nerves, the irritation of which causes pain. In some places each of these kinds of fibre occurs separately; and where this is the case, irritation of the one results only in motion, irritation of the other only in sensation. It is evident, therefore, that the experiment in no way determines whether when a motor nerve alone is irritated, the excitement is trans-

mitted only toward the periphery or also toward the centre; or as to whether, when a sensory nerve alone is irritated, the excitement is transmitted only toward the centre or also toward the periphery. For as the sensory nerves do not pass at the periphery into muscles, by means of which their actions could be expressed, there is no means of telling whether the excitement in them is transmitted to the periphery. But our knowledge of the electric changes which occur during activity affords a means of determining this question. For these changes are observable in the nerve itself, independently of the muscles and other terminal apparatus. If a purely motor nerve is irritated, and is then tested at a central point, negative variation is found to occur in this also; and similarly, if a purely sensory nerve is irritated, negative variation may be shown in a part of the nerve lying between the irritated point and the periphery. This, therefore, shows that the excitement in all nerve-fibres is capable of propagation in both directions; and that if action occurs only at one end, this is due to the fact that a terminal apparatus capable of expressing the action is present only at that end.<sup>1</sup>

4. If negative variation in the nerve current is really a necessary and inseparable sign of that condition within the nerves which is called the 'activity of the nerves,' it must, like the excitement, propagate itself within the nerve at a measurable speed. Bernstein succeeded in proving this, and measured the speed at which the propagation occurs. If one end of a long nerve is irritated, the other end being connected with a multiplier, a certain time must elapse before the irritation, and consequently also the negative variation.

<sup>1</sup> See Notes and Additions, No. 11.

reaches the latter end. In ordinary experiments the irritation occurs continuously, and the connection of the other end of the nerve with the multiplier is also continuous. But the time which elapses between the commencement of irritation and the commencement of negative variation is, even in the case of the longest nerves with which experiments can be tried, far too short to allow of observation of this retardation. Bernstein proceeded as follows: two projecting wires were fastened to a wheel which turned at a constant speed. One of these wires, at each revolution, closed an electric current for a very brief time, and at regular intervals of time repeatedly effected the irritation of one end of the nerve. The second wire, on the other hand, for a very brief time connected the other end of the nerve with a multiplier. When irritation and connection with the multiplier occurred simultaneously, no trace of negative variation was observable; for, before the latter could pass from the irritated point to the other end of the nerve, the connection of the latter with the multiplier was again interrupted. By altering the position of the wires it was, however, possible to cause the connection of the nerve with the multiplier to occur somewhat later than the irritation. When this difference in time reached a certain amount, negative variation intervened. From the amount of this time, together with the length of the passage between the point irritated and that at which the current is diverted, it is evidently possible to calculate the rate of propagation of the negative variation within the nerve. Bernstein in this way determined the rate at 25 m. per second. This value corresponds as nearly with that found for the propagation of the excitement in the nerves (24.8 m.; see ch. vii. § 3) as



can be expected in experiments of this nature; and it may be unconditionally inferred from this correspondence that negative variation and excitement in the nerves are two intimately connected and inseparable processes, or rather two aspects of the same process observed by different means.<sup>1</sup>

5. The negative variation of the nerve current is not the only electric change known to occur in nerves. Under the name 'Electrotonus' we have already (ch. viii. § 1, p. 125) mentioned certain changes in the excitability which occur in the nerve fibre as soon as an

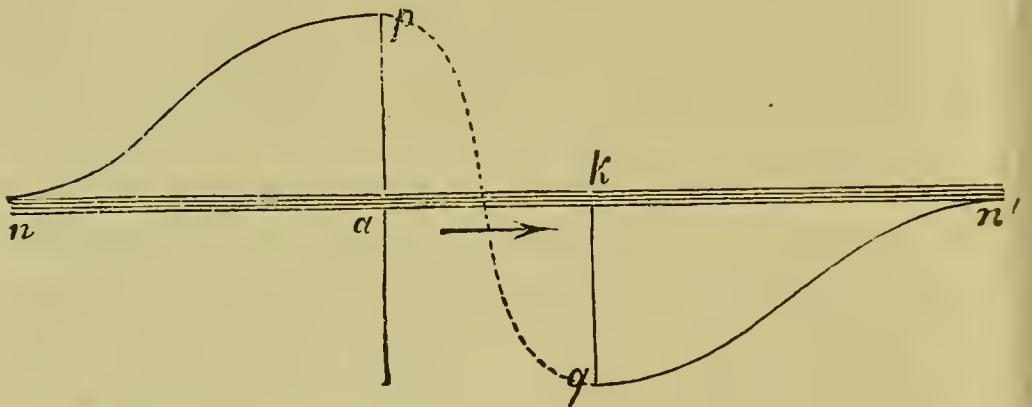

FIG. 60. THE CHANGES IN TENSION DURING ELECTROTONUS.

electric current is transmitted through a part of it. These changes in the excitability correspond with changes in the electric condition of nerves, which we called electrotonic. In fig. 60,  $nn'$  represents a nerve,  $a$  and  $k$  two wires applied to the nerve through which an electric current is transmitted from  $a$  toward  $k$ ;  $a$  is therefore the anode,  $k$  the kathode of the current employed for the generation of electrotonus. As soon as this current is closed, *all the points of the nerve on the side of the anode (from  $n$  to  $a$ ) became more positive, all on the side of the kathode (from  $k$  to  $n$ ) more*

<sup>1</sup> See Notes and Additions, No. 12.

*negative than they were.* These changes are not, however, the same in degree at all points; the change is greatest in the immediate neighbourhood of the electrode, and decreases proportionately with the distance from this. If the degree of positive increase from  $a$  to  $n$  is indicated by lines, the height of which expresses the increase, and if the tops of these lines are connected, the result is the curve  $n p$ , the form of which shows the changes in tension occurring at each point. The changes on the kathode side may be represented in the same way, but that in this case, in order to show that the tension on that side becomes more negative, the lines may be drawn downward from the nerve. The curved line  $q n'$ , is the result. The two portions of the curve  $n p$  and  $q n'$  then show the condition of the extrapolar parts of the nerve. Nothing is really known of the condition of the intrapolar portion of the nerve, for, for external technical reasons, it is impossible to examine this.<sup>1</sup> We can only suppose that changes in tension such as those indicated by the dotted curve  $p q$  occur there.

If the curve in fig. 60 is compared with the diagram of the changes in excitability during electrotonus (as given in fig. 31, page 130), the analogy between the two phenomena is very striking. The two really represent but different aspects of the same process—of the changes, that is, which are induced in the nerve by a constant electric current. Comparison of the two curves shows, however, that when the tension becomes more positive the excitability is decreased, and that when the tension becomes more negative the excitability is increased. The change

<sup>1</sup> See Notes and Additions, No. 13.

in tension and the change in excitability both probably depend on molecular changes within the nerve, as to the nature of which we are not yet in a position to say anything further, but the simultaneous appearance of which, under the influence of externally applied electric currents, is nevertheless very interesting and will perhaps in future afford a key to the nervous processes which occur during excitement.

In examining the changes in tension which take place during electrotonus, the differences in tension already existing at the various points must of course be taken into consideration. If the diverting arch is applied to two symmetrical points of the nerve, they are homogeneous. If it is applied to any other points, the existing differences in tension can be cancelled by the method of compensation above described (chap. x. § 4). The differences in tension due to electrotonus are then seen unmixed. In all other cases these differences express themselves in the form of an increase or decrease in the strength of the nerve-current which happens to be present. Yet the law of the changes in tension is the same in all cases.

6. As we found certain points of resemblance between nerves and glands, so the nerves of the tissue of the electric organs, in which in the cases of the fishes already mentioned such powerful electric action takes place, may be classed with these. Without entering deeply into the researches, as yet very incomplete, which have been made into the structure of these electric organs, we may yet accept as already proved that the so-called *electric plate*—a delicate membranous structure, very many of which, arranged side by side and under one another in regular order, constitute



the whole organ—is to be regarded as the basis of the organ. A nerve-fibre passes to each electric plate; and under the influence of irritation, whether this is due to the will of the animal or to artificial irritation of the nerve, one side of this plate always becomes more positive, the other more negative. As this occurs in the same way in all the plates, the electric tensions combine, as in a voltaic battery, and this explains the very powerful action of such organs as compared with that exercised by muscles, glands and nerves.

There is, indeed, a great difference between the last-mentioned tissues and the electric tissues of electric fish. Muscles, nerves and glands when quiescent generate electric forces, which undergo a change during activity. Electric tissue, on the other hand, is entirely inoperative when quiescent, and becomes electrically active only when it is in an active condition. Though unable to explain this difference, we must remark that it affords no ground for the inference that the actions of these tissues are fundamentally different. Whether a tissue exercises externally apparent electric action, depends on the arrangement of its active elements. But the changes which occur during their activity in muscles, glands and nerves, and also in electric tissue, are evidently so similar that they must be regarded as related. An attempt will be made in the next chapter to obtain a common explanation of all these phenomena.

7. It has already been stated that electric phenomena have been observed in plants also, though we found no sufficient reason to attribute any great physiological importance to these. It therefore created much surprise when the physiologist Burdon-Sanderson a few

years ago stated as the result of his observations, that in the leaves of Venus' Flytrap (*Dionæa muscipula*), regular electric currents occur, which, during the movement of these leaves, exhibit negative variation exactly as do nerve-currents. He was induced to make his observations by Charles Darwin, who, in the course of his study of insectivorous plants, attempted to show an analogy between the leaf-movements of the *Dionæa* and the muscular movements of animals. Darwin's observations have since been published in detail.<sup>1</sup> They show the interesting fact that in various plants glandular organs occur which secrete juices capable of digesting albuminous bodies. The plant above mentioned, *Dionæa muscipula*, is provided with these glands; and in addition to this it is irritable, as is the *Mimosa pudica* described in the first chapter. When an insect touches the leaf, the halves of the leaf close on each other, and the imprisoned insect is digested and absorbed by the secreted juice. In judging of the nature of these leaf-movements, it is necessary to decide whether they are really analogous to muscle-movements, and whether the identity extends even to the electric phenomena, as Burdon-Sanderson would have us believe. Recent researches by Professor Munk of Berlin have not confirmed this. The movements of the leaf of the *Dionæa* must be regarded as entirely similar to those of the *Mimosa pudica*. These movements are dependent, not on contractions, as are those of muscle, but on curvatures which occur in the leaf in consequence of an alteration in the supply of moisture in the different cell-strata. The leaf does indeed exercise electric action, though not in the simple

<sup>1</sup> *On Insectivorous Plants*. London, 1875.

way claimed by Burdon-Sanderson. Changes in the electric action also occur during the curvature, but these changes do not correspond with negative variation in the nerve-current; they are probably connected with the circulation of the sap within the leaf. From my own study of *Mimosa pudica* I had already adopted similar views. In this plant I was unable to detect regular electric action during quiescence; but on the falling of the leaf-stalk, I observed electric currents which might be explained as the result of the circulation of the sap. We must, therefore, be content to accept the fact that electric phenomena in plants are not to be classed with those observed in muscles, glands, nerves, and in the electric organs of certain fishes.



## CHAPTER XIV.

1. General summary; 2. Fundamental explanatory principles; 3. Comparison of muscle-prism and magnet; 4. Explanation of the tension in muscle-prisms and muscle-rhombi; 5. Explanation of negative variation and parelectronomy; 6. Application to nerves; 7. Application to electric organs and glands.

1. Summing up the most important facts given in the foregoing chapters, we may make the following statements:—

(1) *Every muscle, and every part of a muscle, when quiescent, is positive on its longitudinal section; negative on its cross-section. In a regular muscle-prism, the positive tension decreases regularly from the centre of the longitudinal section toward the ends; and the negative tension does the same in the cross-sections. In a muscle-rhombus the distribution of the tension is somewhat different, for in it the greatest positive tension is removed toward the obtuse angle of the longitudinal section, the greatest negative tension toward the acute angle of the cross-section.*

(2) *During the activity of the muscle the differences in tension decrease.*

(3) *Entire muscles often exhibit but slight differences in tension, or even none at all; but we must nevertheless assume the existence of electric opposition in them.*

(4) *Nerves are positive on the longitudinal section,*

*negative on the cross-section. The greatest positive tension is in the centre of the longitudinal section. During activity the differences in tension decrease.*

(5) *The electric plate of electric fish is, when quiescent, electrically inactive; influenced by the nerves, the one side becomes electrically positive, the other negative.*

(6) *In the glands the base is positive, the opening or inner surface negative; during activity the differences in tension decrease.*

These propositions state only the most important of the conditions which have been shown by experiment. On the outer surfaces of the tissues examined we found differences in electric tension; and we found reason to believe that the causes of these differences in tension, which occur with great regularity, must be situated within the tissues themselves. We now have to discover these causes, and this is not so easy to do as it perhaps appears at first sight. Difficult as it may be to calculate the tensions which must prevail at each point on the outer surface of a given body, within which an electromotive force is situated, yet the difficulties in this case may be overcome by skill. It is different, however, when the problem is reversed, when, the distribution of the tension having been experimentally found, it is required to discover the seat of the electromotive force. The difficulty in this case consists in the fact that the task is undefined, and that many very various solutions may be found. Moreover the task is rendered yet more difficult by the fact that we do not know whether one or many electromotive forces are present, situated in different parts of the body.

2. Let us suppose, for example, that in the body described in Chapter X. § 2, the distribution of the tension which prevails on the surface as the result of the electromotive forces then assumed, has been proved. Let us now imagine that this particular electromotive force is removed, and is replaced by another, situated at any other point in the body. Accordingly, the body will be occupied by current-curves of different form, corresponding with different iso-electric curves. Consequently, the distribution of tension on the surface is also quite different. A third electromotive force situated at any other point would again involve an entirely different distribution of the tension, and so on. Helmholtz has shown that when many such electric forces are present at one time in a body, the tension which actually prevails at each point of the surface is equal to the sum of all the tensions which would be generated at this point by each of the electromotive forces by itself. If, therefore, a certain distribution of tension has been experimentally found, it is possible to conceive many combinations of electromotive forces which might afford such a distribution of tension.

The rules of scientific logic afford a standard by which to choose to which of all these possible combinations the preference shall be given. The theory selected must, in the first place, be able to explain, not only one, but all the circumstances experimentally found. If new facts are discovered by new experiments, then it must be able to explain these also, or it must be relinquished in favour of a better theory. Secondly, if several theories seem equally to satisfy the required conditions, then preference must be given to the simplest rather than to the more complex theories.



But in all cases it must be borne in mind that these are *only theories*, the value of which consists in the very fact that they afford a common point from which all the known facts may be regarded, and that they must in no case contradict the value of scientifically established facts. We require such hypotheses, partly because they point the way to further research, and thus greatly aid the advance of science; and partly because the human understanding finds no satisfaction in the simple collection of separate facts, but rather strives, wherever it has discovered a series of such facts, to bring these, if only provisionally, into reasonable connection, and to gain a common point of view from which to regard them.

3. Turning now to our task provided with these preconceptions, we will at first confine our attention to muscle. A regular muscle-prism exhibits a definite distribution of tensions. But every smaller prism which may be cut from the larger exhibits the same distribution of tensions. No limits to this are as yet known, for even the smallest piece of a single muscle-fibre susceptible of examination is conditioned in this respect just as a large bundle of long fibres. Two possible explanations may be given of this. It may be assumed that the electric tensions are due merely to the arrangement of the muscle-prism, or such an arrangement of electromotive forces already present in the muscle may be conceived as explains all the phenomena found to occur in the muscle. ·Mateucci and others tried the first of these ways. But when du Bois-Reymond undertook the study of this subject, and, with a degree of patience and perseverance unequalled in the history of science, discovered very many

facts, for but a few of which we have been able to find place in the foregoing chapters, he was dissatisfied with this way, and, therefore, tried the second. And thus he was enabled to form an hypothesis which afforded an explanation of all the previously-known facts, of all those which have come to light since the hypothesis was first formed, and even of some which were first indicated by the hypothesis itself and were then confirmed by experiment. It is true that attempts on the other side have since been again made to restore credit to the older hypothesis, but the attempts have been in vain. We shall, therefore, fully accept the hypothesis constructed by du Bois-Reymond as being alone capable of including and combining all electrophysiological facts.



FIG. 61. THEORY OF MAGNETISM.

The phenomenon, that when a muscle-prism is cut into two halves, each part exhibits an arrangement of the electric tensions exactly analogous to that which before prevailed in the entire prism, recalls a corresponding phenomenon observed in the magnetic rod. It is a well-known fact that every magnetic rod has two poles, a north pole and a south pole. The magnetic tension is greatest at these two poles, and decreases towards the centre; and at the actual centre it = 0. If the magnet is then cut through in the centre, each half becomes a complete magnet, with a north and a

south pole, and exhibits a regular decrease of the magnetic tensions from the poles to the centre. However often the magnet is subdivided, each fragment is always a complete magnet with two poles, and a regularly decreasing tension. To explain this, it is assumed that the whole magnet consists entirely of small particles (molecules), each of which is a small magnet with a



FIG. 62. DIAGRAM OF A PIECE OF MUSCLE-FIBRE.

north and a south pole. These small molecular magnets being all arranged in the same order, somewhat as is shown in figure 61, they act in combination in the whole magnet; but each separate part also acts in the same way.

The muscle may be similarly conceived. A striated muscle consists of fibres, all of which in the case of a regular muscle-prism run parallel to each other, and are of equal length. Each fibre must be regarded, according to that which was said in Chapter I. § 2, as



composed of regularly arranged particles, each of which consists of a small portion of the simply refracting elementary substance, in which is embedded a group of the double-refracting disdiaclasses. Such a particle may be called a *muscle-element*. The muscle-fibre would accordingly consist of regularly arranged muscle-elements, the sequence of which, in the longitudinal direction, forms the fibrillæ of which mention has been made; in the lateral direction forms the discs into which the muscle-fibre may separate under certain circumstances. A diagram of a piece of muscle-fibre would, therefore, present an appearance somewhat as in fig. 62, in which each of the small rectangular figures represents a muscle-element. Each such muscle-element is, therefore, in all essential points an entire muscle, for the fibre is but an accumulation of such muscle-elements, each exactly like the other; and the whole muscle is but a bundle of homogeneous muscle-fibres. In each muscle-element we must, therefore, recognise the presence of all the qualities which belong to the whole muscle. It possesses the capacity of becoming shorter, and at the same time thicker; and finally—and this is the gist of the question here under discussion—it has the same electric characters as are observable in the entire muscle.

4. We therefore assume that every muscle-element is the seat of an electromotive force, in virtue of which it is positive on the longitudinal section, negative on the cross-section. If a single muscle-element of this sort were surrounded by a conducting substance, systems of current-curves from the side of the longitudinal section to that of the cross-section would be present within it. If many such muscle-elements are arranged

side by side and one behind the other in the regular arrangement which we have assumed, then the whole must, as has been shown by calculation, be positive throughout its longitudinal section, negative throughout its cross-sections. Now, supposing that this whole aggregation of muscle-elements is surrounded by a thin layer of a conducting substance, then currents such as are represented in fig. 63 must be present within it. These current-curves then accurately correspond with that distribution of the tensions which was experimentally shown. The greatest positive tension

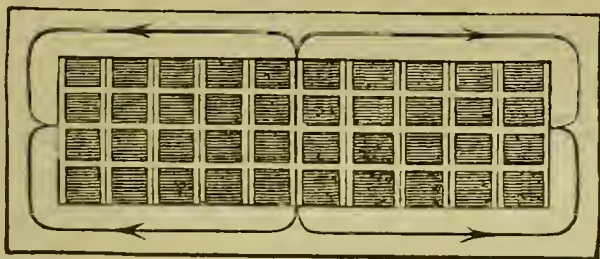

FIG. 63. DIAGRAM OF THE ELECTRIC ACTION IN AN AGGREGATION OF MUSCLE-ELEMENTS.

must prevail in the centre of the longitudinal section; the greatest negative tension in the centre of the cross section; and both must decrease in a regular way toward the edges.

We now take a bundle of muscle-fibres, the ends of which are formed by two artificial straight cross-sections, in other words, a regular muscle-prism. The separate muscle-fibres, which constitute the bundle, are surrounded by sarcolemma, held together and enveloped by connective tissue. Moreover, the outermost strata must obviously become subject sooner than the inner to the unfavourable influences of mortification, which, as we have seen, finally lead to the entire loss of electric qualities; these outermost strata there-

fore become quite inoperative, or less operative than the inner. This injurious influence must be yet more strongly developed on the cross-section, where a layer of crushed, that is, dead muscle-substance, overlies the parts which yet remain operative. Owing to all these circumstances, a coating of inoperative but conducting substance envelopes the operative muscle-elements, and the distribution of the tensions on the regular muscle-prism is fully explained. And when such a muscle-prism is divided, the conditions always remain unaltered. Each part of a muscle-prism must act as would the whole.

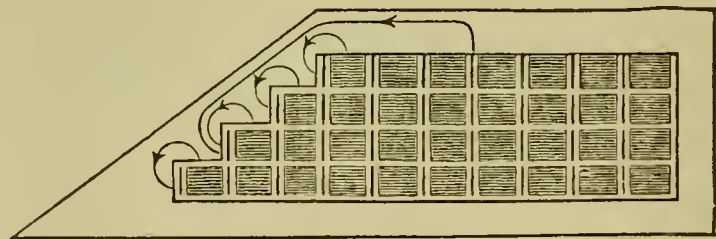

FIG. 64. DIAGRAM OF AN OBLIQUE CROSS-SECTION.

Our hypothesis is therefore quite able to explain the electric phenomena of a regular muscle-prism. We must now see how it stands in relation to the other facts which we have learned. If the artificial cross-section is made obliquely to the axis of the muscle-fibres, as in a regular or irregular muscle-rhombus, then our assumed muscle-elements, at the cross-section, will be arranged one over the other like steps, and are clothed by a layer of crushed, and therefore inoperative tissue, as is represented in fig. 64. On such a cross-section it is evident that separate currents must circulate from the positive longitudinal section to the negative cross-section of each individual muscle-element, and these combine with the current circu-



lating from the longitudinal to the cross-section of the entire prism, to make the obtuse angle more positive than negative.

5. We must next inquire how the negative variation of the muscle-current during activity can be explained in accordance with our hypothesis. We have already found reason to believe, from the phenomena of muscle-tone, that the contraction of the muscle depends on a movement of its smallest particles. Microscopic observation of muscular contraction shows that the movement takes place within each muscle-element, for the change in form may be detected in each muscle-element just as in the whole muscle-fibre. It is therefore not difficult to conceive that, in connection with these movements of the smallest particles within each muscle-element, the electromotive opposition between the longitudinal and cross-sections of that element undergo a change. It is of little importance whether we conceive the matter as though the molecules of the muscle undergo vibratory motion during contraction, or whether we give the preference to some other theory. Where facts are wanting to support or contradict certain assumptions, the imagination may have free play, and may picture any process by which changes of the kind under consideration might *possibly* be brought about. But the discreet man of science, while allowing himself this liberty, ever remembers that such free play of the imagination is of no real scientific value, either didactically, as explaining known facts, or temporarily as leading and inciting to new researches. Good hypotheses are always available in both these ways, and the scientific man uses only such. He may perhaps amuse himself in a leisure

quarter of an hour by allowing his imagination to carry the hypotheses further than the point up to which they are based on known facts; but he does not presume to urge the results on others.

Finally, we have to examine how far the hypothesis to which we have given the preference is confirmed by the phenomena observable in entire muscles. The tendonous covering on the ends of muscle-fibres may be regarded as a layer of non-active conducting substance. In so far as the same phenomena are exhibited in the uninjured muscle, as in the muscle-prism or muscle-rhombus with its artificial cross-section, nothing need be added to the previous explanations. But this is, as we have seen, though generally, yet not always the case. The natural cross-section of a muscle is generally very slightly negative, sometimes not at all, as compared with the longitudinal section; but the negative character becomes marked as soon as the natural cross-section has been destroyed in any way, either mechanically, chemically, or thermally. In explanation of this condition of the natural ends of muscle-fibres, we may assume that the arrangement of the molecules in the latter or in the terminal muscle-elements in each muscle-fibre may sometimes be different from that at all other points. If, for example, the cross-section in the terminal muscle-element were not negative, the muscle-fibre could afford no current, though such a current would arise as soon as this terminal muscle-element was removed or was transformed into a non-active conductor. E. du Bois-Reymond has lately succeeded in discovering a very probable reason for this abnormal condition of the ends of muscle-fibres; but without entering too

deeply into details we should not be able to explain this here.<sup>1</sup>

6. We will now turn our attention to nerves. The resemblance of the phenomena in the case of muscles and of nerves is so great that it is natural at once to transfer the hypotheses assumed for the former to the latter. It is true that in nerves there are not the microscopically visible particles (the so-called muscle-elements) on which we based our theory in the case of muscles, and in which we recognised the presence of electromotive forces. But from what we have already seen of the processes of excitement in the nerve, it is at least evident that in the nerve also separate particles, with independent power of movement and independent forces, must be arranged in sequence in the longitudinal direction of the nerve. If, without being able to say anything further of their nature, but because of the analogy, we call these particles *nerve-elements*, and if we assume that each of these nerve-elements is the seat of an electromotive force, in consequence of which the longitudinal section exhibits positive tension, the cross-section exhibits negative tension, then the phenomena in the quiescent nerve and the negative variation of the nerve-current during activity are explicable exactly as were the corresponding phenomena in muscles. The entirely similar behaviour of nerves and muscles when irritated is alone sufficient to show satisfactorily that the two must be very much alike in their physical structure; and the similarity of their behaviour in point of electromotive activity is such as to lend weight to our assumption of

<sup>1</sup> See Notes and Additions No. 14.



the similarity in the arrangement of their smallest particles.

But together with many points of resemblance, nerve and muscle exhibit some points of difference. The muscle during activity changes its form and is able to accomplish work; the nerve is incapable of this. The nerve, on the other hand, under the influence of continuous electric currents, exhibits those changes in excitability which we observed under the name *electrotonus*, and which, as we have seen, correspond with changes in the distribution of the tensions on the outer surface of the nerve. No corresponding phenomena have been shown in muscle. Other changes which effect these changes in tension must, therefore, occur within the nerve-element.

It is a well-known fact that all substances occupying space are regarded as composed of small particles, to which the name molecules is given. In a simple chemical body, such as hydrogen, oxygen, sulphur, iron, and so on, all these molecules consist of homogeneous atoms; in a chemically compound body, such as water, carbonic acid, and so on, each molecule is composed of several atoms of different kinds. A molecule of water, for instance, consists of an atom of oxygen and two atoms of hydrogen; a molecule of carbonic acid consists of an atom of carbon and two atoms of oxygen; a molecule of common salt consists of an atom of natron and an atom of chlorine, and so on.<sup>1</sup> A piece of salt contains a very large number of such atoms composed of chlorine and natron, but each of these

<sup>1</sup> Details of the atomic and molecular theory will be found in 'The New Chemistry.' Cooke (International Scientific Series, vol. ix.).

(in *pure* cooking salt) is like every other. But a muscle, a nerve, or any other organic tissue, is much more complex in structure. Molecules of albumen, of fats, of various salts, of water, and so on, are mingled in it. A very small piece of such a tissue must be regarded from a chemical point of view as a compound of very many different substances. To avoid confusion, the name 'muscle-element' or 'nerve-element' has been given to these particles, in which we assume the existence of all the qualities of muscle or nerve, but this name expresses nothing further than a fragment of a muscle or nerve. Even such a fragment must be regarded as of very complex structure. Very complex physical and chemical processes may take place within it; and the processes of muscle and nerve, activity, the actual nature of which is as yet quite unknown to us, are certainly connected with such chemical and physical processes. If electric forces also occur in such a nerve- or muscle-element, it is not surprising that these also undergo various changes. Of this sort must be the changes which occur during activity and during electrotonus.

In speaking, as we have occasionally done, of nerve- and muscle-molecules, we have, therefore, not used the term molecule quite in the clear and fixed sense in which the term is used in chemistry. Our conception was rather of something which, itself composed of various chemical substances, forms a unit of another order. For the sake of brevity we shall still sometimes use the expression in this sense, as, after the explanation which has now been given, we may do this without fear of being misunderstood. A muscle- or a nerve-molecule accordingly means a group of chemical mo-

lecules combined in a particular way, many of which, in combination, form a muscle-molecule or a nerve-element respectively.

We have learned to regard the negative variation of the muscle- or nerve-current as a movement of these muscle- or nerve-molecules respectively, in consequence of which the differences in tension between the longitudinal and cross-sections become less. In explanation of the electric phenomena of electrotonus, we may now assume that under the influence of continuous electric currents the nerve-molecules assume a different relative position by reason of which the distribution of the tensions on the outer surface of the nerve is changed. This changed position is retained as long as the electric current flows through the nerve, and disappears more or less rapidly after the opening of the current. At first it takes effect only within the electrodes, but it propagates itself through the extrapolar portions, becoming gradually weaker the further it is from the electrodes. In illustration of this conception, we may avail ourselves of the comparison which we have already made of the nerve-molecules with a series of magnetic needles. When the position of some of the needles in the centre of such a series is changed, owing to some external influence, those needles which lie more on the outside of the series must be turned to an extent decreasing with their distance from the centre. Or we may also refer to the conception which physicists have formed of the so-called electrolysis, the analysis of a fluid by an electric current. All these analogies can only explain the process in so far that we recognise how an electric current is capable of causing a change in the relative position of the muscle- and nerve-molecules,



at first only between the electrodes, but afterward beyond these, which change then corresponds with a change in the distribution of tension on the surface.

7. We have yet to consider how far the hypothesis under discussion explains the electric phenomena in electric fishes and in the glands. The electric shock of the torpedo must evidently be regarded as analogous to negative variation in muscle- and nerve-currents. The apparently great difference that in the latter a current present during a state of quiescence becomes weaker during activity, while in electric fishes an organ which is entirely inoperative during the state of quiescence generates a current when it becomes active, appears, when closely examined from the point of view afforded by our hypothesis, to be of no account. For, from the fact that no current in an organ can be externally shown, it by no means follows that no electromotive forces are present within the organ. A piece of soft iron is in itself entirely non-magnetic; but as this may at any time be transformed into a magnet by bringing a magnet into its neighbourhood, or by the influence of an electric current, we suppose that molecular magnets are present even in the soft iron, though these are not regularly arranged as in a regular magnet, such as that represented in fig. 61, p. 230. The action of the magnet which is brought near, or of the electric current, therefore consists solely in the fact that it arranges the irregularly placed molecular magnets within the soft iron, and thus allows their action to appear externally. If no magnetic action were known in soft iron, no one would ever have had an idea that magnetic forces were present within it. But comparison with the permanent magnet, and the possibility that thoroughly

non-magnetic iron may at any time be transformed into a magnet, makes the involved conception quite natural. It is exactly the same in the case of the electric organs of the torpedo. The fact that they, though in themselves electrically inoperative, become electrically operative under the influence of the nerves, when combined with what we know of nerves and muscle, naturally leads us to suppose that electromotive forces are present in the electric plates, but that they are so arranged as to cause no observable differences of tension on the outer surface. Under the influence of the active nerves, the particles endowed with electric forces undergo a change in their relative position, differences of tension between the two surfaces of the electric plates intervene, and, as all the electric plates in an organ act in the same way, the result is a powerful electric shock, which, in spite of its powerful effect, differs from the negative variation of the muscle- and nerve-currents only as does the powerful current of a many-celled galvanic battery from the weak current of a small apparatus.

In order to make the similarity between the electric organ on the one hand, and muscles and nerves on the other, yet more prominent, we will carry the comparison with magnetic phenomena yet further. In fig. 65,

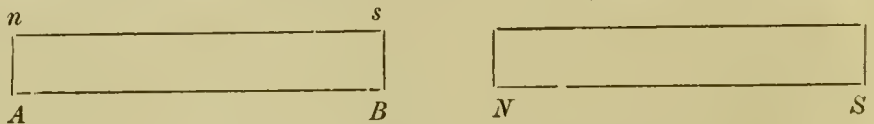

FIG. 65. MAGNETIC INDUCTION.

*A B* is a piece of soft iron, *N S* a magnet which we bring from some distance toward the iron rod *A B*. The result is to evoke magnetism in *A B*, *A* becoming a north pole, and *B* a south pole. Now, let us suppose that the non-magnetic iron rod *A B* is replaced by an entirely similar,

but magnetic rod  $N_1 S_1$  (fig. 66). At the moment at which the magnet  $NS$  is brought near, the magnetism of  $N_1 S_1$  becomes weaker, ceases entirely, or is even

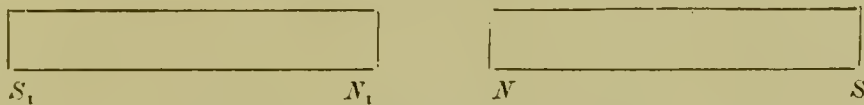

FIG. 66. MAGNETIC INDUCTION.

reversed. The same process of magnetic induction is concerned in both cases. The only difference is that in one case the induction seizes on an iron rod the molecular magnets of which are irregularly arranged, and which therefore appears non-magnetic; while in the second case the iron rod is in itself magnetic. So that in one case magnetism is evoked by induction, in the other, magnetism which was already present is weakened; but the induction is the same in both cases. In just the same way electric tensions are induced in the electric plate by the influence of the nerves, while the tensions present in the muscle are weakened; but the process in the electric plate and in the muscle is the same.

We have now only to say a few words about the glands. The phenomena in these are, so far as we can infer from the few known facts, so entirely like those in muscles, that it is only necessary to transfer the explanation which we have given in the case of the muscles to the glands. In each gland-element electric forces are present which make the base of the gland positive, the mouth-opening negative. When the gland becomes active, these differences in tension become less. There is no occasion to speculate as to how far this affects the process of secretion, as it could not further explain the process.



## CHAPTER XV.

1. Connection of nerve and muscle; 2. Isolated excitement of individual muscle-fibres; 3. Discharge-hypothesis; 4. Principle of the dispersion of forces; 5. Independent irritability of muscle-substance; 6. Curare; 7. Chemical irritants; 8. Theory of the activity of the nerves.

1. In the foregoing chapters we have examined the characters of muscles and nerves separately. The muscle is distinguished by its power of shortening and thereby accomplishing work. The nerve has not this power: it is only able to incite the muscle to activity. We must now inquire how this incitement, this transference of activity from the nerves to the muscles, occurs.

To understand the action of a machine, of any piece of mechanism, it is necessary to learn its structure and the relative positions of its separate parts. In our case, microscopic observation can alone afford the explanation. If we trace the course of the nerve within the muscle, we find that the separate fibres, which enter the muscle in a connected bundle, separate, run among the muscle-fibres, and spread throughout the muscle. It then appears that the single nerve-fibres divide, and this explains the fact that each muscle-fibre is eventually provided with a nerve-fibre—long nerve-fibres even with two—although the number of nerve-fibres which enter the muscle is generally much less than the

number of the muscle-fibres which compose the muscle. Till the nerve approaches the muscle-fibre, it retains its three characteristic marks—the neurilemma, medullary sheath, and axis-cylinder. When near the muscle-fibre, the nerve suddenly becomes thinner, loses the medullary sheath, then again thickens, the neurilemma co-

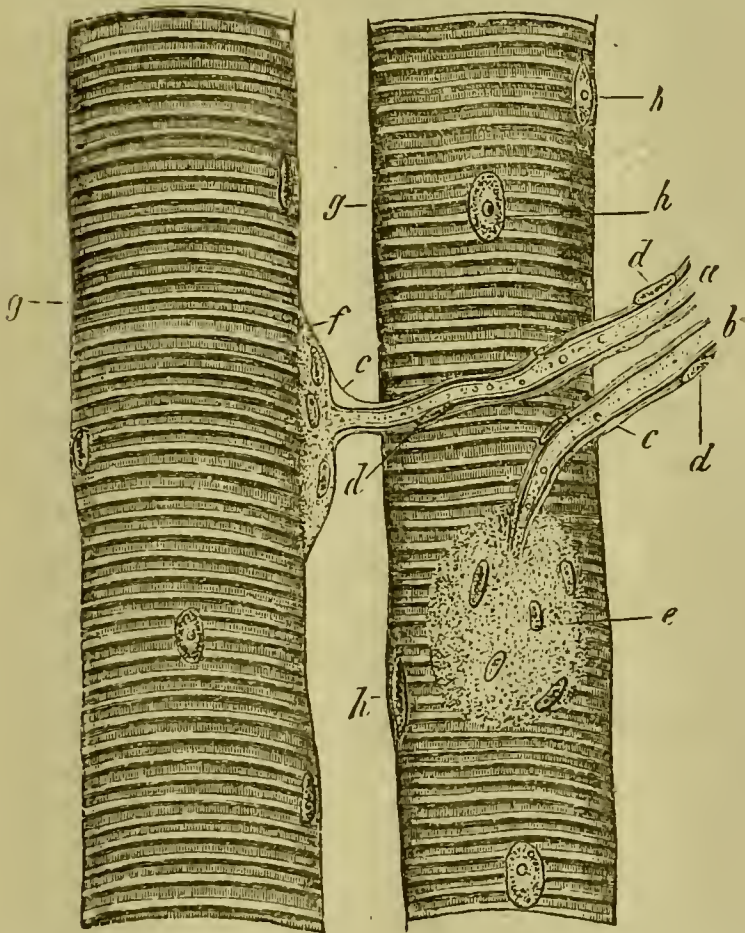

FIG. 67 TERMINATIONS OF NERVES IN THE MUSCLES OF A GUINEA-PIG.

alesces with the sarcolemma of the muscle-fibre, and the axis-cylinder passes directly into a structure which lies within the sarcolemma pouch, in immediate contact with the actual muscle-substance, and is called the *terminal nerve-plate*. Fig. 67 represents this passing of the nerve into the muscle as it occurs in mammals. In other animals the form of the terminal plate is some-

what different; but the relation between the nerve and the muscle is the same. The essential fact is the same in all cases: *the nerve passes into direct contact with the muscle-substance.* All observers are now agreed on this point. Uncertainty prevails only as to the further nature of the terminal plate. In the frog, for instance, there is no real terminal plate, but the nerve separates within the sarcolemma into a net-like series of branches, which can be traced for a short distance from the point of entrance in both directions. Professor Gerlach has recently declared that this net, as well as the terminal nerve-plate, are not really the ends of the nerves, but that the nerve penetrates throughout the muscle-substance, and that throughout the whole muscle-fibre there is an intimate union of nerve and muscle.

2. However this may be, the fact that the nerve-substance and the muscle-substance are in immediate contact must serve as the starting-point from which to attempt an explanation. When it was thought that the nerve remained on the outer surface of the muscle-fibre, there was difficulty in explaining how a pulsation of individual muscle-fibres within a muscle could be elicited by irritation of individual fibres of a nerve. For the nerve-fibres, in their course within the muscle, touch externally many muscle-fibres, over which they pass before they finally end at another muscle-fibre. In the case of flat, thin muscles, it may be shown conclusively that such a nerve-fibre may be irritated in such a way that those muscle-fibres over which it passes remain quiescent, and only those pulsate at which the nerve-fibre ends. As soon, however, as it is understood that the excitement present in the nerve-



fibre cannot penetrate through the sheaths, it is clear that the excitement can only act on the muscle-substance where the nerve-substance and the muscle-substance are really in immediate contact—that is, only within the sarcolemma pouch. The nerve-sheath is, as we already know, a real isolator as regards the process of excitement within the fibre; for an excitement within a nerve-fibre remains isolated in this, and is not transferred to any neighbouring fibre. It is quite impossible, therefore, that it can transfer itself to the muscle-substance, since it is separated from the latter not only by the nerve-sheath, but also by the sarcolemma.

But if the nerve-fibre penetrates the sarcolemma, as appears from the microscopic observations above described, and if nerve-substance and muscle-substance are in immediate contact, then the transference of the excitement present in the nerve to the muscle-substance is intelligible. The argument holds good whether we assume that the nerve, directly after its entrance within the sarcolemma, ends in a nerve-plate or a short nerve-net, or whether, as Gerlach says, it spreads further. All that is needed to make the process of transference intelligible is that the two substances should be in immediate contact, and so much is granted, whichever view is preferred. But the process, if intelligible, is yet not explained. An attempt at explanation must be based on, and have regard to, all the established facts.

3. It is natural to think of the electric characters of nerves and muscles, and to seek the explanation in these. In nerves electric tensions prevail which during the activity of the nerve undergo a sudden decrease, a so-called negative variation. Such sudden variations of electric currents are, we know, able to excite the

muscle. We may, therefore, conceive the process somewhat as follows. The excitement in the nerve, however caused, propagates itself along the nerve-fibre until it reaches the end of the latter. Connected with it is an electric process, by which a sudden electric variation is caused in the terminal apparatus of the nerve-fibre, and this excites the nerve-substance, just as a shock acting externally immediately on the muscle would excite it.

Following du Bois Reymond, the above conception may be called 'the *discharge-hypothesis* (*Entladungshypothese*). According to it, the muscle end of a nerve-fibre must be regarded as similar to an electric plate in the peculiar organs of electric fish. Indeed, in the latter, an electric discharge is effected by the influence of nerve-excitement, which is able to cause other excitable structures, such as muscles and glands, to contract. We do not attach any weight to the accidental external resemblance of the terminal nerve-plate to the electric plate. In frogs and many other animals there are no terminal plates, and yet the conditions are the same in their case also. And even if the view upheld by Gerlach is confirmed, and it is shown that nerve-substance comes into more intimate contact with muscle-substance than merely at the point at which it enters the muscle-pouch, our explanation will be unaffected. All that we claim is that an electric discharge, by which the muscle-substance is irritated, takes place in the terminal expansions of the nerves, of whatever form these expansions may be.

Against the acceptance of this view a difficulty at first seems to present itself in the fact that such an electric shock, taking place in the end of a nerve, would

excite not only the muscle-fibre in which the nerve ends, but the adjacent fibres also. For in the muscle and its envelopes no electric isolators are present, and an electric shock, occurring at any point, can and must spread throughout the whole muscle mass. But from the law of the distribution of currents in irregular conductors, the essential outlines of which are given in the twelfth chapter, it appears that the strength of the current in the immediate neighbourhood of the spot at which the discharge actually takes place may be considerable, though it decreases so rapidly with increasing distance, that it is easy to believe that it may be quite unnoticeable, even in a muscle-fibre which stands side by side with the fibre directly irritated. It is this very circumstance which lends especial weight to the fact that the nerve penetrates within the muscle-fibre, and there comes into immediate contact with the muscle-substance. Only in this way is it intelligible that a discharge occurring in the nerve can irritate the muscle. When the excitement has once arisen at any point within the muscle-substance, it can, as we have seen, spread within the muscle-fibre. It is possible that this may result without any co-operation of the nerve-substance; so that the spreading of the nerve within the muscle-substance, as claimed by Gerlach, is not required to explain the processes within the muscle.<sup>1</sup>

4. We therefore assume that the excitement arising in the nerve itself becomes an irritant, which then irritates the muscle. The forces which are generated, in consequence of this, in the muscle are, as we know, able to accomplish considerable labour, which bears no relation to the insignificant forces which act

<sup>1</sup> See Notes and Additions, No. 15.



on the nerve and which are active in the nerve itself while the latter transmits the excitement. To use a common but appropriate simile, the nerve is but the spark which causes the explosion in the powder-mine; or, to carry the simile further, the sulphur train which, being fired at one end, carries the fire to the mine, and there causes the explosion. The forces which are set free within the muscle are chemical, due to the oxidation of its substances; the irritant originating from the nerve is only the incitement in consequence of which the chemical forces inherent in the muscle come into play. Physicists call such processes the *freeing of forces*. The nerve-irritant, therefore, frees the muscle-forces, and these translate themselves into warmth and mechanical work. In every such freeing, the freeing force is generally very small when compared with the forces set free, and which may be dormant for incalculable periods; though when they are once set free, they are capable of enormous effects. A huge block of stone may for years hang in unstable equipoise on the edge of a precipice till some insignificant disturbance makes it fall, carrying destruction to all in the way of its descent. It is even supposed that the slight disturbance caused in the air by the sound of a mule-bell is sufficient to start the ball of snow which at last thunders down into the valley in the form of a mighty, all-destroying avalanche. This freeing by small forces is only possible in the case of unstable equipoise. But there is also a chemical unstable equipoise. Carbon and oxygen may lie for thousands of years side by side without combining. Closely mingled, as in gunpowder, or still more closely, as in nitro-glycerine, they are in unstable equipoise; the slightest blow suffices to cause

their combination, which by their expansion is able to accomplish such gigantic work.<sup>1</sup> In muscle, too, carbon and oxygen lie side by side in chemical unstable equipoise; and it is the irritation of the nerves which effects the solution which destroys the equilibrium. An arrangement such as that just described is called *sensitive*, because even an insignificant disturbance is sufficient to disturb the unstable equipoise and to develop force. The muscle is therefore a sensitive machine. But the nerve is in a yet higher degree sensitive, for the smallest disturbance of its equipoise gives play to the forces within it. But these forces are in themselves incapable of any great effects. They would hardly be indicable, were not this sensitive machine, which we call the nerve, connected with the machine, also sensitive, which we call muscle, in such a way that the activity of the one sets free the forces within the other.

5. A sensitive machine is not equally sensitive to all possible disturbances. Dynamite<sup>2</sup> may be placed on an anvil and hammered without exploding; or, if lighted with a cigar, it burns quietly out like a firework. But when it comes in contact with the spark of a percussion cap, it explodes, and develops its gigantic forces. A nerve is sensitive to electric shocks, and to certain mechanical, chemical, and thermic influences. It is not sensitive to many other influences. The influences to which the nerve is sensitive we have called irritants. A muscle is sensitive to electric shocks, to certain mechanical, chemical, and thermic influences;

<sup>1</sup> On these processes see Balfour Stewart 'On the Conservation of Energy' (International Scientific Series, vol. vi.); and Cooke on 'The New Chemistry' (same series, vol. ix.).

<sup>2</sup> Dynamite is a mixture of nitro-glycerine with 'kieselguhr,' an earth consisting of the shells of infusoria.

and, above all, to the influence of the active nerve. The latter may perhaps, as we have explained in the foregoing paragraphs, be referred back to electric irritation. It is thus apparent that muscle and nerve behave essentially in the same way towards irritants. But, remembering that nerves run for part of their course within the muscle, between its fibres, and even penetrate within the very muscle-fibres, the thought now suggests itself, that perhaps the muscle is in no way electrically, chemically, thermically, or mechanically irritable; perhaps, when these irritants are allowed to act on the muscle, it is only the intra-muscular nerves which are irritated, and which then in turn act on the muscle-fibres. In other words, we have to determine whether the muscle is only irritable mediately through the nerves, or whether it is also immediately irritable, independently of the nerves, by any irritants.

The question is not a new one. Albert von Haller, poet and physiologist (1708–77), asked it, and even he was not the first to do so. Haller declared himself in favour of the second of the two above-mentioned possibilities. He called this capacity of the muscles to receive independent irritation (*Irritabilität*), and the name has been retained. Haller met with much opposition from his contemporaries; and a dispute arose which has lasted to the present time. In Haller's days, of course, only the larger nerve-branchings were known. The further the nerves can be traced by means of the microscope, the harder does it evidently become to determine the question under discussion.

6. In the year 1856, the French physiologist Claude Bernard made experiments with a poison brought from Guiana, which the Indians of that region use to poison



their arrows. It is called curare, ourari, or wurali, and is a brown, condensed plant juice, which is brought over in hollowed, gourd-like fruits called calabashes. He found that animals poisoned with this curare are disabled, and that in animals thus disabled, irritation of the nerve-trunks, even with the strongest electric or other irritants, is entirely ineffective, though the muscles are yet easily irritable. This was indeed no new phenomenon. Harless, at Munich, had already observed something similar in strongly etherised animals. But soon afterwards, Koelliker, at Würzburg, and, simultaneously, Bernard himself, in extending the experiments of the latter, found something new. If ligatures are applied to the hough of a frog, and the animal is then poisoned with curare, the lower leg is not disabled. By irritation of the sciatic nerve the muscles of the lower leg may be induced to contract where the poison could not penetrate, the appropriate vessels being tightly constricted. Curare, therefore, does not disable the muscles, for these always and everywhere remain irritable; nor does it disable the nerve-trunks, for these remain irritable if the poison cannot reach the muscles. There is but one other thing possible: the poison disables something which is between the nerve-trunk and the muscle-fibre, so that the nerve-trunk can no longer act on the muscle. If that which is disabled is the end of the nerve, then the immediate irritability of the muscle-substance, without the participation of the nerves, about which there has been so much strife, is proved.

This striking phenomenon is not solitary. The action of some other poisons, such as nicotine and conine, is entirely like that of curare. These also dis-

able, not the nerve-trunks or the muscle-substance, but some part intermediate between these two. The difficulty is to prove that this part is exactly the final termination of the nerves. Assuming that these poisons disable some part which lies between the nerve-trunk and the muscle, but not the very end of the nerve, then, though all the phenomena explained above are quite intelligible, yet no answer has been gained to the question of irritability, which we are discussing.

Considering now the characters of the nerve, and of its passage into the nerve-fibre, it is easy to understand why the poison does not take effect on the nerve-trunks. The nerve-fibres receive but few blood-vessels, so that the poison in solution in the blood can only reach them slowly, and in very small quantity. Moreover, the fatty medullary-sheath probably forms a sort of protective envelope round the axis-cylinder. But where the nerve enters the muscle-fibre it loses the medullary sheath: and just at this same point a very complex net of blood-vessels is present. Probably, therefore, it is exactly the terminal nerve-plate (or the corresponding nerve-branchings in the naked amphibia) which is most exposed to the attack of the poison. So long, however, as it is impossible to prove that this is really the actual end of the nerve-fibre, a chance is left open to the opponents of the theory of irritability.

Great pains have been taken to settle this point with certainty. If a muscle poisoned with curare is compared with a similar but unpoisoned muscle, it appears that the former is less excitable; that is, that stronger irritants are needed to cause it to pulsate. The explanation of this may be that the muscle-substance is excitable, but not so much so as the intra-

muscular nerves. The following reasons may also be given for the probability of the independent irritability of muscle-substance. A nerve is, as is known, strongly excited by short, sudden variations of a current, and an unpoisoned muscle behaves in the same way; but a muscle poisoned with curare is less sensitive to current shocks of short duration than to such as take place more slowly. If we ascribe independent irritability to muscle-substance, then greater sluggishness prevails in muscle-substance than in nerve-substance, so that the irritating influences require longer time to take effect in the former. In the case of nerves it has, moreover, been shown that currents which pass at right angles to the longitudinal direction of the nerve-fibre are entirely ineffective. In muscles under the influence of curare no difference in this point can be shown. If the independent irritability of muscle-substance is denied in spite of this, it must be assumed that in these experiments the point lies in differences between the nerve-fibres and their real ends. But nerves and muscles are evidently very similar, and it might evidently be possible to assume considerable difference between nerve-fibres and nerve-ends, and that these nerve-ends differ from the muscle-substance in nothing but that the power of being irritated is ascribed to the former, while it is denied to the latter. It appears then, that the whole dispute resolves itself into an empty word-strife as to whether this thing which lies between the nerve-fibres and the muscle-substance is to be reckoned as part of the nerve or as part of the muscle.

7. The much-discussed question of the independent irritability of muscle-substance is, as appears from what has now been said, due principally to the fact that the



same irritants which act on the nerve are also able to act on a muscle, and even on a muscle poisoned with curare. We have, however, found slight differences, and, if it were possible to show the existence of greater differences, especially if irritants were found which act on muscle-substance but not on nerve-substance, a new point of departure would be gained for this theory of independent irritability. Chemical irritants are beyond all others capable of variation. From the endless number of chemical bodies we may choose such as irritate the nerve or muscle in general, and we may try each of these in every degree of concentration. If differences between nerve-substance and muscle-substance really exist, it is probable that we shall find them by these means. Starting from these premisses, Kühne experimented on the condition of nerves and muscles; and he was so far successful that he discovered some differences.

In studying the character of nerves and muscles relatively to chemical irritants, it is best to make a cross-section, and to apply the substance which is to be tested to this section. It is best to apply the test to a thin parallel-fibred muscle, usually to the *musculus sartorius* of the upper leg. It is suspended upside down from a vice, which holds fast its lower pointed tendon; and its upper end, which now hangs downward, is then cut. The liquid which is to be tested is then brought in contact with the cross-section thus made, and care is taken to observe whether a pulsation takes place or not. The short, used portion having then been cut off, the experiment can be repeated, and so on till the whole length of the muscle has been used. The nerve is treated similarly; the sciatic nerve

is, as in all experiments by irritation, used for the purpose, either in connection with the whole lower leg, or only with the calf-muscle. If the effect of volatile bodies—vapours or gases—is to be tested, the muscle must be shut off from the nerve in an adequate manner.

The muscle is extraordinarily sensitive to certain substances. One part of hydrochloric acid in from one thousand to two thousand parts of water affords strong pulsations. The smallest trace of ammonia is enough to cause strong contraction. The observer must therefore abstain from smoking whilst experimenting, for the slight amount of ammonia in tobacco-smoke is sufficient to elicit continued pulsations. The nerve, on the contrary, is much less sensitive towards hydrochloric acid, and is not at all sensitive towards ammonia. If the nerve is immersed in the strongest solution of ammonia it very soon dies, but is not at all irritated. These are the most marked differences. But it must also be mentioned that glycerine and lactic acid in concentration exercise an irritating effect on the nerve, but not on the muscle; and that when many other substances (alkalies, salts) are applied, small differences are exhibited, in that sometimes the nerves, sometimes the muscles, contract in response to a somewhat thinner concentration.

It thus appears that the differences are extremely slight. Kühne, however, attaches weight to these, and interprets them as favourable to the theory of the independent irritability of muscle-substance. He supports this conclusion by the following observations. In the case of specific muscle-irritants (ammonia, greatly diluted hydrochloric acid) the result is the same whether the experiment is tried on an ordinary muscle, or on

one poisoned with curare. Nor does it make any difference whether a strong ascending current is passed through the nerve of a *sartorius* thus conditioned, thus inducing strong anelectrotonus in the intra-muscular nerve-branchings, so as to disable it. He sees in this a proof that the nerves which spread through the muscle do not share in this form of irritation. He has, moreover, discovered that the nerves are not equally distributed throughout the *sartorius*. They enter at a point somewhat below the middle of the muscle, and distribute themselves upward and downward between the muscle-fibres; but they cannot be traced to the ends of the muscle, and there are at these ends regions of from 2 to 3 m. in length, in which at least the larger muscle-fibres are wanting. (Whether the nerve-net which, according to Gerlach, lies within the sarcolemma, extends to these regions, is another question with which we have nothing here to do.) The specific muscle-irritants affect these regions exactly as they do the rest of the muscle; while the specific nerve-irritants (concentrated lactic acid and glycerine) are never able to affect these ends, though they elicit single pulsations in the parts containing nerves. These nerve-containing parts are also more electrically excitable than are the ends; by curare and by anelectrotonus their excitability is decreased, though that of the nerveless ends remains unaltered.

Many objections have been brought forward against these conclusions. For my part, in the very insignificance of the differences between nerve and muscle in this point also, I am inclined to see new reason to believe that these two organs, so similar in all points (as yet we know only two important differences, which



are, that the muscle is contractile, which the nerve is not, and that electrotonus, which intervenes in nerve, cannot be shown in muscle), may also be entirely similar in the matter of irritability, and that those who dispute this quality are forced to assume the existence of a substance intermediate between that of the nerve and of the muscle, and which differs almost more from the nerve than from the muscle.

8. Summing up, it appears that the independent irritability of muscle-substance has not been proved; nor has it been disproved. To understand how the nerve acts on the muscle one must assume that the latter is irritated by the former, and therefore there is no sufficient reason, remembering the similarity in all other points between nerve and muscle, to dispute that it may also be irritated by other irritants (electric, chemical, mechanical, or thermic). In the theory above explained as to the nature of the influence on the muscle, we have assumed that this irritation takes place electrically. We have therefore tacitly presupposed that the muscle is electrically excitable. Except on this assumption, all that can be said is that the molecular process originating in the nerve is transferred to the muscle: which explains nothing, but rather renounces all explanation. Our hypothesis, on the other hand, has the undeniable advantage that it is based on the well-known process of the negative variation of the nerve during its activity. That the negative variation, when it has once originated in the nerve, propagates itself to the nerve-ends, can only be regarded as natural, and, provided that it is of sufficient strength, it can then act as an irritant on the muscle.

We have already seen that the nerve must be

regarded as composed of many particles arranged one behind the other, each of which is retained in a definite position by its own forces and by the influence of the neighbouring particles. Whatever acts as an irritant on the nerves must displace these particles from this position, and must cause a disturbance, which then propagates itself, owing to the fact that a change in the position of one particle causes a disturbance in the equilibrium of the adjacent particles, in consequence of which the latter are set in motion. Negative variation must be regarded as a result of this movement of the nerve-particles, in that the electrically acting parts are arranged in different order by the movement, and therefore must exercise a different external influence. But just as this change in the position of the nerve-particles is able to set the needle of a multiplier, if it is properly connected with the nerve, in motion, so the electric process originating in the nerve must act on the muscle, if the latter is sensitive to electric variations. This was the assumption from which we started, and which, after the above explanations, will be regarded as thoroughly trustworthy. To enter further into the details of the activity of nerves and muscles, and to substitute more definite conceptions for such as are at present often indefinite, is impossible in the present state of knowledge.

## CHAPTER XVI

1. Various kinds of nerves; 2. Absence of indicable differences in the fibres; 3. Characters of nerve-cells; 4. Various kinds of nerve-cells; 5. Voluntary and automatic motion; 6. Reflex motion and co-relative sensation; 7. Sensation and consciousness; 8. Retardation; 9. Specific energies of nerve-cells; 10. Conclusion.

1. At present we have paid attention only to such nerve-cells as are in connection with muscles, and by the activity of which the appropriate muscles are rendered active. We have referred only incidentally to other kinds of nerves. The difficulty due to the circumstance that a suitable reagent is necessary for the study of such nerve-activity as does not express itself in any visible change in the nerve, compelled us to confine our studies in the first place to muscle-nerves or *motor nerves*, in which the muscle itself acts as the required reagent. We now have to discover how far the experiences which we have gained of motor-nerves, and the views which we have based on these experiences, are applicable to other nerves.

Besides the real motor nerves, we may distinguish those which act on the smooth muscle-fibres of the blood-vessels, through these effecting a decrease in the diameter of the smaller vessels, and thus regulating the circulation of the blood. These are called *vaso-motor nerves*. They are, however, in no way different from



other motor nerves. But a difference is observable even in the case of the *secretory nerves* or gland-nerves, of which we have already had occasion to make mention. When these nerves are irritated the appropriate nerves begin to secrete. The connection of these nerves with the glands must from a physiological point of view be entirely similar to that of the motor nerves with the muscles. When the latter are irritated the muscles connected with them at once pass into a state of activity. Just in the same way the gland-nerves, when they are irritated, cause the glands connected with them to pass into a state of activity. That this activity is quite different from that of the muscles, is obviously due to the entirely different structure of the glands and the muscles. A gland, unlike a muscle, cannot contract; when it becomes active, it secretes a liquid, this being its activity. There is therefore no reason to assume any difference in any of these nerves, the difference in the terminal apparatus, in which the nerves end, being sufficient fully to explain the difference in the phenomena.

But there are other nerves the action of which is much harder to understand. Among these are the *sensory nerves*. When these are irritated, they effect sensations of different kinds, some being of light, others of sound, and so on. Moreover these nerves are capable of receiving irritation in a peculiar way, some by waves of light, others by sound vibrations, and others again by heat-rays; but in all cases, only when these influences act on the ends of the respective nerves. It is not self-evident that these nerves are homogeneous in themselves or with the previously mentioned kinds. Finally, it is yet harder to understand the action of

another, and the last class of nerves, which are called *retardatory nerves* (Hemmungs-nerven). It is common knowledge that the heart beats ceaselessly during life. Now, if a certain nerve which enters the heart is irritated the heart ceases to beat, recommencing when the irritation of the nerve is discontinued. This remarkable fact was discovered by Edward Weber, who spoke of the phenomenon as retardation. It is curious that a nerve can by its activity still a muscle which is in motion.

2. Before we endeavour to determine this and the other points raised, we must note whether any differences can be shown in these various nerves, which act in such entirely different ways. In the previous chapters we have observed so many peculiarities in nerves, and among these, qualities which can be examined without the intervention of the muscle, that it seems not altogether unjustifiable to hope that we may be able to observe differences also in nerves if any such occur. But if this is impossible, if all nerve-fibres, though examined in every possible way, seem to be quite homogeneous, then we shall be justified in considering them really homogeneous, and must look for an explanation of the variety in their actions in other circumstances.

It may at once be said that it is quite impossible to show differences in the different kinds of nerves. Microscopic observation shows no differences; for the difference, to which allusion has already been made, between medullary and medulla-less fibres does not affect the point in question. We are obliged to infer that the medullary sheath is of entirely subordinate significance in the activity of the nerve. At any rate,

the presence or absence of this medullary sheath does not correspond with differences in the physiological actions of nerves. Nor are the small differences in diameter of the separate nerve-fibres of greater importance. Nor do experimental tests bring any differences to light. The bearing of nerves to irritants does not vary: the electromotive effects are the same in all. In all these points we need simply refer to the previous chapter, for the explanations there given are equally true of all kinds of nerve-fibres.

If, therefore, all kinds of nerve-fibres are alike, we can only explain the difference in their action as due to their connection with terminal organs of various form. We have already made use of this principle in explanation of the difference between motor and secretory nerves, and we must now endeavour to extend it to all other nerves.

3. While the motor and secretory nerves have their terminal organs in the periphery of the body, the sensitive or sensory nerves act on apparatus which are situated in the central organs of the nervous system. An irritant which affects a motor nerve, to become apparent, must propagate itself toward the periphery, till it reaches the muscle situated there; an irritant, on the other hand, which affects a sensory nerve, must be propagated toward the centre before it sets free any action. Nerves of the former kind are therefore called *centrifugal*, those of the latter *centripetal*. We have, however, already found that this does not depend on a difference in the nerve itself, but that each nerve-fibre, when it is affected at any point in its course, transmits the excitement in both directions; and we therefore presumed that the fact that action takes place only at one end



must be due to the nature of the attachment of the fibres to the terminal apparatus. (*Cf.* chap. xiii. § 3, p. 217.)

After we had carefully examined the peripheric terminal apparatus of the motor nerves, that is to say, the muscles, we were in a position to study the processes in motor fibre. In order now to understand the action of sensory fibres, it will be therefore necessary first to obtain further knowledge of the central nervous organs.

The central organs of the nervous system, in addition to nerve-fibres, include, as we have seen (chap. vii. § 1, p. 105 *et seq.*), also cellular structures, called *ganglion-cells*, *nerve-cells*, or *ganglion-balls*. They are not always globular, but are generally irregular in form. Beside the forms represented in fig. 27 (p. 106), which occur scattered here and there in the course of the peripheric nerves, forms such as those represented in fig. 68 occur much more abundantly in the central organs. They generally have many processes (four, six and even up to twenty), which branch and unite together like network. Many cells exhibit one process, differing from the others, which passes into a nerve-fibre (*nerve-process*: cf. fig. 68, 1a and 3c). These nerve-processes pass out from the central organ and form the peripheric nerves. Within the central organ the processes of the ganglion-cells form a very involved network of fibres; between these there are, however, other fibres which completely resemble the peripheric nerve-fibres. There is no reason for ascribing to these fibres of the central organ qualities other than those of the peripheric fibres. When in the central organ phenomena are observed which never occur in the peri-

pheric nerve-fibres, it is natural to refer these to the presence of the ganglion-cells.

As a matter of fact, all organs which contain nerve-cells, the central organs as well as the peripheric



FIG. 68. GANGLION-CELLS FROM THE HUMAN BRAIN.

1. A ganglion-cell, of which one process, *a*, becomes the axis-cylinder of a nerve-fibre, *b*.
2. Two cells, *a* and *b*, interconnected.
3. Diagrammatic representation of three connected cells, each of which passes into a nerve-fibre, *c*.
4. Ganglion-cell partly filled with black pigment.

organs, in which they are present, though not so abundantly, exhibit certain peculiarities, which we must regard as caused by the nerve-cells. And as we are in no case able to examine the nerve-cell by itself, but must always examine it in connection with, and mingled with the nerve-fibres, we can but carefully determine the dif-

ference in the behaviour of these organs from that of ordinary nerve-fibres, and then regard all not appertaining to the nerve-fibres as peculiar to the nerve-cells.

We know that the nerve-cells are irritable, that they transmit the excitement which arises in them, and transfer it at the terminal organ. The excitement can never occur of itself in a nerve-fibre, but it always results from an irritant acting externally, and can never pass from one nerve-fibre to another, but always remains isolated in the excited fibre.

But where nerve-cells occur, the case is different. As long as a nerve-fibre passes uninjured from the brain and spinal-marrow, or from one of the accumulations of nerve-cells situated in the periphery, to a muscle, excitement arises without externally visible cause, and this acts through the nerve on the muscle, sometimes at regular intervals independently of the will, sometimes from time to time at the instigation of the will. Again, where nerve-cells occur, we find that excitements which are transmitted to the central organ by a nerve-fibre may there be imparted to other nerve-fibres. Thirdly, we find that excitements which are transmitted to the central organ by nerve-fibres there elicit a peculiar process, which is called sensation and consciousness. Fourthly and finally, the remarkable phenomenon, mentioned above, of retardation, only occurs where nerve-cells are present. The four following qualities, which are entirely absent in nerve-fibres, must therefore be attributed to nerve-cells:—

(1) *Excitement may arise in them independently, i.e. without any visible external irritant.*

(2) *They are able to transfer the excitement from one fibre to another.*



(3) *They can receive an excitement transmitted to them and transmute it into conscious sensation.*

(4) *They are able to cause the suppression (retardation) of an existing excitement.*

4. From the above it must not be supposed that all ganglion-cells possess all these qualities. On the contrary, it is to be supposed that each nerve-cell performs but one of these functions, and even that there are more minute differences in them, so that, for instance, the nerve-cells which accomplish sensation are of various kinds, each of which accomplishes but one distinct kind of sensation. This is no mere hypothesis, for there are established facts which confirm the view. Conscious sensations occur only in the brain, and the various parts of the brain may be separately removed or disabled, in which case individual forms of sensation fail, while others remain undisturbed. If the whole brain is removed, the nerve-cells of the dorsal marrow suffice fully to accomplish the phenomena of the transference of excitement from one nerve-fibre to another. Again, there are certain regions of the brain which separately are able to give rise to independent excitement in themselves; and certain accumulations of nerve-cells which lie outside the actual central nervous organs have the same power. The forms which nerve-cells assume being very varied, it often happens that the cells of certain regions, where only certain capabilities can be shown, are alike in form, and differ in this respect from the cells of other regions, where the capabilities are different. As yet, however, it has not been found possible to distinguish differences in form sufficiently characteristic, and relations between the form and the function of nerve-cells sufficiently characteristic to

make it possible definitely to infer the function of a cell from its form. On the contrary, it is better, by experiments with animals and experiences with invalids, to determine step by step what functions belong to the cells of a given region. Considering the complex and yet very imperfectly known structure of the central nervous organs, it is not surprising that this task has by no means yet been fully accomplished. As in the present work we are not treating of the physiology of the separate parts of the nervous system, but are only concerned with the general characters of the elements which constitute the nervous system, we must not enter into details; but we must be satisfied to show what the nerve-cells in general are able to accomplish and to give due prominence to the fact that each separate nerve-cell is probably always able to accomplish only one definite thing. We will now run through these capacities and show the facts which serve as proof of these.

5. The natural rise of excitement takes place either voluntarily or involuntarily. We are always able voluntarily to contract our muscles, though not all of these, for many, especially the smooth forms, are not subject to the will, but contract only as the result of other causes. Sometimes, moreover, the want of power to contract certain muscles is to be ascribed only to want of use, as is shown by the fact that some men are able voluntarily to contract the skin of their scalps or their ear-muscles, though this is impossible to most men, or is possible only in a very restricted degree. Similarly, it is a matter of use how far the will is able to effect a limited contraction of separate muscles or parts of a muscle.

Those beginning to play the piano find it difficult to move individual fingers apart from the others, though by practice they soon learn to do this. Whenever an intended contraction of a muscle is accompanied by another unintended and simultaneous, the latter is called a *co-relative movement*. Such co-relative movements sometimes accompany illness. Stammerers, for instance, when they speak, twitch the face muscles or even those of the arm. It has also been observed that in the case of injuries, after blood has been lost from the brain, movements of the injured limbs not voluntarily possible occur involuntarily as co-relative motions. Some co-relative movements are natural in the organism; for instance, when the eye is turned inward, the pupil simultaneously decreases in size, and a contraction of the adjusting muscle occurs, by which the eye is enabled to see at a short distance. This co-relative motion has been regarded as a case of the transmission of the excitement from one nerve-fibre to another; but it seems to me that this is incorrect. For there is nothing to show that the excitement originated in one fibre and was then transferred to other fibres, and it is more simple to assume that the various fibres were excited simultaneously by the will, either because isolated excitement of these fibres separately is really impossible on account of the anatomical structure of the nerve, or because of an insufficient specialisation of the influence of the will, resulting from want of exercise—that is, it is due to unskilfulness on the part of the will.

If it is asked how the voluntary excitement of the nerve-fibres is caused in the nerve-cells, an answer is yet to be sought in physiology. Into the question



whether there is actually a purely voluntary excitement, that is, that no incitement acted externally on the brain but that the excitement originated quite spontaneously, we will not enter further here. All that is certain is that in many cases an action appears to be voluntary which, if the process is more closely analysed, is found to result from external influences. But the physiological process by which (whether externally influenced or not) excitement arises in the nerve-cells, which excitement is then transmitted through the nerve-fibre to the muscle, is as yet extremely obscure; and if it is said that it is a molecular motion of the constituent particles of the nerve-cell, this explains nothing, but merely expresses the conviction that it is not a supernatural phenomenon, but merely a physical process analogous to the process of excitement in the peripheric nerves.

Involuntary movements occur sometimes irregularly, as twitchings, spasms; sometimes regularly, as in the case of respiratory movements, the movements of the heart, the contractions of the vascular muscles, of the intestinal muscles, and so on. The latter, which occur with more or less regularity while life lasts, and are for the most part of deep significance as regards the normal condition of the vital phenomena, have naturally been especially subjected to thorough research. They are called *automatic movements*, that is, they occur independently of the co-operation of the will, and apparently without any incentive. But notwithstanding this, it is chiefly in such cases that the causes which effect the excitement of the nerves concerned have been to a certain extent established.

Automatic movements may be distinguished into

such as are *rhythmic*, in which contraction and relaxation of the muscles concerned take place in regular alternation, as in respiration and in the movements of the heart; such as are *tonic*, in which the contractions are more constantly enduring, even if the degree of contraction varies, as in the contraction of the vascular muscles, and of the rainbow membrane of the eye; and such as are *irregular*, i.e. the peristaltic movements of the intestine. Our knowledge of automatic movements is based principally on those connected with respiration; but the conceptions gained in this case may be directly applied to the other cases. It will be sufficient therefore to speak of respiratory motion only.

Respiration begins immediately after birth, and its movements continue from that time throughout life. In the higher animals (mammals and birds) they are unconditionally necessary for the preservation of life, for only by their means is sufficient oxygen conveyed to the blood to provide for all the vital processes. On the other hand, when the organ from which the excitement of the respiratory muscles proceeds is in any way insufficiently nourished or is otherwise injured in condition, respiratory action ceases and life is threatened. This organ is a limited point in the *medulla oblongata*, formed of a mass of nerve-cells, in which the excitements originate, and from which they are conveyed by the nerves to the respiratory muscles. This is called the *respiratory centre* (*Lebensknoten* of the Germans, *nœud vital* of the French), because of its importance to life. It is the spot which the matador in bull-fights must reach by a skilful blow with his knife, to bring the enraged animal to the ground; it is the spot which if crushed between the

first and second vertebræ, the result is instant death by the so-called dislocation of the neck. It has been shown that the cause which induces this ceaseless activity in the nerve-cells of the respiratory centre lies in the character of the blood. When the blood is quite saturated with oxygen, then the activity of the respiratory centre commences.<sup>1</sup> When the blood becomes freer from oxygen, the respiratory motions become stronger.

Far from being necessarily active, independently and without external incentive, the nerve-cells of the respiratory centre are also rendered active by external circumstances. But they are much more sensitive than the nerve-fibres, so that they are influenced even by slight changes in the gaseous contents of the blood which plays over them. And the other automatic nerve-cells behave exactly as do the cells of the respiratory centre. Yet small differences in sensitiveness occur among them, so that some are excited even when only the average amount of oxygen is contained in the blood, others when a point lower than this average has been reached, as happens only occasionally during life.

It would take too long to apply this theory, now

<sup>1</sup> Experimental proof of this may always be tried by anyone on himself. Attention must be given for a time to the respiratory movements, their depth and number being noted. From eight to ten inspirations and expirations are then drawn slowly one after the other. By this means much more air is introduced into the lungs than by ordinary respiration, and the blood can therefore thoroughly saturate itself with oxygen. If, after this, voluntary respiration is ceased, it will be found that twenty seconds or more elapse before a respiration again occurs, long enough that is for the consumption of the introduced oxygen. Only after this do respirations begin, at first weakly, but always increasing in strength, until the former regular respiration again prevails.



briefly explained, to each of the other processes of automatic motion. We must content ourselves with the remark that an analogous conception of the nature of the movements of the heart is probable, though no experimental proof of its correctness has yet been achieved. The cause of movements of the intestine is not quite so difficult to understand; at any rate, the main principles found in the case of the nerve-cells of the respiratory centre are valid in the case of all other automatic centres.<sup>1</sup> Mention must still be made of the fact that in the heart and intestine the nerve-cells from which the automatic action proceeds are situated within the respective organs themselves. For this reason these organs can yet exhibit movements after the nerve-centres have been destroyed, or the organs have been cut from the body.

6. The transference, by means of the nerve-cells, of an excitement from one nerve-fibre to another is most clearly shown in that which is called *reflexion*. By this term is meant the passage of an excitement, which having acted on a sensory fibre has been transmitted by it to the nerve-cells, to a centrifugal fibre, by which it is conducted back from the centre (as a ray of light is reflected from a mirror) and makes its appearance at another point. The reflection can occur either in a *motor fibre*, in which case it is called a reflex action, or in a secretory or retardatory fibre. The former case is more common and better known. As examples of such reflex actions, I may mention the closing of the eyelids on the irrita-

<sup>1</sup> Those who wish to obtain further information as to these circumstances may be referred to my work *Bemerkungen über die Thätigkeit der automatischen Nerven-centra*, &c. Erlangen, 1875.

tion of the sensory nerves of the eye, sneezing on irritation of the mucous membrane of the nose, coughing on the irritation of the mucous membrane of the respiratory organ. Wherever sensory nerves are connected by nerve-cells with motor nerves, these reflex actions may occur. If an animal is decapitated and its toe is pinched, the leg is drawn up and contractions occur in it. The reflex actions are here accomplished through the nerve-cells of the spinal marrow, and the removal of the brain favours the action, while it at the same time excludes the possibility of the intervention of voluntary movements.

There is no doubt that in this process the nerve-cells play a part, and that the process does not depend solely on the direct transference of the excitement from a sensory nerve-fibre to an adjacent motor nerve-fibre. Apart from the fact that the transference never takes place except where nerve-cells can be shown to be present, this is confirmed by the fact that the process of reflex transference occupies a very noticeable time, much longer than that required for transmission through the nerve-fibres. With the knowledge which we have now gained of the structure of the central nervous organs, it may be considered established, that nowhere is there immediate connection between sensory and motor nerve-fibres, but a mediate connection through the nerve-cells. This allows the possibility of the propagation of an excitement from a sensory nerve-fibre, through a nerve-cell, to a motor nerve-fibre. It is thus intelligible how, owing to the interconnection of the nerve-cells, the passage of the excitement from any sensory nerve-fibre to any or every motor nerve-fibre is possible, for the excitement advances

from nerve-cell to nerve-cell, from each of which it can re-pass into a motor fibre. From the length of the time occupied by the reflex irritant, it is to be inferred that the transmission of the excitement has to meet considerable resistance in the nerve-cells. This resistance naturally increases with the number of nerve-cells to be traversed, so that the transference of a reflex action from a definite sensory fibre to different motor nerve-fibres is not always equally difficult, and is the more difficult the greater is the number of the cells which lie between the two. All this agrees with the facts found by experiment. It also explains why, by certain influences, not only is the reflex transference rendered easier, but the passage of the excitement to the most remote motor fibres is also rendered peculiarly possible. The best known case of this is poisoning by strychnine. This so greatly facilitates the reflex transference that the slightest touch on any point of the skin, or even the disturbance caused by a breath, is sufficient to throw all the muscles of the body into violent reflex tetanus.

As each excitement of a sensory fibre which reaches the nerve-centre can give rise to a conscious sensation, the spread of the excitement within the centre must have the same effect as would be the case if a larger number of excitements of several sensory fibres reached the centre simultaneously. This process, which, however, only occurs in the case of strong excitements, is called *co-relative sensation*. Sensation is caused not only by the excitement of the nerve-cell directly concerned, but also by the spread of the excitement to the other nerve-cells. It may also be spoken of as the radiation of the sensory irritant, because the excite-



ment seems to spread within certain limits from the point directly touched.

7. These phenomena will become more evident when we have more accurately learned the origin of conscious sensations in general, and the conceptions which depend on this. In order that such conscious sensations should result it seems absolutely necessary that the excitement should reach the main brain (*cerebrum*). Whether other parts of the brain, or even the spinal marrow, are able to give rise to conscious sensations is at least very doubtful, and is at any rate not proved.<sup>1</sup> But when the excitement reaches the brain, it gives rise not only to feelings, but also to very definite conceptions as to the nature of the excitement, its cause, and the locality at which it acts. It is true that sometimes this effect fails and the irritant does not reach consciousness, as, for example, when the attention is strongly attracted in some other direction,

<sup>1</sup> The dispute about the so-called 'mind in the spinal marrow' (*Rückenmarksseele*), the question, that is, whether more or less clear conscious conceptions can occur in the nerve-cells of the spinal cord, was long and hotly debated, but is now at rest. It appears to me that the whole form of the question is unscientific, for the question can simply not be solved with the means for research which we can command. Our own consciousness informs us as to our own sensations and conceptions, and we learn those of others from their lips. Where this fails, opinion is always untrustworthy, as, for example, where we try to infer the feelings of men from their behaviour. It is, however, yet more hazardous to attach importance to the movements of a brainless animal, and it is therefore not surprising that two observers should draw quite different conclusions from the same facts, one explaining them as simple reflections, the other being of opinion that such behaviour under such circumstances is only explicable as the result of conscious sensations and conceptions. The lower the animal is in the scale, the more untrustworthy, naturally, is the decision.

or as in sleep. The irritant can then elicit a reflex action, though there is no consciousness of this. That the origin of conscious conceptions is also an activity of the nerves is certain, and it is the cells of the grey matter of the brain which possess this activity. On the other hand, we are entirely unable even to indicate how this consciousness comes into being. It may be due to molecular processes in the nerve-cells which result from the received excitement; but molecular processes are but movements of the molecules, and though we can understand how such movements cause other movements, we are entirely unaware how these can be translated into consciousness.<sup>1</sup>

The excitements transmitted by the various sensory fibres do not all act in the same way on the brain, and the sensations to which they give rise differ. Accordingly, we may distinguish the various sensations of the various senses, and even within one and the same sense various sub-species, as the colours in the sphere of optical sensations, the various pitches in the sphere of auditory sensations. But as all the nerve-fibres which accomplish the various sensations differ in no way from each other, we are forced to look in the nerve-cells for the reason of the difference in sensations. Just as we assumed that motor nerve-cells differ from sensory, so we must further assume that among sensory nerve-cells, the excitement of which always elicits the conception of light, others again the excite-

<sup>1</sup> E. du Bois-Reymond has entered further into this question in his address to the assembly of naturalists at Leipzig (*Ueber die Grenzen des Naturerkennens*, Leipzig, 1872). Some of the younger natural philosophers seem inclined to avoid the difficulty by ascribing, as does Schopenhauer, sensation and consciousness to all molecules, but this does not seem to me to be any real gain.

ment of which always elicits the conception of sound, others again the excitement of which always results in the conception of taste, and so on. In entire accordance with this assumption is the fact that it does not matter what external cause effects the excitement of any one nerve-fibre, but that every excitement of a given nerve-fibre is always followed by a given sensation. Thus, the nerve of sight may be mechanically or electrically irritated, with the result of producing a sensation of light; mechanical or electric irritation of the auditory nerve effects a sound sensation; electric irritation of the nerve of taste effects just such a sensation of taste as does the influence of a tasted substance. It even happens that the exciting cause is situated in the brain itself and directly excites the nerve-cells, and the sensations which are thus elicited are indistinguishable from those which are effected through the nerves. To this are due the *subjective sensations*, hallucinations and so on, which depend on an alteration in the character of the blood, or on an increase in the sensitiveness in the nerve-cells.

Wherever the excitement occurs, whether in the nerve-cells themselves or anywhere in the course of the nerves leading to the cells, consciousness always refers the sensation to the presence of some external cause of excitement. If the nerve of sight is pressed, the patient believes that he sees a light external to his body; if a nerve of touch is irritated at any point in its course (e.g. the elbow-nerve at the furcation of the elbow-bones), the patient feels something in the nerves distributed in the skin (in our example in the two last fingers, and in the outer edge of the palm of the hand). Our power of conception therefore always



projects every sensation which reaches the consciousness outward, that is, to where the cause of the excitement is normally. This so-called *law of eccentric sensations* finds an easy explanation in the supposition that the conception of the locality of the efficient cause is gained from experience.<sup>1</sup> It will easily be understood that this necessarily follows from the characters which we have ascribed to the nerve-cells. When the nerve-cell is irritated, the same sensation and the same conception must always result. Just as it makes no difference in the case of a muscle whether the excitement conveyed to it by a motor nerve starts from a higher or from a lower point on the nerve, or whether the nerve has been irritated mechanically, electrically, or by the will, so the process in the nerve-cell does not depend on the locality or the nature of the excitement. When the circumstances which give rise to the irritation are abnormal, the result is an illusion of the senses, that is, a false cause is assigned to a perfectly clear and true sensation.

8. The nature of the last of the capabilities which we have attributed to the nerve-cells, the retardation of a motion, is still very obscure. The fact of retardation is as yet principally known in the case of automatic motion, though retardation of reflex action also occurs, as may be inferred even from the fact that the rise of reflex actions is hindered by the activity of the nerves, especially when this originates from the brain. The respiratory movements being of all automatic move-

<sup>1</sup> Details of this matter, into which we cannot enter further here, will be found in Bernstein's *The Five Senses of Man* (International Scientific Series, vol. xxi.), and in Huxley's *Elementary Physiology*.

ments the best known, it is on these that the current views as to the retardatory nerves are based. It has been explained in § 5 that the respiratory movements result from the excitement of the nerve-cells of the respiratory centre. These movements may be accelerated or retarded, though all the other conditions remain unchanged, if certain nerve-fibres which pass from the mucous membrane of the air-passage to this respiratory centre are irritated. These retardatory nerves are distinguished from those which pass to the heart by the fact that it is not known whether the latter pass to the muscles of the heart or to the nerve-cells situated in the heart, a doubt which is satisfied in the case of the former by their anatomical arrangement. Of the retardatory fibres of the heart it might be supposed that they in some way incapacitate the muscle from contracting; in the case of the retardatory nerves of the respiratory system such supposition may be at once rejected, for they are in no way in contact with the respiratory muscles. The only possible explanation is therefore, that the retardatory nerves act on the nerve-cells in which the excitement is generated, thus either preventing the excitement from even coming into existence, or preventing the excitement from passing from the nerve-cells in which it is generated to the appropriate motor nerve-cells. For various reasons the latter view has been preferred. It is supposed that the automatically acting ganglion-cells are not directly connected with the appropriate nerve-fibres, but that conducting intermediate apparatus are present between the two, and that these offer a great resistance. This explains both the occurrence of the rhythmic motions and the retardation. The latter,

that is, is due to an increase in the resistance by which the motion is temporarily suspended.<sup>1</sup>

Retardatory nerves have been recognised in almost all automatic apparatus, and all are accounted for by the above explanation. The same explanation may also be applied at once to the retardation of reflex action; for even in the passage of the excitement from the sensory to the motor nerves very great resistance has to be overcome, and an increase in this resistance must prevent the passage of the excitement and thus hinder reflex action. Our acquaintance with this subject is, however, not yet by any means complete, and a final opinion on the matter is therefore for the time impossible.

I will only mention further that the opposite effect, the facilitation of the passage of the excitement from the nerve-cells in which it originates, to the peripheric nerve-courses, appears to occur.

Finally, it is sometimes observable that when those portions of the nerves which contain nerve-cells are continually and regularly irritated, a rhythmic or even an irregular movement results, instead of a regular tetanic contraction of the muscles concerned,—a circumstance which is evidently to be explained in the same way as rhythmic automatic activity. The regular excitement having to pass through nerve-cells is modified by the great resistance present in these, and is transformed into a rhythmic motion, while when the nerve and the muscle are directly connected, the latter responds to a continuous excitement of the nerve with a regular and continuous contraction.

<sup>1</sup> See my account of the automatic nerve-centres, to which reference has already been made.



9. From all these details it is very evident that the nerve-fibres are homogeneous the one with the other, and that the difference in their effects is to be referred to their connection with nerve-cells of varied form. This seems, however, to be opposed to the fact that the different sense-nerves are irritable by quite different influences, and each of them only by quite definite influences—the nerve of sight by light, the nerve of hearing by sound, and so on. It would, however, be a mistake to infer from this that the nerve of sight is really different from the nerve of hearing. If the matter is examined more closely, it appears that the nerve of sight cannot be excited by light. The strongest sunlight may be allowed to fall on the nerve of sight without producing excitement. It is not the nerve, but a peculiar terminal apparatus in the retina of the eye with which the nerve of sight is connected, which is sensitive to light. The case of the other sense-nerves is similar; each is provided at its peripheric end with a peculiar receptive apparatus, which can be excited by definite influences, and which then transmits these influences to the nerves. On the difference in the structure of these terminal apparatus depend which influences have the power of exciting them. When the excitement has once entered the nerve it is always the same. That it afterward elicits different sensations in us, depends again on the character of the nerve-cells in which the nerve-fibres end. Supposing that the nerves of hearing and of sight of a man were cut, and the peripheric end of the former were perfectly united with the central end of the latter, and contrariwise that the peripheric end of the nerve of sight were perfectly united with the central

end of the nerve of hearing, then the sound of an orchestra would elicit in us the sensation of light and colour, and the sight of a highly coloured picture would elicit in us impressions of sound. The sensations which we receive from outward impressions are therefore not dependent on the nature of these impressions, but on the nature of our nerve-cells. We feel not that which acts on our bodies, but only that which goes on in our brain.

Under these circumstances it may appear strange that our sensations and the outward processes by which they are evoked are so entirely in agreement; that light elicits sensations of light, sound sensations of sound, and so on. But this agreement does not really exist; its apparent existence is only due to the use of the same name to express two processes which have nothing in common. The process of the sensation of light bears no likeness to the physical process of the ether vibrations which elicit it; and this is evident even in the fact that the same vibrations of ether meeting the skin elicit an entirely different sensation, namely, that of warmth. The vibrations of a tuning-fork are capable of exciting the nerves of the human skin, and then they are felt; they may excite our auditory nerves, and then they are heard; and under certain circumstances they may be seen. The vibrations of the tuning-fork are always the same, and they have nothing in common with the sensations which they elicit. Though the physical processes of the vibrations of ether are called, sometimes light, and at another time heat, a more accurate study of physics shows that the process is the same. The usual classification of physical processes into those of sound, light, warmth, and so on,

is irrational, because in these processes it gives prominence to an accidental circumstance, that is, to the way in which they affect human beings, who are endowed with various sensations, while in other, such as magnetic and electric processes, it is based on quite different marks of classification. Scientific study of the physical processes on the one hand, and of the physiological processes of sensation on the other, exposes this error, which penetrates further owing to the fact that language uses the same words for the different processes, thus making their distinction harder.

Language is, however, but the expression of the human conception of things, and the conception of the innate identity of light and the sensations of light, of sound and of the sensation of sound, and so on, was regarded till quite recently as incontrovertibly true. Goethe<sup>1</sup> gave expression to this in the lines—

Wär' nicht das Auge sonnenhaft,  
Die Sonne könnt' es nie erblicken ;  
Läg' nicht in uns des Gottes eigne Kraft,  
Wie könnt' uns Göttliches entzücken !

Plato expresses himself in the same way in the 'Timæus.' On the other hand, Aristotle held correct conceptions on the subject. But it is only since the researches of Johannes Müller laid new ways open to science that these conceptions have gained a scientific foundation, and have been brought in all points into harmony with the facts, so that they have now become the basis of the physiology of the senses and the psychology of the present day.

One expression of the erroneous views once prevalent is to be found in the theory of so-called *adæ-*

<sup>1</sup> *Zahme Xenien*, iii. 70.



*quate irritants*, according to which there is such a sufficient irritant for each sense-nerve, that is, an irritant in its nature adapted to the nature of the sense-nerve, and that this was alone able to excite it. We know now that this is not true. Yet the expression may be used to indicate the irritants which are especially able to act on the terminal organs of the nerves.

In the same way we may look upon the idea of so-called *specific energies* of the sense-nerves, if by this it is intended to express any character of the nerves, as disproved. But we must ascribe specific energies to the individual nerve-cells in which the sensations are originated. It is these alone which are able to produce in us different kinds of sensation. If all the nerve-cells of the sensations were alike, sensations could indeed be elicited in us by the influence of the outer world on our sense organs; but these would only be of one and the same kind, or at most it could only be in the strength of this one undefined sensation that differences would be perceptible. There may be animals which are only capable of such a single undefined sensation, their nerve-cells being all alike and not yet differentiated. Such animals would be able to form a conception of the outer world as distinguished from their own bodies, that is, they would be able to evolve self-consciousness; but they would not be able to attain a knowledge of the processes in the outer world. The development of such knowledge in us is greatly assisted by a comparison of the different impressions brought about by the different organs of the senses. A body presents itself to our eye as occupying a certain space, being of a

certain colour, and so on. By tasting we may gain further conceptions of this body. If it is out of reach of our hands, by approaching it we may observe how the apparent size of the body, as the eye shows it to us, increases as we approach. These and many thousand other experiences which we have gained since our earliest youth have gradually put us in a position to form conceptions as to the nature of a body merely from a few sensations. In this act many complete inferences are unconsciously involved, so that that which we believe to have been directly perceived is really known by inference from many sensations and from a combination of former experiences. For instance, we think that we see a man at a certain distance; really, however, we only feel a picture of a certain size of the man on our retina. We know the average size of a man, and we know that the apparent size decreases with the distance; moreover, we feel the degree of contraction of the muscles of our eye which is necessary to direct the axis of our eye to the object and for the adjustment of our eye to the necessary distance. From all these circumstances, the opinion, which we erroneously regard as a direct sensation, is formed.

10. We have already (chap. iv. § 2; chap. vii. § 3) made acquaintance with the methods by which Helmholtz measured the details of the time occupied by the contraction of the muscle and the propagation of the excitement in the motor nerves. By the same, or very similar methods, Helmholtz, and others after him, determined the propagation of the excitement in sensory nerves, and found that it was about 30 m. per second, and therefore, at nearly the same rate as in the

motor nerves of men. More than this has been done: the time has been measured which is requisite for an irritant conducted to the brain to be transmuted into consciousness. Such determinations, in addition to their theoretical value, are of practical interest to observing astronomers. In observing the passage of stars on the meridian and comparing the passage seen through the telescope with the audible beats of a second-pendulum, the observer always admits a slight error, dependent on the time which the impressions on the two senses require to reach the state of consciousness. In two different observers this error is not of exactly the same value; and in order to render the observations of different astronomers comparable with each other, it is necessary to know the difference between the two cases, the so-called *personal equation*. In order to refer the observations made by each individual to the correct time, it is necessary to determine the error which is made by each individual.

Let us suppose that an observer sitting in complete darkness suddenly sees a spark, and thereupon gives a signal. By a suitable apparatus, both the time at which the spark really appeared and that at which the signal was given are recorded. The difference between the two can be measured, and it is called the *physiological time* for the sense of sight; the physiological time for the sense of hearing and for that of touch may be determined in the same way. Thus Professor Hirsch, of Neufchatel, found—

In the case of the sense of sight	0·1974 to	0·2083 sec.
„	„	hearing 0·194
„	„	touch 0·1733

When the impression which was to be recorded was



not unexpected, but was known beforehand, the physiological time proved to be much shorter; in the case of the sense of sight it was only from 0·07 to 0·11 of a second. From this it follows that, in the case of excitement the advent of which is expected, the brain fulfils its work much more quickly.

Certain experiments made by Donders are yet more interesting. A person was instructed to make a signal, sometimes with the right hand, sometimes with the left, according as a gentle irritant applied to the skin was felt in one place or the other. If the place was known, the signal succeeded the irritant after an interval of 0·205 of a second, but if the place was not known, only after an interval of 0·272 of a second. The psychological act of reflection, as to where the irritant occurred, and that of the corresponding choice of the hand occupied, therefore, a period of 0·067 of a second.

The physiological time in the case of the sense of sight was somewhat dependent on colour; white light was always noticed somewhat sooner than red. If the observer knew the colour which he was to see, he gave the signal sooner than when this was not the case and he had first to reflect as to what he had seen before he gave the signal. In such experiments, the observer always forms a preconception of the colour which he expects to see. If the colour when it becomes observable corresponds with that which he expected, the reaction in the observer takes place sooner than when this is not the case.

Similar observations were made in the case of the sense of hearing: the recognition of any sound heard follows sooner when it is known beforehand what sound is to be heard than when this is not the case.

This sluggishness of the consciousness, if we may so call it, is exhibited in another way in certain experiments instituted by Helmholtz. The eye sees a figure, which is immediately followed by a bright light; the more powerful the latter is, the longer must the first have been seen, if it is to be recognised at all; moreover, complex figures require more time than simpler. If letters are seen lighted up on a bright ground for a very short time, no other light following, a shorter time is necessary for the recognition, the larger are the letters and the brighter the illumination.

It is true that it is only very simple brain activities the origin of which can be in any way made clearer by such experiments as these; but yet these are the rudiments of all mental activity—sensation, conception, reflection, and will; and even the most elaborate deduction of a speculative philosopher can only be a chain of such simple processes as those which we have been observing. These measurements, therefore, represent the beginnings of an experimental physiological psychology, the development of which is to be expected in the future. It seems to me that remunerative study of the processes in nerve-cells must start from the very simplest phenomena. Results are, therefore, to be first looked for in the study of the processes of reflection; possibly these will prepare the ground on which at some future time a mechanism of the nervous processes may be built. ‘In truth,’ says D. F. Strauss, in ‘The Old and the New Faith,’ ‘he who shall explain the grasp of the polyp after the prey which it has perceived, or the contraction of the insect larva when pierced, will indeed be yet far from having in this comprehended human thought, but he will be on the way to do so, and

may attain his end without requiring the help of a single new principle.' Whether this end will ever be attained is another matter. But we can always gain fuller knowledge of the conditions under which it may come to pass, and of the mechanical processes which form its first principles. Such is the lofty aim after which the science of the General Physiology of Muscles and Nerves strives—an aim worthy of the labour of the noblest.



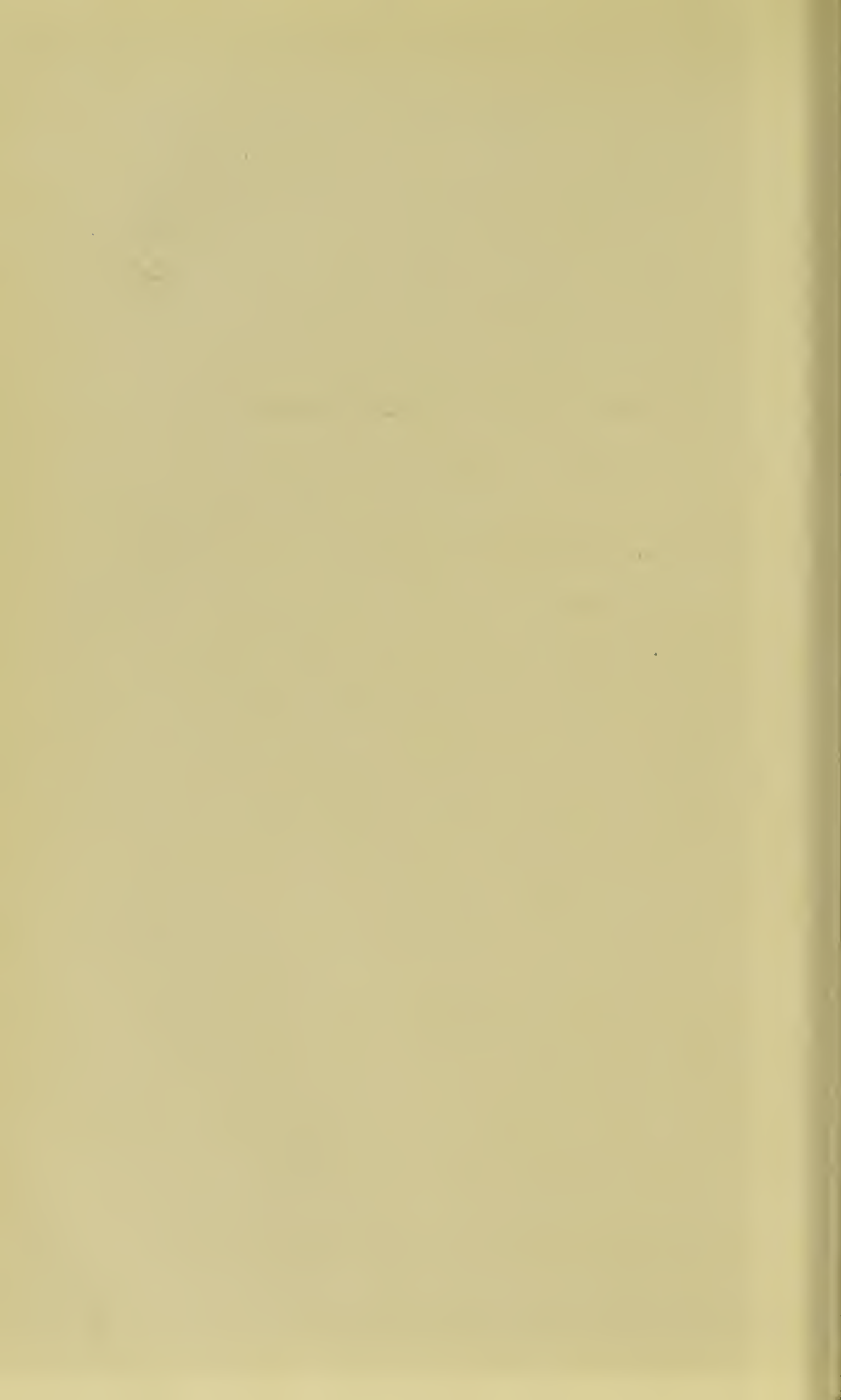

## NOTES AND ADDITIONS.



### I. GRAPHICAL REPRESENTATION. IDEA OF MATHEMATICAL FUNCTION (p. 49).

The method employed in fig. 16 of representing by a sign the dimensions of the expansion relatively to the amount of the expanding weights, admits of such a variety of applications, and will be used so frequently, that a brief explanation of it may not be out of place here.

When two series of values bear such a relation the one to the other that each value of one series corresponds with a definite value in the other, mathematicians speak of the one value as the function of the other. This relation may always be exhibited in tabular form, as in the following example:—

1	2	3	4	5	6	7	8	9	10
2	4	6	8	10	12	14	16	18	20

The relation which prevails in this case is very simple. Each number in the upper series corresponds with a number in the lower, and the latter is always double the value of the former. Representing the numbers in the upper series by  $x$ , those in the lower by  $y$ , the relation between the two series of numbers may be expressed in the formula :

$$y = 2x$$

This formula expresses the same and even more than the

table. Substituting for the unknown  $x$ , which may represent any number, the number 4, then the table expresses that the value of the corresponding  $y$  is 8. If  $x=5$ , then the table expresses that  $y=10$ . But when the value of  $x$  is intermediate between 4 and 5, e.g. 4.2371, the table does not help us; but by the use of the formula the value of the corresponding  $y$  may easily be found; it is  $= 8.4742$ .

The formula may be reversed, and written thus :

$$x = \frac{1}{2}y,$$

that is to say, for any given value of  $y$  we may calculate the corresponding value of  $x$ . It is exactly the same in the case of the similar formula :

$$y = 3x,$$

which may also be written thus :

$$x = \frac{1}{3}y.$$

In this case, therefore, with each given value of  $x$  corresponds a certain value of  $y$ , the latter being three times the value of the former. In the two corresponding formulæ

$$y = a x \text{ and } x = \frac{1}{a}y,$$

is a somewhat wider expression to this kind of relation; in this case  $x$  and  $y$  are again the signs of the two corresponding series of numbers,  $a$  expresses a definite figure which is to be regarded as unchangeable within each particular case. In our first example  $a=2$ , in our second example  $a=3$ , and similarly in any other instance  $a$  may have any other value.

Looking now at the following table :

1	2	3	4	5	6 etc.
1	4	9	16	25	36 etc.

we see that any number in the lower series is found by multiplying the corresponding number in the upper series by itself, as may be expressed in the formula

$$y = x x \text{ or } y = x^2$$



This formula when reversed appears thus :

$$x = \sqrt{y}.$$

Provided with a formula of this sort, which expresses the mutual relation of two corresponding series of values, it is always possible to draw out a table, though, on the contrary, the relation laid down in the table cannot always be expressed in a formula, for the relations are not always as simple as in our examples. Generally the values which are treated in the table are such as have been found by observations, as for instance in our case, the expansion of the muscle caused by various weights. With each weight an expansion corresponds, and this is found by experiment and may be expressed in tabular form, thus :

Weight:	50	100	150	200	250	300	gram.
Expansion :	3.2	6	8	9.5	10	10.5	mmt.

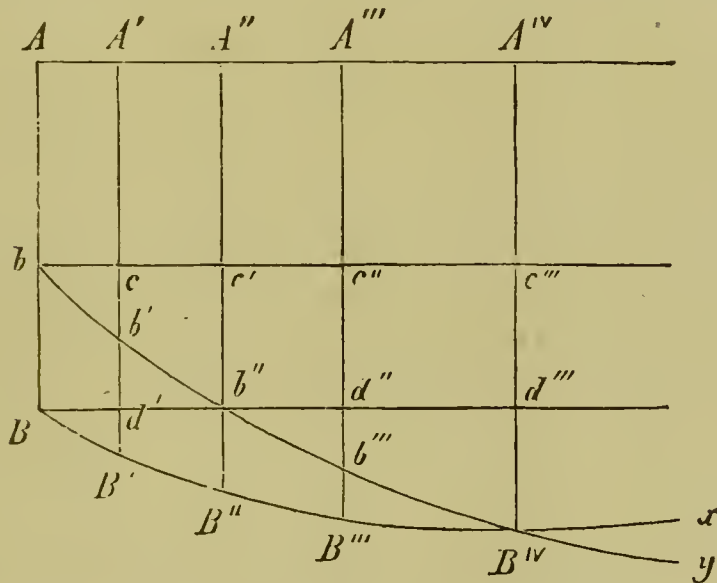

FIG. 69. GRAPHICAL REPRESENTATION OF MUSCLE-EXPANSION.

All that is shown by the table is that the expansion does *not* increase proportionately with the weight (as would be the case in inorganic bodies), but increase in a continually decreasing proportion. But any required function-character, whether it is expressed by a comparison or in a table drawn up on the basis of observations, may be diagrammatically

shown by a method first employed by Descartes, which it is our present object to explain.

The amounts treated may be of the most varied kinds: numbers, weights, degrees of warmth, the number of births or deaths, and so on. In all cases the amount may be diagrammatically shown by the length of a line. If a line of a certain length represents any given amount, then double this amount is represented by a line twice the length of the former. It does not matter what is the standard selected; but when once selected it must not be varied in the same representation. Two lines are drawn at right angles to each other; from the point of section *B* (fig. 69) the lengths which are to represent the values of one series (in our case, the weights attached to the muscle) are measured off on the

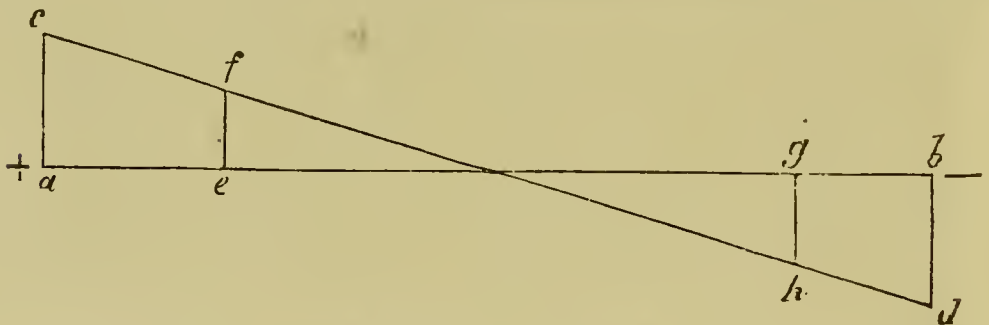

FIG. 70. DIAGRAM OF POSITIVE AND NEGATIVE VALUES.

horizontal line. From each of the points thus obtained,  $d'$ ,  $b''$ ,  $d''$ ,  $d'''$ , a line is drawn at right angles to the first, care being taken to make its length express the expansion corresponding with each weight respectively. This gives the lines  $d' B'$ ,  $b'' B''$ ,  $d'' B'''$ ,  $d''' B^{iv}$ . By connecting these points we obtain the curve  $BB' B'' B''' B^{iv} x''$ , which at a glance shows the relation between the weight and the expansion. In exactly the same way the curve  $b b' b'' b''' B^{iv} y$  is projected, and this represents the expansion of the active muscle by the corresponding weights.

In many cases it is required to represent values of opposite kinds. If, for example (fig. 70), the wire  $a b$  is traversed by an electric current, then one half assumes positive tension, the other negative tension. To express this, the

lines which are to represent positive tension are drawn upward, those which are to represent negative tension downward, from the basal line. The figure then shows that the tension in the middle of the wire = 0, and that toward the left the positive, toward the right the negative, tensions increase regularly. In order to find the amount of the tension prevailing at any particular point, e.g. at *e*, a perpendicular line is erected at that point; and the length of this, *ef*, accurately represents the tension there prevailing.

## 2. DIRECTION OF THE MUSCLE-FIBRES, HEIGHT OF ELEVATION, AND THE ACCOMPLISHMENT OF WORK (p. 93).

Because of the extreme rarity of long parallel-fibred muscles, it is interesting to examine more closely the influence which oblique arrangement of the fibres exercises on their force, height of elevation, and on the work which they accomplish. When a muscle-fibre is so arranged that it is incapable of effecting a movement in the direction of its own contraction, only a part of the force of tension which is generated in it by its contraction comes into play, and this part may be easily found by the law of the parallelogram of forces. This is the case in all simply and doubly penniform muscles. Supposing that the muscle-fibre *AB* (fig. 71) contracts to the extent *Bb*, but that motion of the point *B*, on account of the attachment of the muscle to the bone, and of the nature of the sockets of the latter, can only occur in the direction *BC*; in that case the muscle-fibre, in contracting, undergoes a change in direction from its fixed point of origin *A*, and thus assumes the position *Ab'*; the elevation which is really effected is,

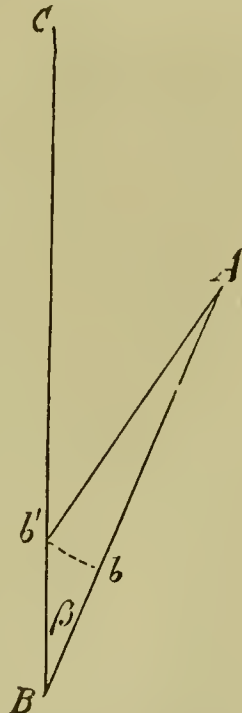

FIG. 71. ACTION OF OBLIQUE MUSCLE-FIBRES.



therefore,  $B b'$ . The small triangle  $B b b'$  may be regarded as a right-angled triangle. This gives

$$Bb' = \frac{Bb}{\sin \beta}.$$

The force with which the muscle-fibre strives to contract in the direction  $A B$  being called  $k$ , only part of this force, the component  $k'$  lying in the direction  $B C$ , finds expression. According to the law of the parallelogram of forces, this component is

$$k' = k \sin \beta.$$

This force may be regarded as proportionate to the weight which the muscle-fibre is able to raise to the given height of elevation. If we then calculate the work which the muscle can accomplish, we find, if the motion can take place in the direction  $A B$ ,

$$A = Bb k;$$

but if motion can only occur in the direction  $B C$ ,

$$A = Bb' k' = \frac{Bb}{\sin \beta} k \sin \beta = Bb k.$$

The value in the two cases is therefore exactly the same, or, in other words, the amount of work accomplished by the muscle is quite independent of the direction in which its action takes place. This is, naturally, true of every other muscle-fibre, and, consequently, of the whole muscle. The statements which we have made of parallel-fibred muscles are therefore also true of those of which the fibres are irregular. The possible height of elevation is always greater the longer the fibres are, and the force proportionate to the diameter or to the number of the fibres. In oblique-fibred muscles the fibres are generally very short, but very numerous; these must, therefore, whatever their accidental form, be regarded as short and thick muscles, possessed of small elevation and great force.

### 3. EXCITABILITY AND STRENGTH OF IRRITANT. COMBINATION OF IRRITANTS (p. 119).

When the coils of a sliding inductive apparatus are brought nearer together, the strength of the inductive current does not increase in exact proportion with the decreasing distance between the two, but in a complex way, which must be provided for in each apparatus separately. Fick, Kronecker, and others have shown methods by which this calibration of the apparatus may be accomplished. If the real strength of the irritating current is compared with the height of the pulsation which it elicits, it appears that when the current is very weak no action is observable; action first appears, in the form of a slight, just visible pulsation, when the current has reached a certain strength, greater or less according to the condition of excitability of the nerve. As the currents increase further in strength, the heights of elevation increase in exact proportion to the strength of the currents, till a certain maximum has been reached. If the strength of the current becomes yet greater, the pulsations remain constant for a time; but then they again increase and reach a second maximum, above which they do not pass.

These so-called 'over maximum' pulsations are due to a combination of two irritants. An inductive shock is, as we have seen, a very brief current, in which the commencement and the end succeed each other very rapidly. For reasons which will be further explained in Note 7, the commencement of an inductive current is a more powerful irritant than its end. As long, therefore, as the current does not pass a certain strength, only the commencement of the current irritates; but in the case of very powerful currents the end may be sufficiently effective: this gives two irritations following each other in rapid succession, and these

together effect a greater pulsation than does a single irritation.

If more than two irritants follow each other in rapid succession, tetanus results, as we know. In this case also the height of elevation is always greater than that which can be attained by a single pulsation. For the muscle has the power of being again irritated even when it is already in the act of contraction, a more powerful contraction being thus induced in it. The bearing of these facts on the case of nerve is that the separate excitements effected in it by these rapidly successive irritations do not mutually disturb each other, but are transmitted one after the other, in the sequence in which they originate, to the muscle on which they act. But when the number of the irritants becomes too great, the nerve-molecules are no longer able to keep pace with the rapidly succeeding shocks, and the nerve is unexcited. The limit at which this intervenes has, however, not yet been determined with any certainty. It appears to lie at between 800 to 1000 irritants per second.

#### 4. CURVE OF EXCITABILITY. RESISTANCE TO TRANSMISSION (p. 123).

The increased excitability at the upper parts of the uninjured sciatic nerve, when not severed from the body, which, on the strength of our earlier experiments, we have assumed in the text, has recently been again defended by Tiegel against various objections. For reasons explained in the text it is inadmissible to infer an avalanche-like increase in the irritation merely from this higher excitability of the upper parts. Beside the experiments of Munk alluded to on page 116, there are other experiments from which a resistance to transmission in the nerve may be inferred. Such a resistance, weakening the irritant during its propagation, and an avalanche-like increase in the irritant, are irreconcilable contradictions which mutually exclude each



other. If resistance to transmission can be shown, then the irritation cannot increase in strength during its propagation through the nerve. I will, therefore, here briefly mention the reasons which induce me to declare in favour of one, and against the other, of these assumptions.

As is mentioned on p. 141, transmission becomes considerably harder when the nerve is in an anelectrotonic condition, and in strong anelectrotonus it is even rendered altogether impossible. It is natural to regard this greater difficulty as an increase of a resistance already present. A more important reason is however to be found in the phenomena which occur in reflex actions. If a sensory nerve is irritated, the excitement can be transmitted to the dorsal marrow and the brain, where it may be transferred to a motor nerve (*cf.* p. 274). This transference always occupies a considerable time, which I call reflex-time. If a sensory nerve is irritated sufficiently to cause a powerful reflex action (called a 'sufficient irritant'), if the reflex-time in this case is determined, and if irritants of continually increasing strength are then allowed to act on the same point in the nerve, then the reflex-time is found to become continually shorter. If, however, a point in the nerve lying very near the dorsal marrow is irritated, then even in the case of a 'sufficient irritant' the reflex-time is short. It is evident that the duration of the reflex-time depends on the strength of the irritant when it reaches the dorsal marrow. The irritant which comes from the point in the nerve adjacent to the dorsal marrow is but slightly affected; but that coming from a more remote point is weakened; so that a much stronger irritant must be applied to these more remote points, if an equally short reflex-time is to be attained.

It is true that these observations have been made with sensory nerves. But owing to the entirely similar character exhibited by all kinds of nerve-fibres in all points, where comparison is possible, we are justified in applying the views thus gained to the motor-nerves. It is, at all events, im-

probable that in one nerve-fibre a resistance to transmission exists, and in another an avalanche-like increase. All the facts are more easily and simply explained by assuming that there is a resistance to transmission in all nerves, allowance being at the same time made for the difference in the excitability of different points in the nerve.

Moreover the curve of excitability in the case of the sciatic nerve is not a simple ascending line from the muscle to the dorsal marrow. This nerve is found, as is shown in fig. 72, by the union of several roots; it then, at various

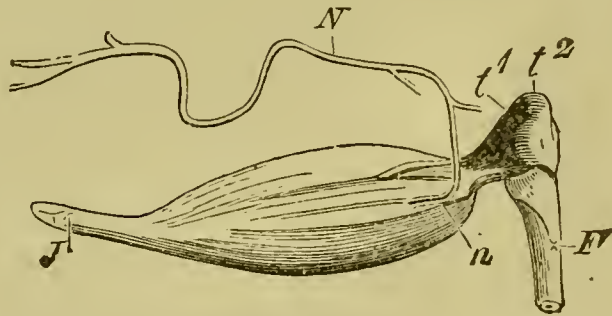

FIG. 72. THE SCIATIC NERVE AND CALF-MUSCLE OF A FROG.

points, gives off branches which enter the muscles of the upper leg, and then separate into two branches, one of which provides for the calf-muscle (*gastrocnemius*), the other for the flexor muscle of the lower leg. If various points of this nerve are irritated in the living animal, the nerve having been merely exposed and isolated from the surrounding parts, but not separated from the dorsal marrow, it is very evident that the excitability at the upper points is generally greater than at the lower; but points are also found in the course of the nerve at which a greater excitability exists than at the points above and below, as also, on the contrary, a less excitability than at the adjacent points. Such irregularities are most abundantly exhibited at the points where nerve-branches separate from the main trunk, especially when these branches have been cut away. This is partly due to electrotonic influences (*cf.* p. 125 *et seq.*; p. 215 *et seq.*, Note 13). The nerve-fibres which are cut generate a current which

passes through those which are not cut off, those the excitability of which is tested, and alters their excitability. This influence changes in the whole mass, as the cut nerves die, thus giving rise to irregularities the further nature of which we need not trace.

##### 5. INFLUENCE OF THE LENGTH OF THE PORTION OF THE NERVE EXCITED (p. 138).

If the irritant remains the same, the longer is the portion of the nerve irritated, the stronger is the action on the muscle. If the excitability of a portion of the nerve is found by the method of minimum irritants, that is, if the weakest irritant capable of effecting an observable pulsation is looked for, and if various degrees of excitability prevail in the portions of the nerve simultaneously exposed to the irritant, action may result, even if only a part of the portion of nerve is really excited; in reality, therefore, it is but the excitability of the most excitable part of the whole nerve-portion which is tested. In a fresh nerve this is generally the upper part of the nerve-portion. But when there is no great difference in excitability within the nerve-portion, then every part of the portion will be excited by an irritant of a certain strength in an approximately like manner, and the action observed in the muscle will therefore be the combined effect of the excitement of the separate parts of the nerve-portion. But if, as we have assumed, the loss of excitability in each part follows the highest excitability very suddenly, the effect must be that the portion actually irritated continually becomes shorter; the parts which are irritated are however still in the highest state of excitability, and therefore exhibit the third stage of pulsation (the testing current having been so chosen that, in the fresh nerve, it originally produced the first stage). The form in which the third stage exhibits itself—pulsation on the closing of a descending current and on the opening of an ascending current—must therefore remain



unchanged, but the pulsations must gradually decrease in strength, and all effect must finally disappear, just when the maximum of excitability, and the death which follows this, pass the lower limit of the excited portion.

6. DIFFERENCE BETWEEN CLOSING AND OPENING INDUCTIVE CURRENTS. HELMHOLTZ'S ARRANGEMENT (p. 151).

When an electric current is suddenly closed in a spiral, this not only acts inductively on a neighbouring spiral, but the individual coils of the primary spiral act inductively on each other; an analogous effect would occur on the opening, but that the sudden interruption of transmission prevents the development of this opening inductive current in the primary coil. The inductive current which originates on the closing of the current being in an opposite direction to the closed current itself, the former must weaken the latter; the current can therefore attain full strength, not at once, but only gradually; but on the opening the current suddenly ceases. This difference in the duration of the closing and opening of the primary current corresponds with differences in the currents induced by them in the secondary spiral, which are used for the irritation of the nerve. Figure 73 exhibits these characters. The upper part of the figure represents the temporal course of the main current in the primary spiral of an inductive apparatus; the lower part represents the temporal course of the induced currents in the secondary spiral. The line  $o \dots o \dots t$  represents the duration. The primary current is closed at the moment  $o$ . Were the retardatory influence which has been mentioned not present in the primary spiral, the current would at once attain its full strength  $OJ$ ; but owing to that influence it attains this strength only gradually, somewhat as shown by the crooked line 3. With this gradually occurring current corresponds a closing inductive current in the secondary spiral, as is represented by the curve 4;

the curve is drawn downward from the time-line  $o \dots o \dots t$ , to indicate that the direction of this induced current is opposed to the direction of the primary current. If the primary current is interrupted, it suddenly falls from the

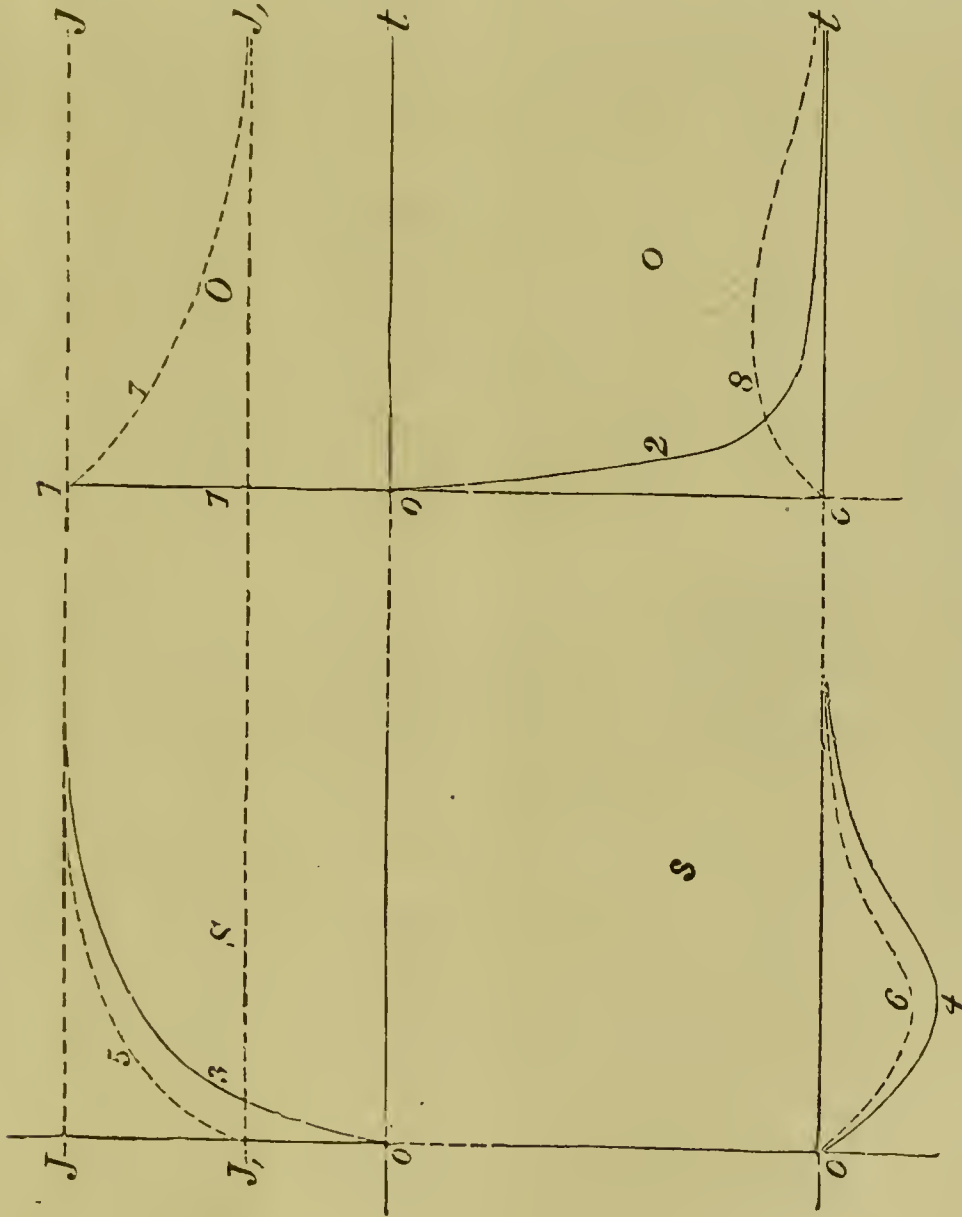

FIG. 73. DURATION OF INDUCTIVE CURRENTS.

strength  $J$ , as indicated by the straight line 1. With this fall corresponds an inductive current, which suddenly rises very abruptly and again falls somewhat less abruptly, as shown in curve 2. From this it is evident that the latter must be physiologically much more effective than the former.

Occasionally it is desirable to remove this difference, and to provide two inductive currents which flow and act nearly in the same way. This may be managed, if, instead of closing and interrupting the current of the primary coil, an additional closing wire offering small resistance is provided, and the interruption is effected in this. If this additional apparatus is present, only a very small part of the current passes through the primary coil. The strength of this part is indicated by  $J_1$ . When the closing in the additional apparatus is interrupted, the primary current slowly increases in strength from  $J_1$  to  $J$  as shown by the dotted curve 5; with this increase corresponds an inductive current in the secondary coil, as represented by curve 6. If the closing of the additional apparatus is once more effected, the current in the primary coil sinks in strength from  $J$  to  $J_1$ ; but the so-called *extra current*, that which originates in consequence of the sinking in the primary coil, is now able, the coil being closed, to take effect, and, as its direction is the same as that of the main current, it retards the sinking of the latter, so that this now takes place as indicated by curve 7; and with this slow sinking of the main current corresponds an inductive current in the secondary coil, such as is shown by curve 8.

Helmholtz made an alteration in du Bois-Reymond's sliding inductive apparatus by means of which this additional closing and opening is automatically accomplished. He adapted Wagner's hammer for this purpose, as shown in fig. 74. The current of the apparatus  $K$  passes through the wire arranged between  $g$  and  $f$  to the primary coil  $c$ , from this to the coils round the small electro-magnet  $b$ , and from the latter through the column  $a$ , back to its original starting point. The electro-magnet attracts the hammer  $h$ , in consequence of which a small platinum plate fastened below the German silver spring is brought into contact with the platinum point of the screw  $f$ , thus completing a brief and efficient additional closure  $g, f, a$ . The consequence of this



is that the current in the coil *c*, and at the same time in the electro-magnet, is much weakened; the latter can no longer attract the hammer, which springs upward, so that the plate is removed from the point *f*, and the additional closure is interrupted. The current once more passes in full strength through the coil *c* and the electro-magnet *b*, the hammer is again attracted, and the whole process is repeated as long as the circuit *K* endures. If it is required to restore the appa-

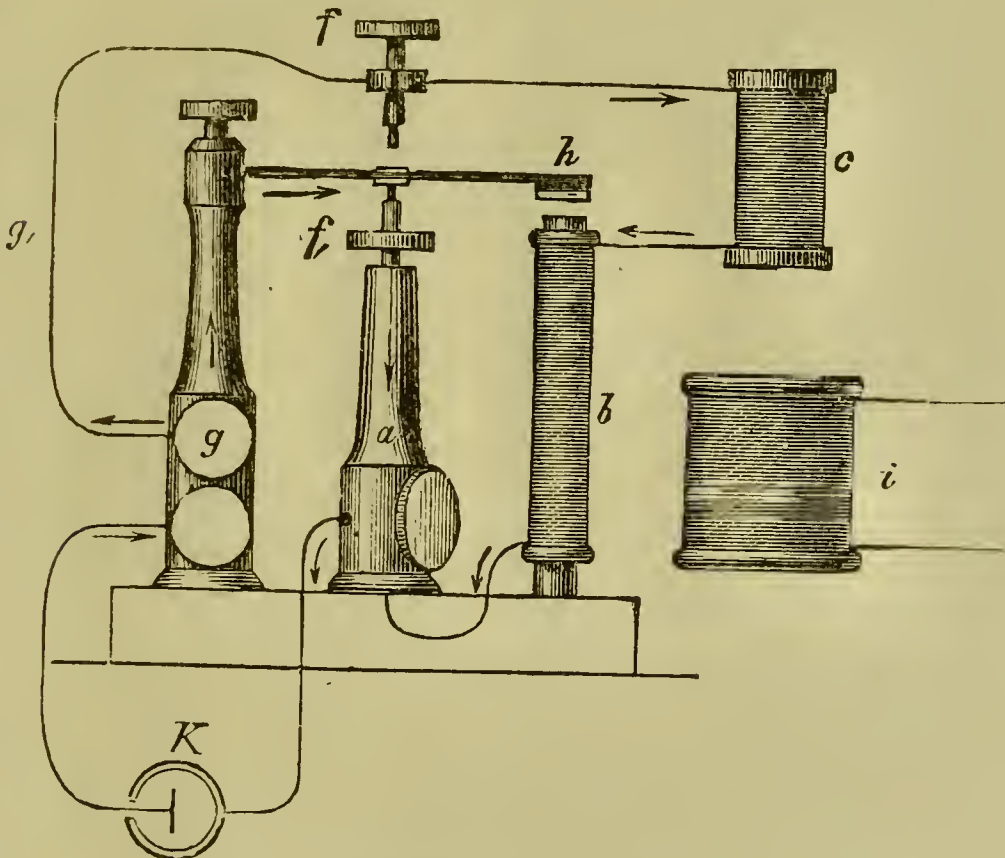

FIG. 74. HELMHOLTZ'S APPARATUS.

ratus to its original condition, it is only necessary to remove the wire *g*, and to lower the point *f*.

## 7. ACTION OF CURRENTS OF SHORT DURATION (p. 152).

Either the closing or opening of a continuous current or an inductive current is used to excite the nerve. In the latter case, however, as has already been indicated in Note

3, we have really to do with a closing immediately succeeded by an opening, for the inductive current arises and again disappears as soon as it has reached a certain strength. This may be imitated with suitable apparatus, by closing a constant current for a very brief time. Such a 'current shock' may exhibit exactly the same phenomena as does an inductive current. If its duration remains unaltered, but the strength of the current is gradually increased, the height of elevation at first increases, remains for a time at a first maximum, after which it again increases and reaches a second maximum. The explanation is the same as was given in Note 3 for inductive currents. At first only the beginning of the current (the closing) acts excitingly; but when the current is stronger, the cessation of the current (the opening) can also act in the same way, and a combination of the two irritants can be formed.

If the duration of such a current-shock is very short, the current must be stronger, if it is to exercise any exciting effect at all, than would be necessary if the duration were longer. It is evident that a current, if it lasts too short a time, cannot effect a sufficient change in the molecular condition of the nerve, and weaker currents require a longer time to do this than stronger.

From the curves in fig. 73 which represent the duration of inductive currents, it appears that without exception the commencement of the current results more abruptly than its disappearance. The commencement of every inductive current must therefore more easily excite than does its end, especially as this is always the case even in the ordinary closing and opening of every constant current, in which such considerable differences in the duration do not occur. In the case of weak inductive currents it is always only the commencement which is active, in other words *an inductive current acts as does the closing of a continuous current*. Now let us suppose that an inductive current is passed through a nerve in an ascending direction. So long as the

current does not exceed a certain strength, it can excite; but when it is strong it is ineffective, since the closing of strong ascending currents is always ineffective. If, however, the current is made yet stronger, it may again become effective, because the opening portion of the current can now, in spite of its retarded course, cause an irritation. This gap (*Lücke*) in the action was observed by Fick, and afterwards by Tiegel. How far other causes besides those here explained combine to produce this peculiar phenomenon, we cannot examine further here.

#### S. ACTION OF TRANSVERSE CURRENTS. UNIPOLAR IRRITATION (p. 152).

If a current is passed transversely through a nerve, that is, in a direction at right angles to the long axis of the nerve fibres, it has no effect. To effect the alteration in the position of the nerve molecules which we regard as the cause of the process of excitement, the current must, therefore, pass in the longitudinal direction of the nerve. This is probably due to the peculiar electric forces of the nerve-particles, which are treated of in detail on page 215 *et seq.* Just as an electric current if it flows parallel to a magnetic needle deflects the latter, but has no such effect when it flows in a direction at right angles to that of the needle, so the nerve particles can only be disturbed from their quiescent position by currents which run parallel to the axis of the nerve. If the current is directed obliquely to the nerve fibre, it acts but not so strongly as when it is parallel, and the degree of the action decreases proportionately as the angle which the current makes with the nerve-fibre approaches more nearly to a right angle.

The connection between the phenomena of electrotonus and excitement of the nerve led us to believe that the excitement takes place, not throughout the whole portion of the nerve traversed by the current, but only in a part which on



closing is near the kathode, on opening is near the anode. This gives rise to the question, whether it is possible to expose the nerve to the action of one electrode alone. This may be done, in the case of men or other animals, by placing one electrode on the nerve, the other on a remote part of the body. If the kathode is situated on the nerve, only closing pulsations are obtained; if the anode is situated on the nerve, opening pulsations are alone observed. If the currents are very powerful, excitement may certainly occur at the point where the nerve meets the adjacent tissues. This form of nerve irritation may be called *unipolar*, though in a different sense from that in which the name is usually used in cases where only one wire is laid on the nerve, and yet currents may flow through the nerve. Such cases, however, are physiologically of no special interest.

#### 9. TANGENT GALVANOMETER (p. 162).

In the ordinary tangent-galvanometer a small magnetic needle is placed in the centre of a, comparatively, very large circle, through the periphery of which the current is made to pass. When the needle is deflected, the position of its poles does not alter essentially as regards the current, the action of which may therefore be regarded as directly proportionate to its strength; and from the opposed action of the current, and of the force of attraction which the earth exercises on the needle, which must also be regarded as constant, it is evident that the two forces must be in equilibrium, if the trigonometric tangent of the angle of deflection is proportionate to the strength of the current.

Such tangent-galvanometers are, however, only adapted for measuring powerful currents. The galvanometer which we have described, adapted for very weak currents, is different. But if, as was assumed, all the deflections which are to be measured are but very small, we may still assume that the mode of the influence of the current on the magnet is

not altered by the deflection. Then, in the case of this apparatus also, the strength of the currents may be regarded as proportionate to the tangent of the angle of deflection. A glance at fig. 19, on p. 57, shows that the displacement of the scale is equal to the tangent of the double angle of deflection. For so small an angle we may put

$$\text{tg } (2 a) = 2 \text{ tg } a,$$

that is to say, the tangent of the double angle is equal to double the tangent of the single angle. And from this it follows that the strength of the currents is proportionate to the displacement of the scale directly observed.

#### 10. TENSIONS IN CONDUCTORS (p. 133).

To determine the absolute amount of tension at any point in a conductor, it would be necessary electrically to isolate the conductor, and to connect the point in question with a sensitive electrometer. But if any point of the isolated conductor is brought into conducting connection with the surface of the earth, this point would assume a tension equal to 0, without any alteration in the differences of tension at the various points. Other points of the conductor may now be brought successively into connection with the earth, thus altering the absolute values of the tensions at the separate points, though the difference between the tensions at the various points remains the same. From this it follows that these differences are alone of importance for us. In our later explanations we have therefore represented the matter as though certain points (the boundaries between the longitudinal and cross section) had a tension = 0; that is, we always thought of them as connected with the earth. All tensions that are greater than this we call positive, all that are less negative.

### 11. DUPLEX TRANSMISSION. DEGENERATION, REGENERATION AND COALESCENCE OF A BISECTED NERVE (p. 218).

Duplex transmission has been shown in another way, but the proof is not so trustworthy and clear as that gained by the aid of negative variation. If nerves of the living animal are bisected, a striking change occurs in a very short time in the parts of the nerve-fibre below the point of scission. The medullary sheath becomes crinkled, and the excitability is lost. If, however, the cut surfaces are not too far separated, the nerve-fibres can coalesce, the lower ends again become excitable, and the excitement can be transmitted through the cicatrix thus formed in the nerve. On these facts Bidder based an experiment, in which he tried to cause a sensory nerve to coalesce with a motor nerve. The sensory nerve of the tongue (*N. lingualis*), a branch of the fifth brain nerve, and the motor nerve of the tongue (*N. hypoglossus*) cross each other below the tongue before they enter the latter. If the two nerves are cut at the point where they cross, and if the upper end of the sensory nerve, which comes from the brain, is connected with the lower end of the motor nerve, which enters the tongue, as much as possible of the two other ends of the nerves being cut out, then the two different nerves coalesce, so that after a time pulsations may be caused in the muscles of the tongue by irritation above the cicatrix, and indications of pain may be elicited by irritation below the cicatrix. The proof that in this case the excitement is transmitted downward in the upper sensory nerve, upward in the lower motor nerve, would be unassailable if it could be shown that nerve-fibres of the one nerve have not grown through the cicatrix and entered into the other nerve. This possibility, improbable as it is, cannot be disproved.

A recently published experiment of Paul Bert is founded



on a similar idea. Bert made a wound in the back of a rat, cut off a small piece of the end of the tail, and fixed the tail firmly in the wound on the back. The tail of the rat coalescing with the flesh of the back, it was attached at two points like the handle of a pot. The original root of the tail was then cut through, so that the attachment to the back alone remained. If the free end of the tail, which was originally the tail-root of the rat so treated, is pinched, the animal feels it; so that the irritation is evidently transmitted in the sensory nerves in a direction opposite to that which is usual in the tail of a rat under normal conditions, and it is accordingly evident that the sensory nerves of the tail have the power of transmitting the excitement in both directions.

## 12. NEGATIVE VARIATION AND EXCITEMENT (p. 220).

That negative variation is a constant and inseparable accompaniment of nerve-excitement has been shown by du Bois-Reymond by a large number of careful and varied experiments, which have been confirmed and extended in various directions by many observers. It makes no difference by what irritant the nerve is excited; and both motor and sensory nerves are conditioned exactly alike in this matter. From a large number of experiments to select but one of peculiar interest, I may allude to the experiment recently made with the nerve of sight. If the eye is extracted and prepared in connection with a portion of the nerve of sight, and if the latter is suitably tested as to its nerve-current, and light is then allowed to fall on the eye, previously shaded, then the current of this nerve exhibits negative variation.

If ligatures are applied to a nerve so that the excitement can no longer propagate itself from one side to the other, irritation of one side causes no negative variation in the other side. This experiment is of importance because it affords a means of proving with sufficient certainty that no

branch-currents of the electric current used for irritation, which might easily lead to errors, are present in the multiplier.

### 13. ELECTROTONUS. SECONDARY PULSATION EFFECTED BY NERVES. PARADOXICAL PULSATION (p. 221).

The reason why it is impossible to examine the electrotonus of the intrapolar portions is purely physical. If the constant current is transmitted through the portion *a k* (fig. 60, p. 220), and two points of this portion are connected with the multiplier, then a part of this current passes through the multiplier itself, so that the portion of the nerve which is situated between these points is traversed by a weaker current than are the adjacent portions. The conditions are thus rendered so complex that it becomes very hard to explain the phenomena. Other attempts to study the character of the intrapolar region have as yet afforded no clear results.

If a nerve *a* is laid on a nerve *b*, in the way shown in fig. 75, *A, B, C*, so that the nerve *b* forms a diverting arch for a portion of the nerve *a*, and if electrotonus is generated in the latter by a constant current, then the electrotonic current passes through the nerve *b*, and can at its commencement and cessation (closing and opening) excite the nerve *b*, and cause pulsation in the muscle of the nerve. This is spoken of as *secondary pulsation from the nerve*. By rapidly repeated closings and openings of the circuit, tetanus may be elicited. But this secondary pulsation is caused only by electrotonus and not by negative variation, so that it can be more easily brought about by constant currents than by inductive currents. It is thus distinguished from the *secondary pulsation effected by muscle*, which was described on p. 209. The negative variation of the nerve-current is too weak to cause any noticeable effect in a second nerve.

A special form of secondary pulsation effected through the nerve has been described by du Bois-Reymond as *paradoxical pulsation*. If a constant current is passed through the branch of the sciatic nerve to which allusion is made in Note 4, which passes to the flexor muscle of the lower leg, then the calf-muscle may also pulsate when the current is closed and

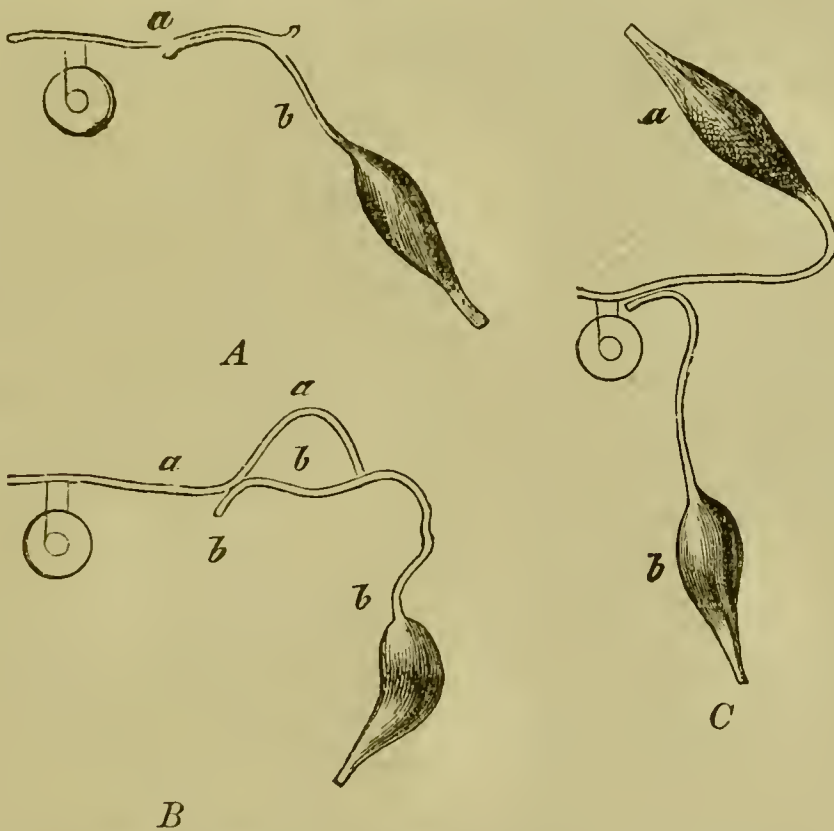

FIG. 75. SECONDARY PULSATION EFFECTED BY NERVE.

opened. This is an apparent exception to the law of the isolated transmission of the excitement (*cf.* p. 117); but actually the excitement has not passed from the irritated fibres to the adjacent fibres, but the electrotonic current of the one fibre has flowed through the neighbouring fibres and has independently irritated them.

#### 14. PARELECTRONOMY (p. 237).

The real causes of parelectronomy and the conditions under which it is more or less strongly developed, are as yet



far from being understood. But at any rate it is impossible to conceive the matter, as though the currentless condition of the muscles—that is to say, the same tension on the longitudinal and transverse sections—were normal, and as if every negativeness on the transverse section were the result of injury. For all possible degrees of parelectronomy are to be found—even the reversed order, in which the cross-section is more positive than the longitudinal section—in uninjured muscles; while in other cases the ordinary muscle-current is found powerfully developed in quite uninjured muscles. Moreover, as we have stated in the text, the question whether differences of electric tension occur in uninjured muscle has no bearing on the question whether electromotive forces are present within the muscle. We declare ourselves in favour of this hypothesis, because it most simply and easily explains *all* the phenomena. We also apply it to structures on the outer surface of which it can be proved with certainty that no differences of tension are present, as in the electric plates of fishes. For this assumption we have the same grounds on which physicists rely in claiming the existence of molecular magnets in every, even quite unmagnetic piece of iron. Whatever, therefore, may be the true explanation of parelectronomy, it cannot essentially affect our well-founded conception of the electric forces of muscles. If, however, du Bois-Reymond's supposition is confirmed, that the pulsations which occur during life leave behind them an after-effect on the muscle-ends, which makes the latter less negative, some approach would be made to an explanation of the phenomenon.

#### 15. DISCHARGE HYPOTHESIS AND ISOLATED TRANSMISSION IN THE NERVE-FIBRE (p. 249).

The explanation of the fact that the processes of excitement remain isolated in a nerve-fibre without passing into adjacent nerve-fibres, appears the more inexplicable, if

we regard these processes as electric, in that the separate fibres are not electrically isolated from each other. But the explanation which we gave of the isolated excitement of but *one* muscle-fibre by a variation of the electric current in the appropriate nerve, also explains isolated transmission in the nerve-fibres. For if the electrically active parts are very small, comparatively powerful electric action can take place in them, and yet the current may be quite unobservable at a little distance. This is a consequence of the law of the distribution of currents in irregular conductors, explained in chapter x. § 2. We must, therefore, assume that the electrically active particles situated in the axis of a nerve-fibre are small in comparison with the diameter of the fibre, and that therefore their effect at the outer surface of the fibre is already so weak that it cannot act and cause irritation in an adjacent fibre. In Note 13 we have seen that no action takes place by negative variation from one fibre on an adjacent fibre. Our multipliers are much more sensitive than nerve-fibres, so that the separate negative variations during the tetanisation of the nerve can combine their action on the multiplier; but this is impossible in the case of the excitement of nerve-fibres.







# INDEX.

## ABS

**A**BSOLUTE force of muscles, 67, 68  
Acid, formation of, in muscle, 73, 87  
Activity of muscle, 37, 202, 235; of nerve, 107, 216  
ADAMKICIEWICZ, 76  
Adequate irritants, 285  
AEBY, 100  
Albuminous bodies, 73, 80  
Ammonia, 257  
*Amœbæ*, 6  
Amœboid movements, 7  
Anelectrotonus, 129, 141  
Animal, 5  
Anode, 128, 220  
Arches, diverting homogeneous, 177, 181  
ARISTOTLE, 155, 285  
Ascending currents, 134  
Attachment of muscles, 17  
Automatic movement, 271  
Avalanches, 250  
Avalanche-like increase in the excitement of nerves, 122, 300  
Axis-band, 104  
Axis-cylinder, 104

**B**ACON as food, 85  
Ball-sockets, 19, 93  
BÉCLARD, 73  
BERNARD, 253

## CHE

BERNSTEIN, 100, 219  
BERT, 312  
Blood, 78, 273  
Blood-corpuscles, 7  
Blood-vessels, 96, 272  
DU BOIS REYMOND, 25, 30, 35, 36, 53, 59, 73, 87, 111, 150, 156, 165, 181, 183, 186, 205, 208, 217, 230, 248, 278, 313, 315, 316  
Bones, 17, 18, 93  
Branched muscle fibres, 101  
Branching of electric currents, 132, 150  
Brownian movements, 3  
BRÜCKE, 89  
Burden, 23, 39, 64  
BURDON-SANDERSON, 223

**C**ALF-MUSCLE. *See* Gastrocnemius  
Carbonic acid, formation of, in muscle, 42, 73, 81  
Carrying-height (Traghöhe) 41  
Cells, 9. *See also* Nerve-cells  
Central-organ of the nervous system, 103, 117, 265  
Centrifugal and centripetal nerves, 266  
*Cerebrum*, 277  
Chamois-hunters, 85  
Chemical composition of muscles, 73

## CHE

- Chemical irritants, 30, 109, 257  
 Chemical processes in muscle, 42, 73  
 Ciliary cells, 10  
 Ciliary-movements, 10  
 Circuit, electric, 159, 165  
 CLAUDIUS CLAUDIANUS, 155  
 Closing of a current, 32, 132, 304  
 Closing inductive current, 151, 299  
 Combination of tensions, 228 ; of irritants, 299  
 Compensation, 183  
 Compensator, round, 186  
 Conception, 279, 286  
 Conine, 253  
 Conscious sensation, 277  
 Conservation of energy, 77  
 Constant currents, 34, 109, 126, 131  
 Correlative action, 270  
 Correlative sensation, 276  
 Creatin, 74  
 Cross-section of the muscle, 66, 190, 198, 208, 236, 256 ; of the nerves, 120, 216, 256  
 Curare, 253  
 Current-curves, 178  
 Current-planes, 179  
 Curve of excitability, 121, 300
- D**ARWIN, 224  
 Death of the muscle, 86, 207 ; of the nerve, 120, 124  
 Death-stiffness, 87  
 Degeneration of a cut nerve, 312  
 Descending currents, 134  
*Dionæa muscipula*, 149, 224  
 Discharge-hypothesis, 248, 316  
 Discs of muscle-fibres, 14  
 Disdiaclasts, 15, 102  
 Dislocation of the neck, 273  
 Diverting arches, 177  
 Diverting cylinders, 181  
 Diverting vessels, 166  
 Division of electric currents, 132, 170  
 DONDERS, 289  
 Dorsal marrow, 106, 277

## FIB

- Double refraction, 15  
 Duplex transmission, 217, 312  
 Dynamite, 251  
 Dynamometer, 69
- E**LASTICITY, 21 ; alteration of, on contraction, 44, 70 ; co-efficient of, 23 ; law of, 22  
 Electric current, 159  
 Electric eel, 156  
 Electric fishes, 154, 222, 227, 241  
 Electric irritation, 32, 109, 149, 151  
 Electric organs, 158, 222  
 Electric plates, 158, 222, 227, 241  
 Electric ray, 156  
 Electric wheel, 33  
 Electrodes, 128 ; unpolarisable, 181  
 Electromotive force, 168, 232 ; of the muscles and nerves, 153, *et seq.*  
 Electromotive surface, 179, 227  
 Electrotonus, 127 ; 139, 220, 238, 309, 314  
 Element. *See* Muscle-element and Nerve-element  
 Elementary organisms, 8  
 Energy, 41, 50, 64, 72, 77 ; specific, 286  
 ENGELMANN, 100  
 Equipoise, unstable, 250  
 Equator, electromotive, 190  
 ERMANN, 45  
 Excitability, 119, 122, 126, 299, 300  
 Excitement, 126, 144, 150, 151, 313  
 Exhaustion, 79, 121  
 Extension, 21, 92, 295 ; gradual, 24  
 Extrapolar regions, 220
- F**ARADAY, 156  
 Feet of the diverting arch, 176  
 Fibres. *See* Muscle-fibres and Nerve-fibres  
 Fibre-cells, 96

## FIB

Fibrillæ, 14  
 FICK, 41, 299, 309  
 Fish, electric, 154, 222, 227, 241  
 Flat-bones, 18  
 Flesh, 2, 11, 86  
 Force, electromotive, 168, 232  
 Force, muscular, 50, 67  
 Forms of muscles, 91  
 Form, changes of, in muscle during contraction, 45  
 Freeing of forces, 249  
 Function, 293

**GALVANOMETER**, 160  
 Ganglion-cells. *See* Nerve-cells

Ganglion-balls. *See* Nerve-cells  
*Gastrocnemius*, 17, 67, 109, 199, 200, 203, 209, 302

GAUSS, 58

GERLACH, 246, 247, 259

Gizzard, 96

Glands, 212, 227, 262

Glycerine, 257

Glycogen, 73, 80, 87

GOETHE, 285

Graphical representation, 293

S'GRAVESANDE, 23

Grey nerve-fibres, 104

Gunpowder, 250

*Gymnotus*, 156

**HALLER**, 252

Hallucination, 279

HARLESS, 253

Head of muscle, 13

Heart, the, 101, 210

HEIDENHAIN, 76, 146

Height of elevation, 37, 297

HELMHOLTZ, 50, 52, 59, 73, 75, 115, 228, 287, 290, 306

HERMANN, 70, 100

Hinge-socket, 19, 93

HIRSCH, 288

Homogeneity of all nerve-fibres, 263

HOOK, 23

HUMBOLDT, 156

Hypotheses, 229, 234

## MAG

**I**NCREASE in thickness of muscle on contraction, 44

Induction, magnetic, 243

Inductive currents, 31, 110, 139, 304, 308

Induction coil, 31, 35, 119, 306

Inertia of consciousness, 290

Inosit, 74, 87

Internal work during tetanus, 41, 76, 77

Intestine, 96, 272; of the tench, 101

Intrapolar regions, 129, 221

Involuntary movements, 271

Irregular movements, 272

Irritants, 30, 109

Irritability, 30, 108; independent, 255

Isolated transmission in the nerve-fibre, 117, 315

Isoelectric curves. *See* Tension-lines

**KATELECTROTONUS**, 129, 141

Kathode, 128, 220

Kernel (nucleus) 5, 7, 11, 16, 96, 105

Key, tetanising, 36

Kleistian jar, 30

KÖLLIKER, 253

KRONECKER, 299

KÜHNE, 89, 256, 257

**L**ABOUR accumulator, 41

Lactic acids, 73, 80, 87, 258

Latent irritation, 56, 64

Law of eccentric sensation, 280

Law of pulsations, 135, 142

Leverage of bones, 93

Leyden jar, 30

Life centres, 272

Light, 15, 284

Long bones, 18

**M**AGNET, compared to muscle and nerve, 147, 230, 260



## MAL

- Malapterurus*, 156  
 MATEUCCI, 229  
 Mechanical irritants, 30, 109, 146  
 Medullary sheath, 104, 245, 254, 263  
*Mimosa pudica*, 2, 224  
 Mirror, reading of small angles by means of, 57, 162  
 Modification of excitability, 131, 143  
 Molecular hypothesis, 238  
 Molecular movement, 3  
 Mollusca, 102  
*Mormyrus*, 159.  
 Motor nerves, 261  
 Movement, 1; in plants, 2, 8, 224; of the smallest organisms, 4; molecular, 3; protoplasmic, 6; amœboid, 6; ciliary, 9; muscular, 9 *et seq.*; peristaltic, 98, 272; voluntary and involuntary, 98, 275; automatic, 273; rhythmic, 272; tonic, 272  
 MÜLLER, 285  
 Multiplier, 161  
 MUNK, 116, 224, 300  
 Muscle, 2, 11, 12 *et seq.*, 189 *et seq.*, 226 *et seq.*  
 Muscle-current, 191, 202, 226  
 Muscle-element, 232, 239  
 Muscle-fibre, striated, 14, 45, 96, 245; smooth, 96, 101; zigzag arrangement of, 14  
 Muscle-fibre pouch. *See* Sarcolemma  
 Muscle-fluid, 88  
 Muscle-prism, 189, 230, 234  
 Muscle-rhombus, 193, 195, 230  
 Muscle-note, 43, 211  
 Muscle-telegraph, 30  
 Myograph, 26, 37, 52, 100, 111  
 Myosin, 74, 90
- NASSE, 73  
 Negative variation, 203, 210, 214, 216, 226, 235, 313  
 Nerve-cells, 103, 266, 269

## POL

- Nerve-centres. *See* Central Organs.  
 Nerve-current, 215, 226, 236  
 Nerve-element, 237 *et seq.*  
 Nerve-fibres, 103 *et seq.*; termination of, in muscles, 245  
 Nerve-net, 246  
 Nerve-processes, 107, 265  
 Nerve-sheath, 104, 111  
 Nerve, terminal plates of, 245  
 Nervous system, 103  
 Nettle, stinging, movements in hairs of, 8  
*Neurilemma*. *See* Nerve-sheath  
 Neutral point, 129  
 Nicotin, 253  
 Nitroglycerine, 250, 251  
*Nucleolus*, 105  
 Nutriment of labourers, 82  
 Nut-socket, 19, 93
- OPENING of a current, 32, 131, 308  
 Opening induction-current, 150, 304  
 Opening-tetanus, 132, 143  
 OPPIAN, 155  
 Organs. *See* Central Organs and Electric Organs  
 Over-burden, 65  
 Oxidation, process of, in muscle, 42
- PARADOXICAL pulsation, 314  
 Parelectronomy, 208, 236, 315  
 Penniform muscles, 91, 199  
 Peripheric nerves, 103, 107  
 Peristaltic movement, 98, 272  
 PFLÜGER, 122, 140  
 Physiological time, 288  
 Plants, movements of, 2, 9, 224; electric action of, 153, 223 *et seq.*  
 Plates, electric, 158, 222, 227, 241  
 PLINY, 155  
 POGGENDORF, 183  
 Polarised light, 15

## PRE

- PREVOST and DUMAS, 45  
 Prism. *See* Muscle Prism  
 Propagation, of the pulsation  
 within the muscle-fibre, 99;  
 of the irritation within the  
 nerve-fibre, 110, 114, 287; of  
 the negative variation in the  
 nerve-fibre, 129  
 Protoplasm, 5  
 Protoplasmic movement, 6  
 Protoplasmic processes, 106  
 Pulsation, 31, 56, 210; secondary,  
 210, 314; law of, 135, 142, 299

**RADIATION** of sensations, 276  
 Rate of excitement in the  
 nerve-fibre, 98; of transmission  
 within the nerve-fibre, 110, 114,  
 129, 287

- Reaction in muscles, 87  
 Receptive apparatus of sensory-  
 nerves, 283  
 Reflection, 290  
 Reflex actions, 274, 290, 301  
 Respiratory movements, 272  
 Respiratory centre, 272  
 Rest of muscles, 37  
 Retardation (*Hemmung*), 80  
 Retardatory nerves, 263  
 Rheochord, 133, 149, 184  
 Rhombus. *See* Muscle-rhombus  
 Rhythmic movements, 272, 281  
 Ritter's tetanus, 132, 143

**SARCOLEMMA**, 16, 101, 233  
 SCHWANN, 70

- Secretory nerves, 213, 262  
 Secondary pulsation, 210, 314  
 Secondary tetanus, 211  
 Semi-penniform muscles, 91  
 Sensation, 1, 262  
 Sensitive machines, 251  
 Sensitive plant, 2  
 Shaft of a bone, 19  
 Short bones, 18  
 Shortening of muscles 12, 28

## TRU

- Skeleton, muscles of, 13  
 Skin-currents, 207, 213  
 Sliding inductive apparatus, 35,  
 119  
 Smooth muscle-fibres, 12, 96, 206  
 Sockets, 19, 93  
 Source of muscle-force, 42  
 Specific energies, 286  
 Specific warmth, 76  
 Steam engine, comparison of,  
 with muscle, 82  
 Stinging-nettles, movements in  
 hairs of, 8  
 STRAUSS, 290  
 Striated muscle, 11 *et seq.*  
 Sugar, 73, 80, 85  
 Surface, electromotive, 179, 227

- TAIL** of muscle, 13  
 Tangent galvanometer, 162,  
 310  
 Temperature, influence of, on  
 muscles and nerves, 86, 124  
 Tench, 101  
 Tension, electric, 168, 171, 229,  
 311  
 Tension-curves, 179, 190  
 Tension, differences of, 182, 311  
 Tension-lines, 179, 190  
 Tension-surfaces, 179  
 Terminal apparatus of nerves,  
 262, 267  
 Tetanus, 34, 37, 41, 109, 300;  
 secondary, 211, 314  
 Thermic irritants, 109  
 Thermo-electricity, 74  
 TIEGEL, 300, 309  
 Time, measurement of, 51, 61, 98,  
 111, 115, 131, 288  
 Tonic contraction, 272  
*Torpedo*, 155, 158  
 Transmission, in the nerve-fibre,  
 110, 141, 287; isolated, 117,  
 316; duplex, 217, 312  
 Transverse currents through the  
 nerves, 309  
 Trunk of a muscle, 13

## UNI

- UNIPOLAR irritation, 309  
 Unpolarisable electrodes, 181  
 Urinary duct, 100  
 Urea, 80, 84
- VASO-MOTOR nerves, 261  
 Volume of muscle, 45, 66
- WAGNER'S hammer, 34, 306  
 Warmth equivalent, 76, 81

## WOR

- Warmth, generation of, in muscle,  
 42, 73, 74; in nerve, 123  
 WEBER, 45, 263  
 WEISS, 73  
 Whip-cell movement, 11  
 Will, 270, 290; deflection of  
 magnetic needle by, 205  
 Woodcutters, Tyrolese, 85  
 Work accomplished by the  
 muscle, 37, 38, 72, 76, 296













